

KYRYA[®]

23

TARIFA TÉCNICO

ES





KYRYA® es una compañía líder en la fabricación de mobiliario de baño a medida y personalizado. Somos inconformistas y trabajamos con la motivación de seguir desarrollando nuestra capacidad de generar nuevos conceptos y construir asociaciones con nuevas ideas que den lugar a soluciones innovadoras y atractivas.

El diseño es nuestra actitud. Y nuestro trabajo es la mejor forma de demostrarlo, haciendo de éste, un sello de identidad que queda grabado en cada uno de nuestros proyectos.

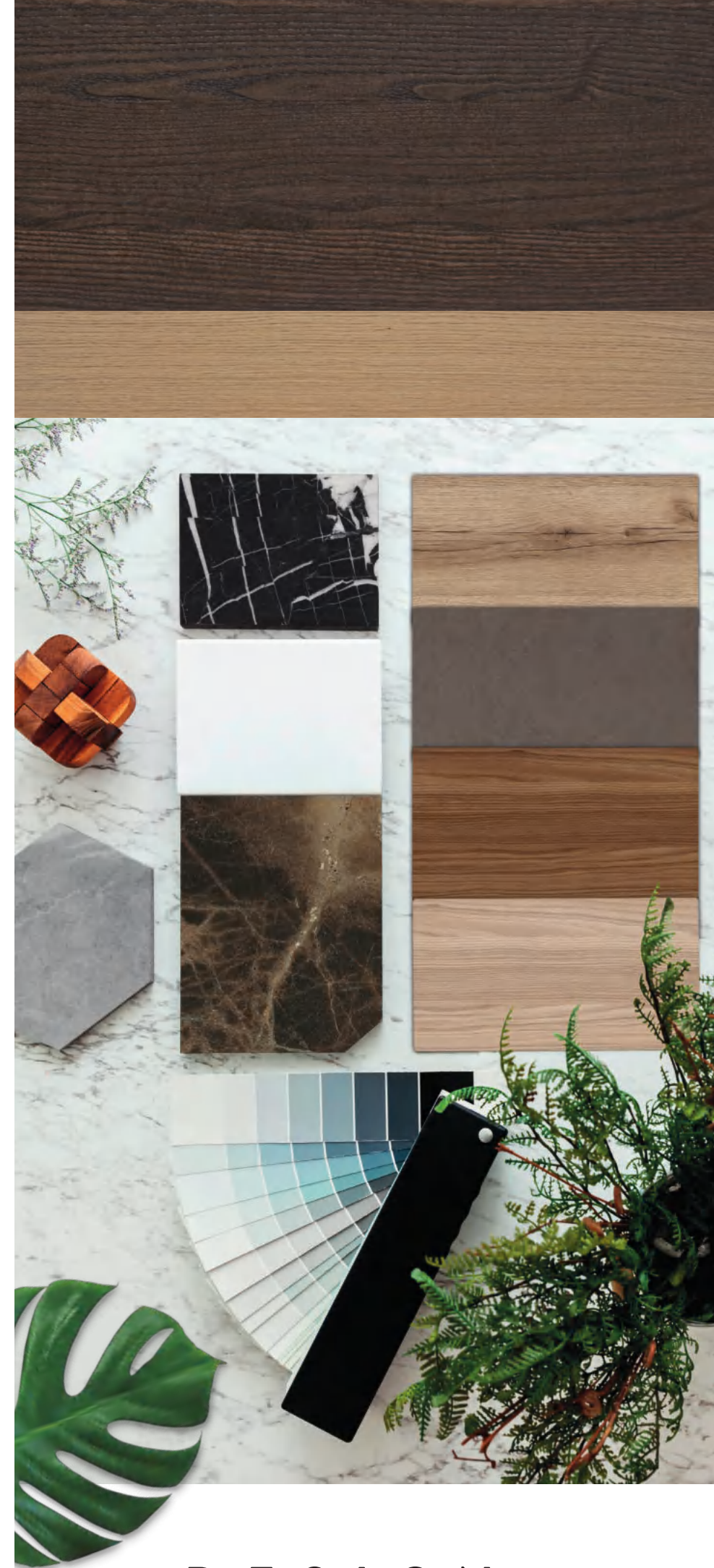

CUSTOMISED
INDIVIDUALISED
DESIGN SYSTEM,
ATTENTION PAID TO
EVERY LAST DETAIL.

DESIGN
ATTITUDE

Services 24/7

Kyrya Group apuesta por la digitalización de todos los documentos con el fin de mejorar el servicio al cliente y sumarnos a la protección del medio ambiente reduciendo el consumo de papel.

Tus pedidos

Podrás realizar el seguimiento de los pedidos por tu propia referencia, consultar el estado de fabricación y fechas de entrega. Ver trazabilidad y visualización online de los envíos con conexión directa con la agencia de transportes. Posibilidad de descargar los documentos disponibles.

Área técnica

En la plataforma, están las fichas técnicas e instrucciones de montaje de todos nuestros productos. Dentro de las mismas encontrarás toda la información técnica, rangos de medidas disponibles, así como las opciones de personalización de estos. Para realizar tus pedidos disponemos de plantillas que facilita la generación del pedido de forma más rápida y sencilla sin olvidar ningún dato necesario para la fabricación.

Documentación gráfica

Todos nuestros catálogos y tarifas están centralizados en el área pro para que puedas acceder y descargar en cualquier momento y en cualquier lugar.

Inspiración y recursos

Tienes a tu disposición una fuente de inspiración con imágenes, vídeos y otros recursos digitales interactivos para coger ideas, gracias al amplio abanico que nos brindan todas las marcas y las posibilidades de personalización según necesidad y totalmente a medida.

My Kyrya TU DISEÑAS NOSOTROS FABRICAMOS

MyKyrya es un programa web 3D, que te permitirá presentar un proyecto del baño elegido con imágenes en 3D, junto con su presupuesto y planos. Además, podrás ver en movimiento la apertura de cajones y puertas con un solo click, incorporar a la escena elementos tales como ventanas, sanitarios, el acabado de paredes y suelo, e incluso la planta de la estancia, para obtener un reflejo perfectamente fiel de tu proyecto que podrás modificar cuantas veces quieras.

Códigos QR

Los códigos QR que encontraras en las tarifas y en nuestros productos te permitirán a través de tu dispositivo móvil acceder de forma rápida a toda la información.

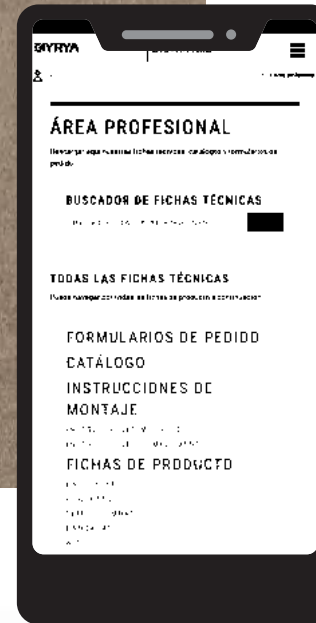

TODO A UN CLICK
El área profesional para consultar y gestionar de forma rápida y sencilla todas tus necesidades
24h /7 días

Tus pedidos
Estado de tus pedidos y trazabilidad.



Área técnica
Fichas técnicas
Instrucciones de montaje
Plantillas de pedido.



Inspiración y recursos
Imágenes y composiciones en formato digital interactivo.



Documentación gráfica
Catálogos y tarifas.



Configurador web 3D
TU DISEÑAS - NOSOTROS FABRICAMOS



MUEBLES A MEDIDA Y PERSONALIZADOS

Una forma única de fabricar un equipamiento singular

Trabajamos bajo pedido

Un pedido, un producto y un proceso de fabricación específico para darle su forma final.

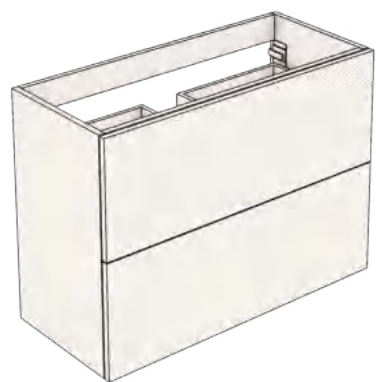

ELECCIÓN DE MUEBLE

Selecciona la distribución y medida (ancho, alto y fondo) de tu mueble de baño entre los diseños que KYRYA propone.



ELECCIÓN DE ACABADOS

Personaliza el exterior de mueble KYRYA, eligiendo entre las cinco familias de acabados; Fantasía, Arlux, Fenix, Madera y Laca.



ELECCIÓN DE ESTRUCTURA

KYRYA ofrece 6 opciones diferentes de estructuras de mobiliario. Agrupadas en Classic, Barras y Cuadro.



ELECCIÓN DE APERTURA Y ACCESORIOS

KYRYA nos ofrece una gama de 25 tiradores y uñeros para personalizar el sistema de apertura. También disponemos de accesorios con los que mejorar la forma de almacenamiento, iluminación y otros complementos.



ELECCIÓN ENCIMERAS Y LAVABOS

KYRYA nos ofrece un gran abanico de encimeras con **lavabo integrado** y **lavabos sobre encimera** en Durian, Pivstone y Porcelana.



ELECCIÓN DE ESPEJOS Y COMPLEMENTOS

KYRYA crea tendencia en el cuarto de baño con una amplia variedad de espejos con formas, retroiluminados y decorativos, así como la iluminación de lámparas colgantes y apliques.



SISTEMA DE CAJONES

KYRYA® ofrece la posibilidad de elegir entre los sistemas de cajón GRASS® **STANDARD** con tensores sin incremento y **SCALA** con laterales finos con incremento +25 €/und.

En ambos modelos el acabado de los laterales metálicos es **STONE** y **SKIN SOUL** su base.



FRENA CON SUAVIDAD



GARANTÍA DE APERTURA



MUY RESISTENTE



VARIEDAD MEDIDAS



TAMAÑO GUÍA SEGÚN FONDO DE MUEBLE



PARA BAJO LAVABOS

CAJÓN	FONDO 50	FONDO 45	FONDO 40	FONDO 35
STANDARD SUPERIOR	guía 40	guía 35	guía 30	guía 27
STANDARD INFERIOR	guía 45	guía 40	guía 35	guía 30
SCALA SUPERIOR	guía 40	guía 35	guía 27	guía 27
SCALA INFERIOR	guía 45	guía 40	guía 35	guía 27

PARA COQUETAS

CAJÓN	FONDO 50	FONDO 45	FONDO 40	FONDO 35
STANDARD SUPERIOR	guía 45	guía 40	guía 35	guía 30
STANDARD INFERIOR	guía 45	guía 40	guía 35	guía 30
SCALA SUPERIOR	guía 45	guía 40	guía 35	guía 27
SCALA INFERIOR	guía 45	guía 40	guía 35	guía 27

- Ver medidas máximas y mínimas en ficha técnica.
- Ancho mínimo de cajón 30 cm.
- Las guías en muebles con vaciado sanitario tienen el mismo fondo.

TAMAÑO GUÍA SEGÚN TIPO DE DESAGÜE

SIFÓN ESTÁNDAR

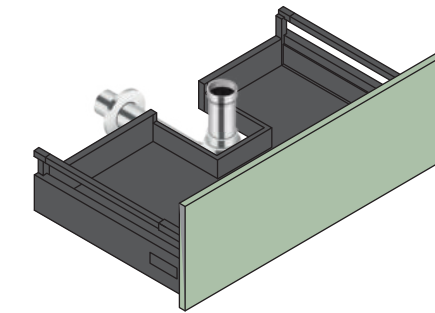
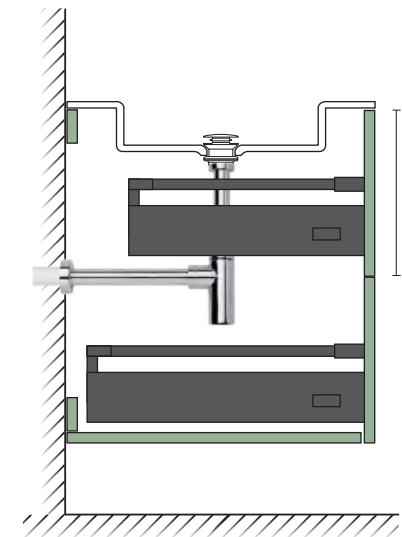

VACIADO SANITARIO

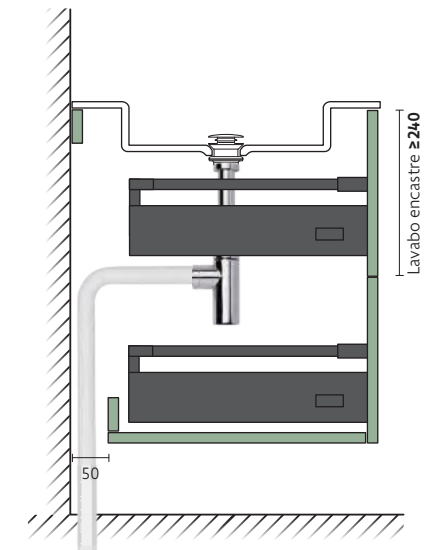

CAJÓN SUPERIOR

KYRYA® te da la opción de personalizar el cajón superior eligiendo entre las diferentes opciones de sifón, para aumentar su capacidad.



CAJÓN INFERIOR

KYRYA® te ofrece de serie la mayor capacidad de almacenamiento del mercado aumentando 5 cm. su fondo (excepto en vaciado sanitario).

SIFÓN ESPACIO

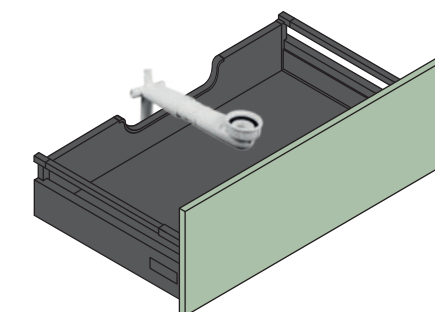
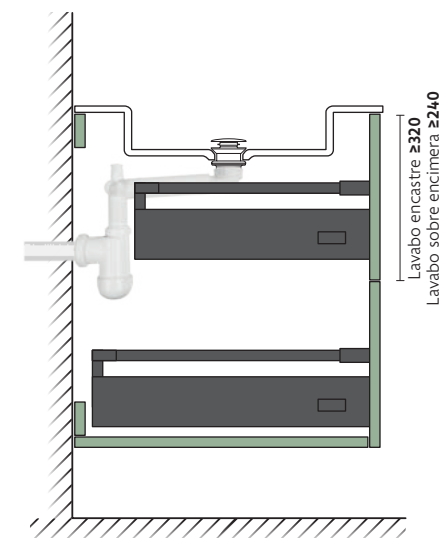

MÁXIMO APROVECHAMIENTO DEL CAJÓN SUPERIOR

SIFÓN SECO

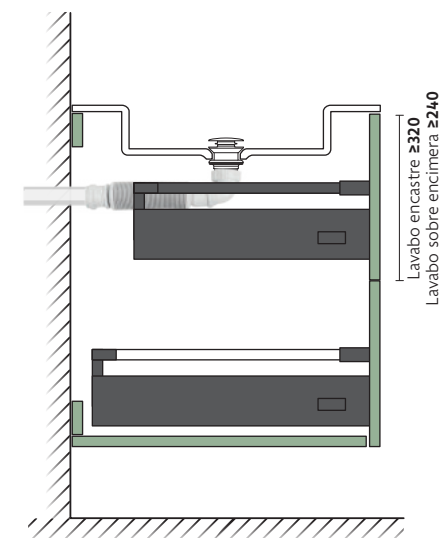

01

ESTRUCTURAS/
SISTEMAS DE APERTURA

04

REPISAS/
ENCIMERAS/
BANCADAS

07

ESPEJOS/
CAMERINOS/
ILUMINACIÓN

02

BAJO LAVABOS

05

COMPLEMENTOS/
FRENTE VITRINAS/
ESTRUCTURAS

08

ENCIMERAS/
LAVABOS

03

COQUETAS
MODULARES

06

ALTOS/
COLUMNAS

09

ACABADOS

01.

ESTRUCTURAS Y SISTEMAS DE APERTURA

estructuras



CLASSIC



BARRAS 2



CUADRO 2 ABIERTO



BARRAS 1



CUADRO 1 ABIERTO



BARRAS 3 CURVO

sistemas de apertura

uñeros



INGLETE METÁLICO



OLA METÁLICO



ANSO



GOLA



GOLA LED

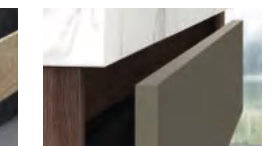

RECTO

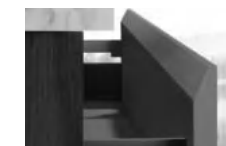

INGLETE

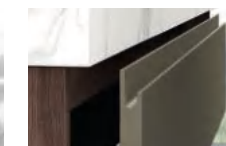

OLA

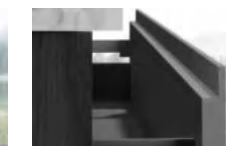

ELE

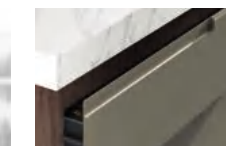

LARA



HADA BICOLOR



PUSH

tiradores



REA



NEW STANDARD

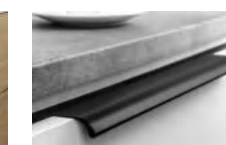

GINA



DIANA



CRISTINA



CRISTINA MADERA



BEA



BRUNA



ELSA



PAOLA



CARMEN

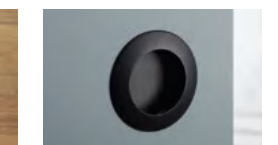

HELEN



ESTRUCTURAS



Classic, estructura tradicional donde el frente cierra sobre el armazón. Nos permite crear desarrollos modulares para adaptarnos a todos los espacios.

Barras 2, estructura que envuelve los frentes lateralmente, creando una solución para evitar obstáculos laterales.

Cuadro 2 abierto, estructura que crea un perímetro alrededor de los frentes, enmarcando el mobiliario.

La elección de la estructura no condiciona el acabado del frente.

barras 2

COMPACTO

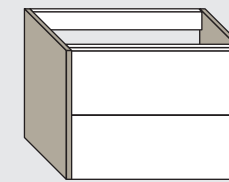

MODULAR

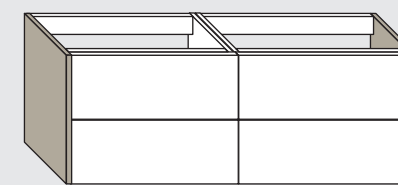

• Laterales de 2 cm. de grosor.

FANTASÍA	ARLUX	FENIX	LACA	MADERA
✓	✓	✓	✓	✓

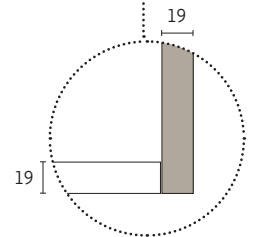

classic

COMPACTO

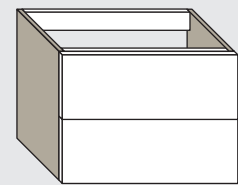

MODULAR

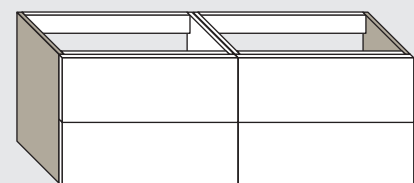

• De no indicar lo contrario los muebles serán fabricados en estructura Classic con las fajas en el mismo acabado.

FANTASÍA	ARLUX	FENIX	LACA	MADERA
✓	✓	✓	✓	✓

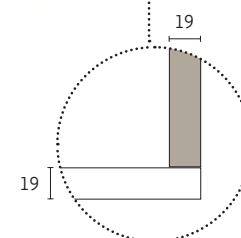

cuadro 2 abierto

COMPACTO

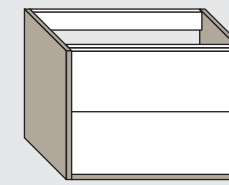

MODULAR

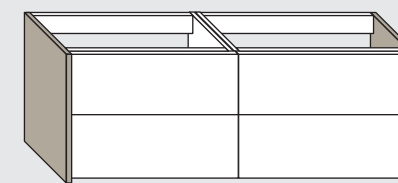

• Perímetro de 2 cm. de grosor.

FANTASÍA	ARLUX	FENIX	LACA	MADERA
✓	✓	✓	✓	✓

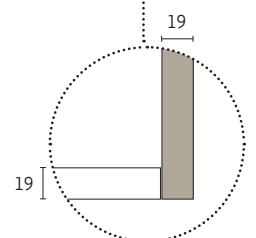



Barras 1 y Barras 3 curvo, estructura que envuelve los frentes lateralmente, creando una solución para evitar obstáculos laterales.

Cuadro 1 abierto, estructura que crea un perímetro alrededor de los frentes, enmarcando el mobiliario.

Las estructuras están disponibles en laca y madera, pudiéndose combinar con frentes en cualquiera de los acabados que KYRYA® ofrece.

La elección de la estructura no condiciona el acabado del frente.

cuadro 1 abierto

COMPACTO

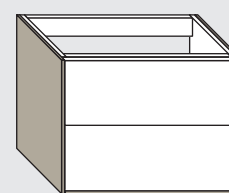

MODULAR

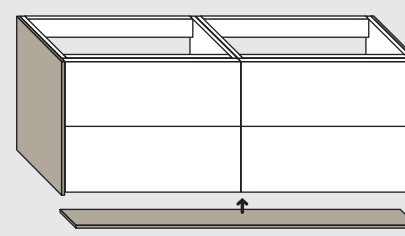

• Perímetro de 1 cm. de grosor.

	FANTASÍA	ARLUX	FENIX	LACA	MADERA
FRENTE	✓	✓	✓	✓	✓
ESTRUCTURA	+165				

▲ Laterales y base aplacados de 1,2 cm., siempre en Madera o Laca.

barras 1

COMPACTO

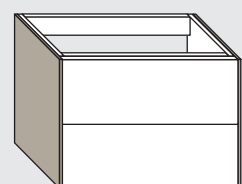

MODULAR

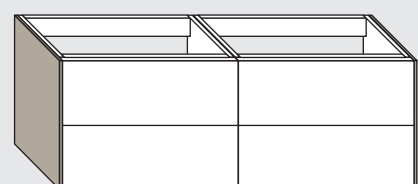

	FANTASÍA	ARLUX	FENIX	LACA	MADERA
FRENTE	✓	✓	✓	✓	✓
ESTRUCTURA	+110				

▲ Laterales aplacados de 1,2 cm., siempre en Madera o Laca.

barras 3 curvo

COMPACTO

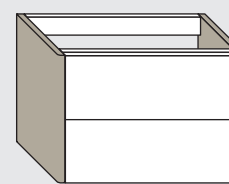

MODULAR

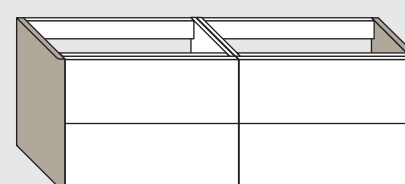

• Sólo para encimera Durian® y Pivstone®.

	FANTASÍA	ARLUX	FENIX	LACA	MADERA
FRENTE	✓	✓	✓	✓	✓
ESTRUCTURA	+135				

▲ Laterales de 3 cm., siempre en Laca.



SISTEMAS DE APERTURA

UÑEROS Y TIRADORES

Las calles vistas tienen 3 cm. de altura y se considera medida de frente.

Posibilidad de elegir entre cualquier modelo de uñero o tirador sin incremento, salvo Push, Cristina y Gola Led.

De no indicar lo contrario los uñeros se suministrarán en **Posición 1 (P1)** excepto Gola y uñero recto en **Posición 2 (P2)** para fondos ≤ 47 cm.

Las medidas de tirador indicadas en esta tarifa, se refieren a la cota exterior.

Cambio de posición o medida de tiradores +30€/mueble, (ver cuadro técnico).

Los tiradores cuando van en cajones se posicionan centrados y en puertas se posicionan desplazados.



inglete metálico

CON CALLE

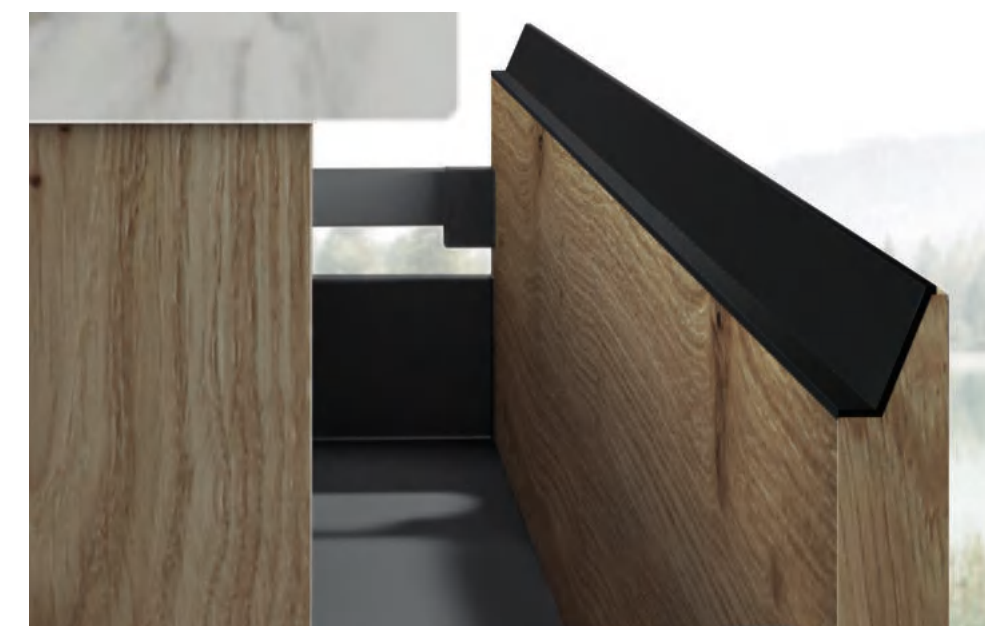
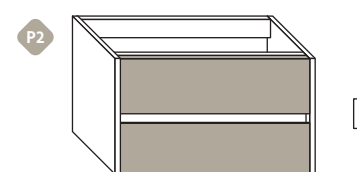
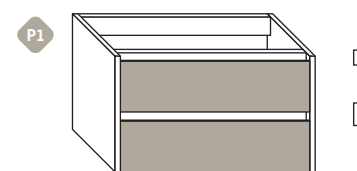

PLATA BRILLO



NEGRO

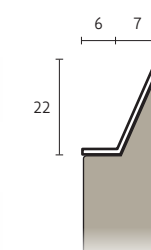

FANTASÍA	ARLUX	FENIX	LACA	MADERA
✓	✓	✓	✓	✓



Más información e instrucciones de montaje.

ola metálico

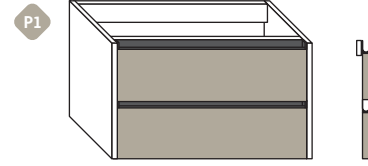

El uñero tiene la misma medida de la anchura del frente.

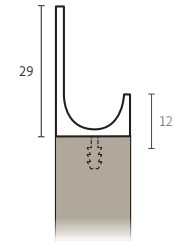

FANTASÍA	ARLUX	FENIX	LACA	MADERA
✓	✓	✓	✓	✓

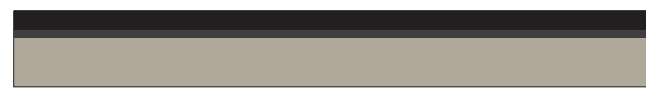

gola

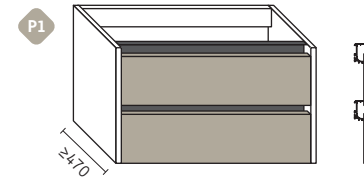

Posición 1
Para fondo de mobiliario igual o superior a 47 cm., excepto lavabo sobre encimera.

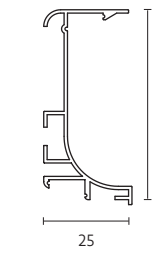
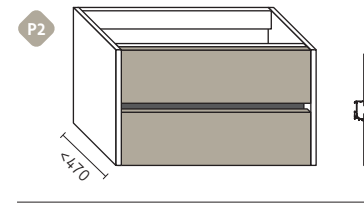

FANTASÍA	ARLUX	FENIX	LACA	MADERA
✓	✓	✓	✓	✓

• Se puede suministrar Gola corrido sin led hasta 200 cm.

anso

CON CALLE

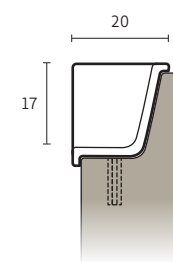
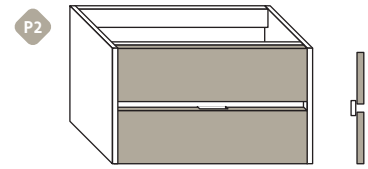
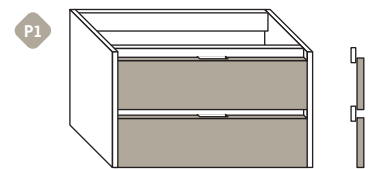

FANTASÍA	ARLUX	FENIX	LACA	MADERA
✓	✓	✓	✓	✓

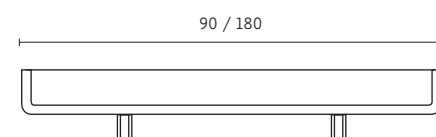

gola led

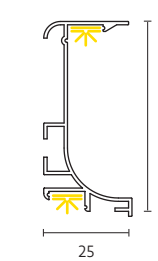
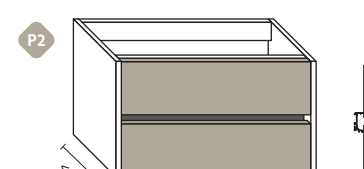
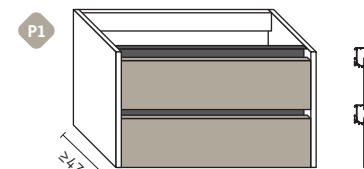

FANTASÍA	ARLUX	FENIX	LACA	MADERA
+195				

- Led interior accionado mediante sensor de apertura y cierre.
- Temperatura de la luz 4000°K.
- No válido para muebles compactos, ver ficha técnica.



recto

CON CALLE

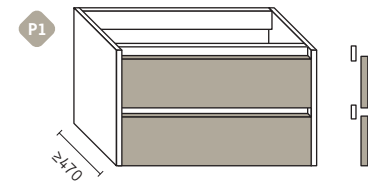

Posición 1
Para fondo de mobiliario igual o superior a 47 cm., excepto lavabo sobre encimera.

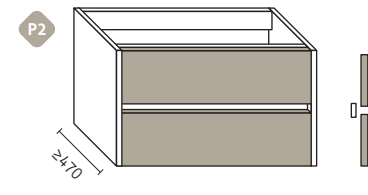

FANTASÍA	ARLUX	FENIX	LACA	MADERA
✓	✓	✓	✓	✓

ola

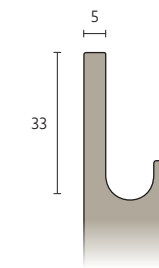
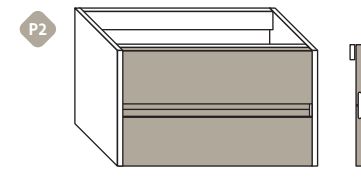
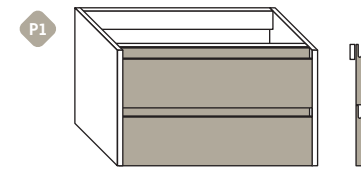

FANTASÍA	ARLUX	FENIX	LACA	MADERA
✗	✗	✗	✓	✗

inglete

CON CALLE

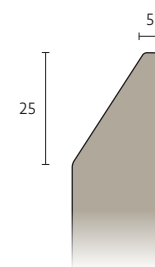
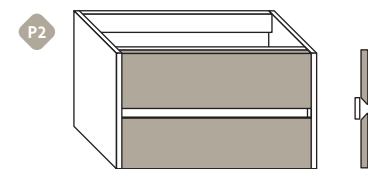
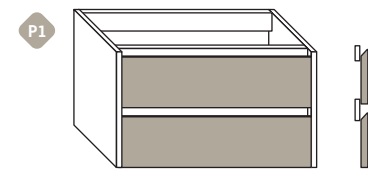

FANTASÍA	ARLUX	FENIX	LACA	MADERA
✗	✗	✗	✓	✓

ele

CON CALLE

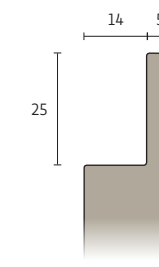
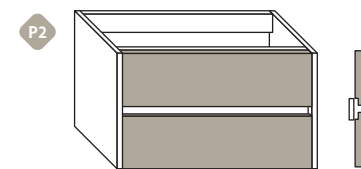
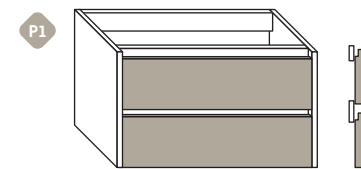

FANTASÍA	ARLUX	FENIX	LACA	MADERA
✗	✗	✗	✓	✗



lara

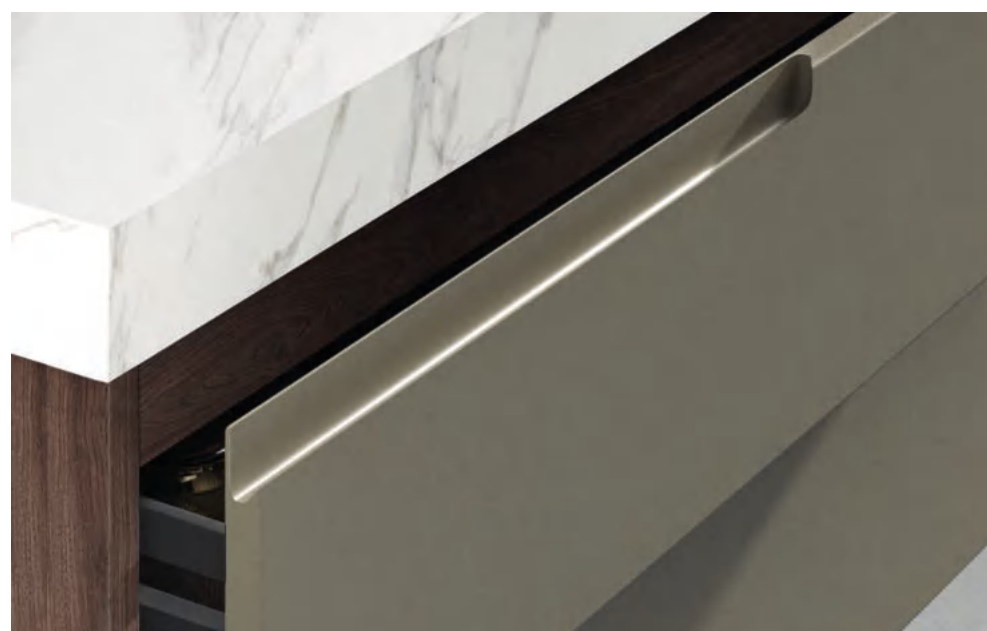
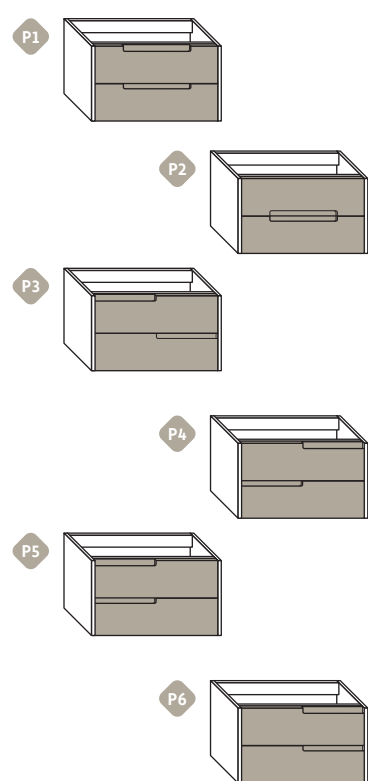

La medida del uñero equivale a la mitad del frente.
De no indicar lo contrario se suministra en P1.

FANTASÍA	ARLUX	FENIX	LACA	MADERA
X	X	X	✓	X



hada bicolor

CON CALLE

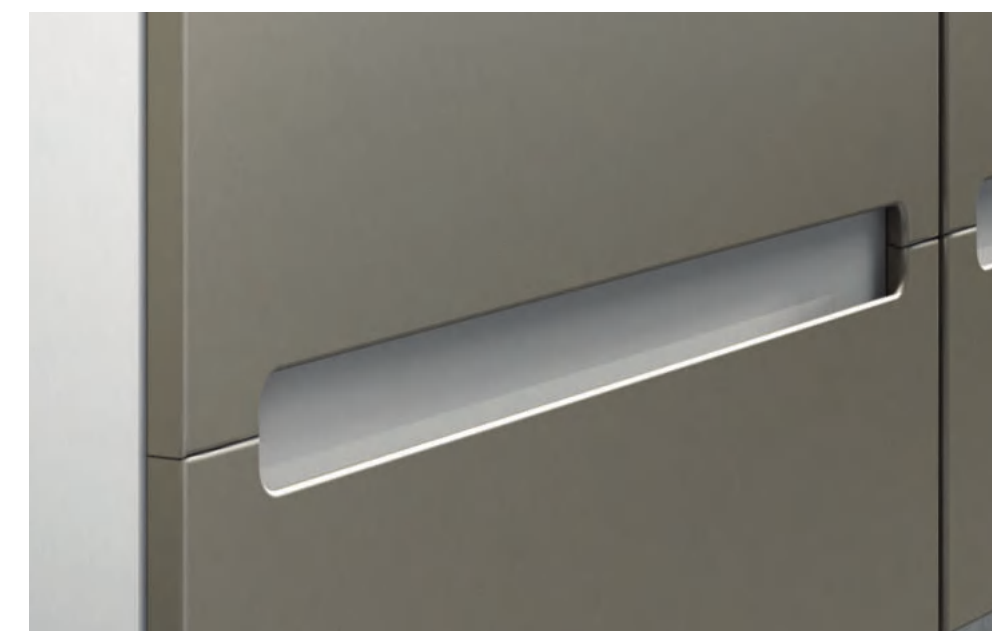
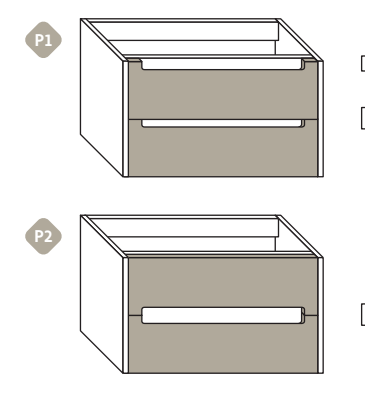

La medida del uñero equivale a 5 cm. menos por cada lado que el frente.



FANTASÍA	ARLUX	FENIX	LACA	MADERA
X	X	X	✓	X

push

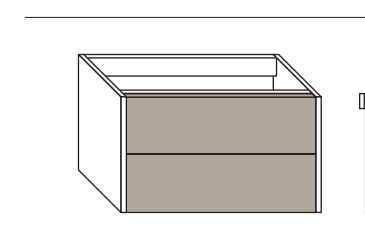

Sistema de apertura exclusivo para cajón SCALA con barra estabilizadora. Precio push con suplemento de la guía incluido.
Ancho mínimo de cajón 30 cm.

	FANTASÍA	ARLUX	FENIX	LACA	MADERA
CAJÓN			+60/und.		
PUERTA			+25/und.		



rea

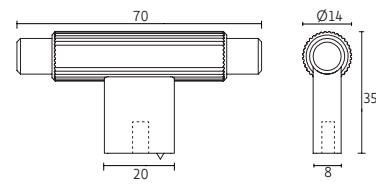

FANTASÍA	ARLUX	FENIX	LACA	MADERA
✓	✓	✓	✓	✓

• Opción 2º unidad/frente +50€

gina

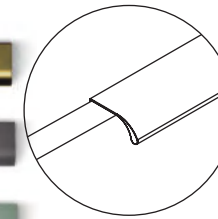
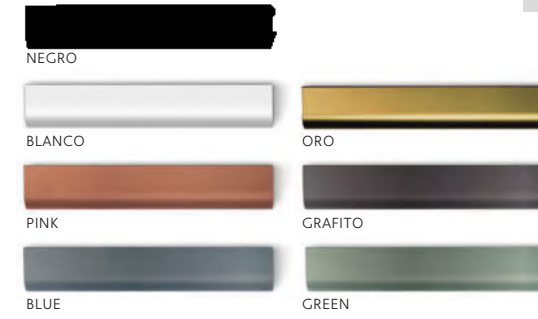
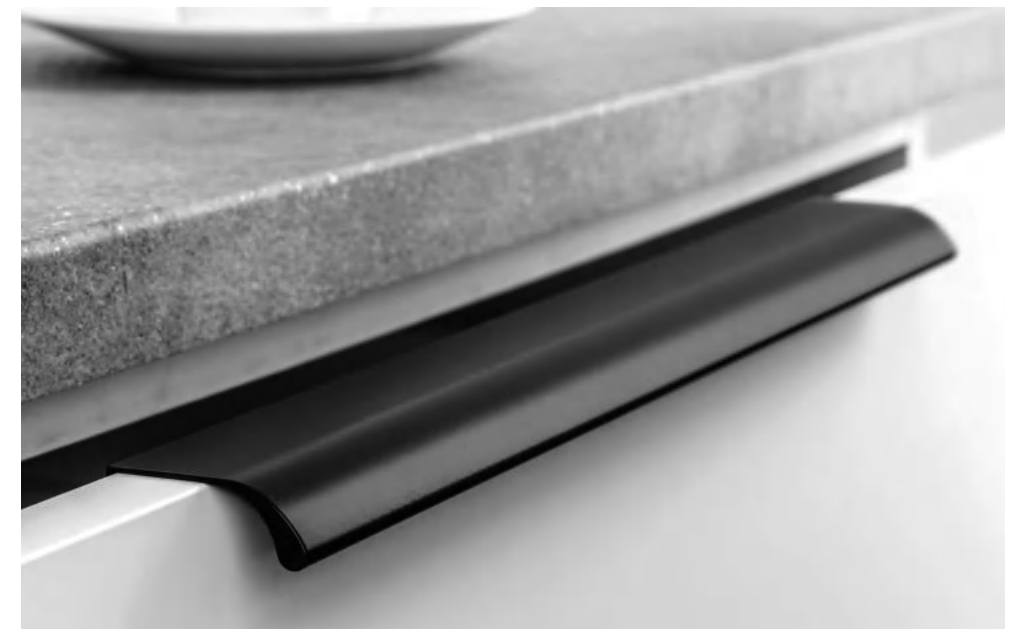
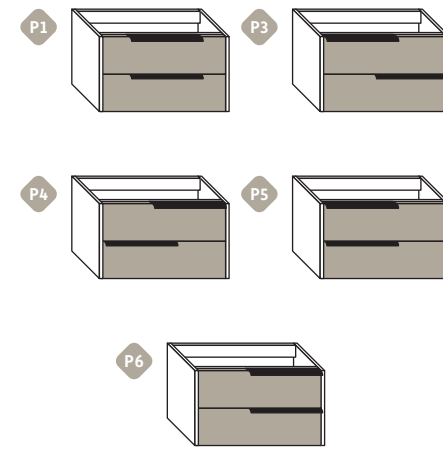

FANTASÍA	ARLUX	FENIX	LACA	MADERA
✓	✓	✓	✓	✓

• Medida tirador según medida frente. Ver criterio pág. 210.

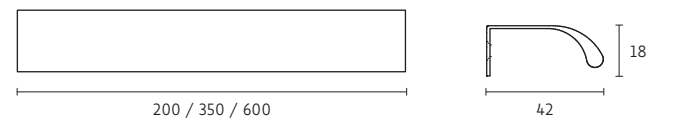

new standard

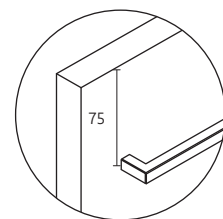

FANTASÍA	ARLUX	FENIX	LACA	MADERA
✓	✓	✓	✓	✓

• Medida tirador según medida frente. Ver criterio pág. 210.

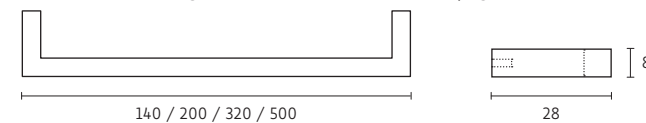

diana

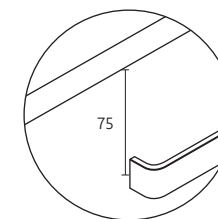

FANTASÍA	ARLUX	FENIX	LACA	MADERA
✓	✓	✓	✓	✓

• Medida tirador según medida frente. Ver criterio pág. 210.

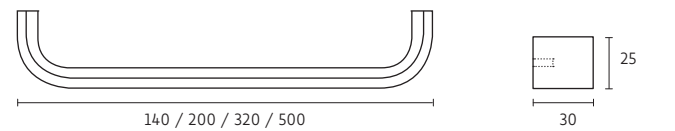

cristina LSM

LACA SELECT MATE (LSM)

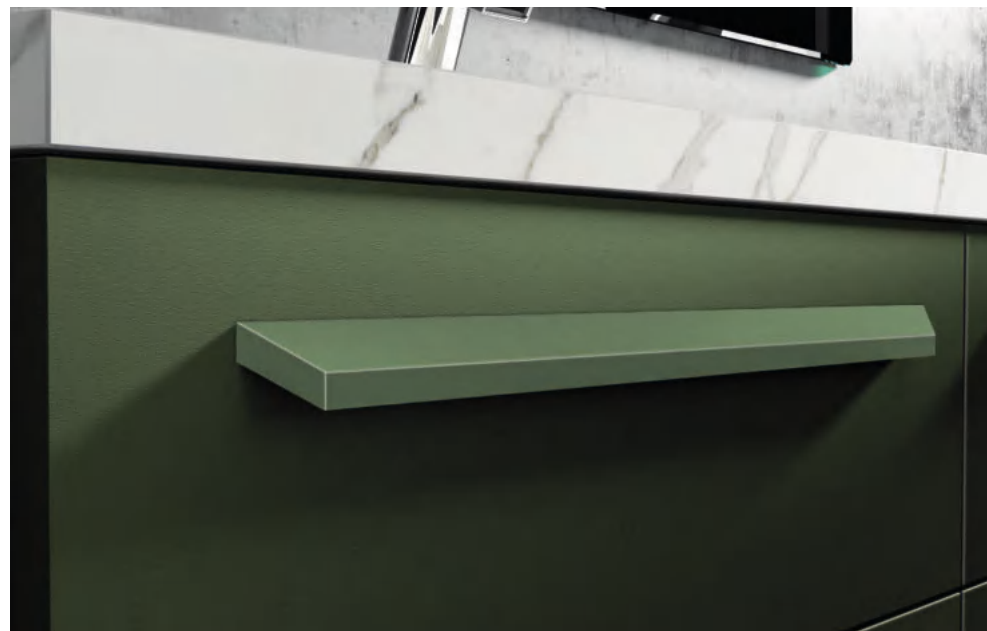

FANTASÍA	ARLUX	FENIX	LACA	MADERA
+55/und.	+55/und.	+55/und.	+55/und.	+55/und.

• Medida tirador según medida frente. Ver criterio pág. 210.

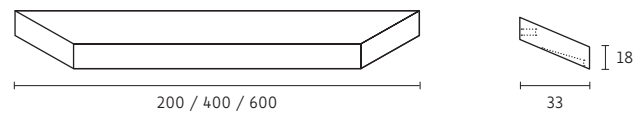

bea



NEGRO



PLATA

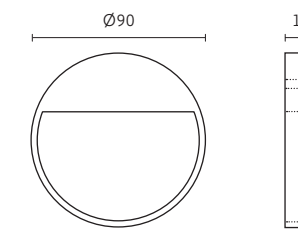

FANTASÍA	ARLUX	FENIX	LACA	MADERA
✓	✓	✓	✓	✓

• Opción 2º unidad/frente +50€

cristina madera

MADERAS

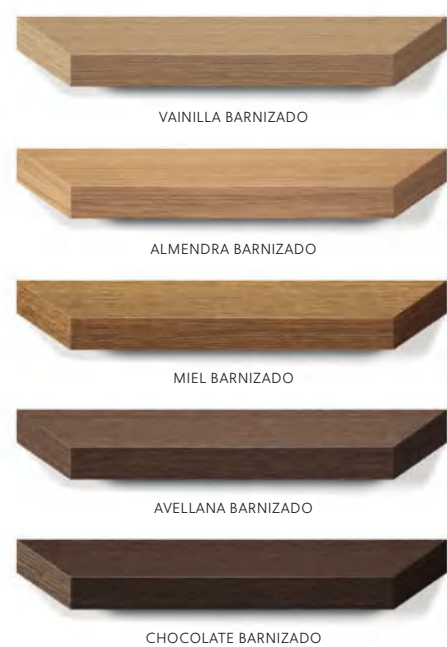

FANTASÍA	ARLUX	FENIX	LACA	MADERA
+45/und.	+45/und.	+45/und.	+45/und.	+45/und.

• Medida tirador según medida frente. Ver criterio pág. 210.

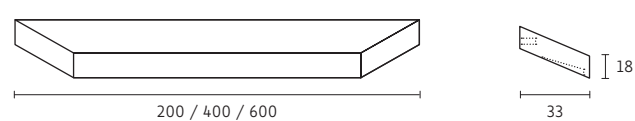

bruna



NEGRO/HAYA



NEGRO/BLANCO

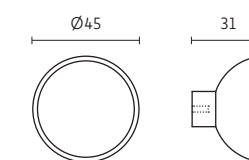

FANTASÍA	ARLUX	FENIX	LACA	MADERA
✓	✓	✓	✓	✓

• Opción 2º unidad/frente +50€



elsa



NEGRO

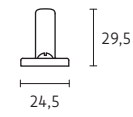
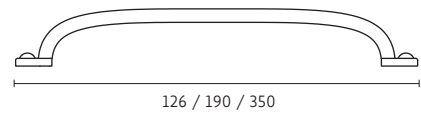

• Medida tirador según medida frente. Ver criterio pág. 210.

FANTASÍA	ARLUX	FENIX	LACA	MADERA
✓	✓	✓	✓	✓

carmen



NEGRO



CROMO

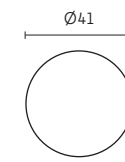

FANTASÍA	ARLUX	FENIX	LACA	MADERA
✓	✓	✓	✓	✓

• Opción 2º unidad/frente +50€

paola



NEGRO



PLATA VIEJA

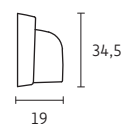
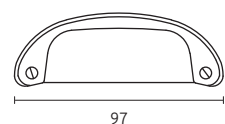

FANTASÍA	ARLUX	FENIX	LACA	MADERA
✓	✓	✓	✓	✓

• Opción 2º unidad/frente +50€

helen

PUERTA CORREDERA



NEGRO



CROMO

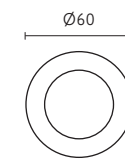

FANTASÍA	ARLUX	FENIX	LACA	MADERA
✓	✓	✓	✓	✓



02.



FONDO hasta 50 cm.
SIN INCREMENTO



LACA RAL
MATE/BRILLO +15%
METALIZADO +20%

BAJO LAVABOS

Cambio de distribución propuesta en ancho +60€.

Medidas fuera de tarifa incremento 10% cada 10 cm.
Ver rangos disponibles en ficha técnica (QR).

Cambio medida o posición tirador +30€/módulo.

Cremallera 3 posiciones no disponible con apertura Push.

Adaptación para lavabo otro fabricante,
consultar disponibilidad y precio.

Segundo mecanizado sifón (escote) +38€.

Altura mínima cajón para lavabos 24 cm.

Altura mínima cajón para lavabos bajo planos 32 cm.

Opción compactos de mano contraria sin incremento.

Cajones altura inferior 30 cm. se suministra sin tensores.

Información de guías de cajón ver página 06.

Enchufe interior instalado en cajón a 3 cm. del costado.



LED INFERIOR
+140€



ENCHUFE INTERIOR
+75€



CAJÓN INTERIOR
+125€



CREMALLERA 3 POSICIONES
+30€



ALTAVOZ INTEGRADO
+280€



CAJÓN SCALA
+25€/ud.



1 cajón (32)

Ref.:	Ancho hasta	Fondo hasta	Alto hasta	FANTASÍA	ARLUX	LACA SEL. MATE FENIX	MADERA
L26	60	50	32	295	360	435	471
	70	50	32	320	386	471	510
	80	50	32	348	412	494	535
	90	50	32	364	436	527	571
	100	50	32	379	451	561	607
	120	50	32	406	483	589	637



1 cajón (48)

Ref.:	Ancho hasta	Fondo hasta	Alto hasta	FANTASÍA	ARLUX	LACA SEL. MATE FENIX	MADERA
L06	60	50	48	325	400	509	550
	70	50	48	350	430	544	591
	80	50	48	370	463	565	600
	90	50	48	388	483	607	679
	100	50	48	404	498	646	685
	120	50	48	435	560	703	745



1 cajón/1 decorativo (32+24)

Ref.:	Ancho hasta	Fondo hasta	Alto hasta	FANTASÍA	ARLUX	LACA SEL. MATE FENIX	MADERA
L33	60	50	56	399	490	671	784
	70	50	56	418	514	722	843
	80	50	56	437	548	769	900
	90	50	56	455	576	823	963
	100	50	56	474	594	876	1023
	120	50	56	489	645	980	1144



· Disponible en estructuras Classic y Cuadro 2.



1 cajón/2 decorativos

Ref.:	Ancho hasta	Fondo hasta	Alto hasta	FANTASÍA	ARLUX	LACA SEL. MATE FENIX	MADERA
L40	100	50	48	477	643	1011	1113
	120	50	48	535	701	1106	1172

· Sólo para lavabos desplazados.

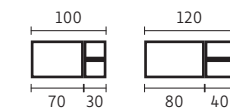

FICHAS TÉCNICAS



VERSIONES 1 CAJÓN + 1 CAJÓN

1+1 cajón asimétrico
LAVABO DESPLAZADO/CENTRADO

Ref.:	Ancho hasta	Fondo hasta	Alto hasta	FANTASÍA	ARLUX	LACA SEL. MATE FENIX	MADERA
L24	100	50	48	576	664	786	843
	120	50	48	598	723	835	893

• Ancho inferior a 100 cm. solo con lavabo desplazado.

1+1 cajón simétrico
LAVABO CENTRADO

Ref.:	Ancho hasta	Fondo hasta	Alto hasta	FANTASÍA	ARLUX	LACA SEL. MATE FENIX	MADERA
L25	80	50	48	573	598	800	861
	90	50	48	598	652	846	904
	100	50	48	617	694	884	951
	120	50	48	647	755	940	1009

• *Medida de hueco sifón 13 cm.

1+1 cajón simétrico
LAVABO DESPLAZADO

Ref.:	Ancho hasta	Fondo hasta	Alto hasta	FANTASÍA	ARLUX	LACA SEL. MATE FENIX	MADERA
L42	100	50	48	576	643	786	843
	120	50	48	598	700	835	893

1+1 cajón
LAVABO DOBLE

Ref.:	Ancho hasta	Fondo hasta	Alto hasta	FANTASÍA	ARLUX	LACA SEL. MATE FENIX	MADERA
L43	100	50	48	600	672	840	892
	120	50	48	631	729	886	951
	140	50	48	732	846	1027	1104

VERSIONES 2 CAJONES

2 cajones (24+24)

Ref.:	Ancho hasta	Fondo hasta	Alto hasta	FANTASÍA	ARLUX	LACA SEL. MATE FENIX	MADERA
L44	60	50	48	455	531	640	689
	70	50	48	476	556	673	729
	80	50	48	491	582	696	754
	90	50	48	525	616	750	814
	100	50	48	568	675	776	853
120	50	48	597	702	843	924	

2 cajones (24+32)

Ref.:	Ancho hasta	Fondo hasta	Alto hasta	FANTASÍA	ARLUX	LACA SEL. MATE FENIX	MADERA
L07	60	50	56	470	553	667	722
	70	50	56	490	581	702	759
	80	50	56	509	607	724	784
	90	50	56	541	643	781	845
	100	50	56	586	705	812	888
120	50	56	617	731	882	964	

2 cajones (24+40)

Ref.:	Ancho hasta	Fondo hasta	Alto hasta	FANTASÍA	ARLUX	LACA SEL. MATE FENIX	MADERA
L08	60	50	64	489	568	667	744
	70	50	64	510	602	723	804
	80	50	64	527	637	759	842
	90	50	64	562	668	799	886
	100	50	64	611	736	857	951
120	50	64	643	749	927	1027	

2 cajones (32+32)

Ref.:	Ancho hasta	Fondo hasta	Alto hasta	FANTASÍA	ARLUX	LACA SEL. MATE FENIX	MADERA
L09	60	50	64	488	595	707	770
	70	50	64	511	625	746	827
	80	50	64	542	652	786	873
	90	50	64	567	689	837	932
	100	50	64	609	714	886	985
120	50	64	633	763	948	1048	

2 cajones (44+44)

Ref.:	Ancho hasta	Fondo hasta	Alto hasta	FANTASÍA	ARLUX	LACA SEL. MATE FENIX	MADERA
L47	60	50	88	561	684	813	886
	70	50	88	588	719	858	951
	80	50	88	623	750	904	1004
	90	50	88	652	792	963	1072
	100	50	88	700	821	1019	1133
120	50	88	728	877	1090	1205	

• Incluye patas regulables de 1 cm o zócalo según indicaciones del cliente.



VERSIONES 4 CAJONES

4 cajones asimétrico
LAVABO DESPLAZADO/CENTRADO

Ref.:	Ancho hasta	Fondo hasta	Alto hasta	FANTASÍA	ARLUX	LACA SEL. MATE FENIX	MADERA
L12	100	50	64	811	945	1086	1180
	120	50	64	836	989	1156	1240

• Ancho inferior a 100 cm. solo con lavabo desplazado.

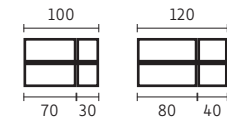

4 cajones simétrico
LAVABO CENTRADO

Ref.:	Ancho hasta	Fondo hasta	Alto hasta	FANTASÍA	ARLUX	LACA SEL. MATE FENIX	MADERA
L32	80	50	64	851	969	1089	1181
	90	50	64	876	989	1153	1233
	100	50	64	899	1024	1218	1304
	120	50	64	927	1060	1299	1379

• Medida de hueco sifón 13 cm.



4 cajones simétrico
LAVABO DESPLAZADO

Ref.:	Ancho hasta	Fondo hasta	Alto hasta	FANTASÍA	ARLUX	LACA SEL. MATE FENIX	MADERA
L45	100	50	64	811	945	1086	1202
	120	50	64	836	989	1156	1238



4 cajones
LAVABO DOBLE

Ref.:	Ancho hasta	Fondo hasta	Alto hasta	FANTASÍA	ARLUX	LACA SEL. MATE FENIX	MADERA
L46	100	50	64	872	1007	1154	1276
	120	50	64	898	1052	1223	1354
	140	50	64	1042	1220	1420	1570



2 cajones / 2 decorativos

Ref.:	Ancho hasta	Fondo hasta	Alto hasta	FANTASÍA	ARLUX	LACA SEL. MATE FENIX	MADERA
L41	90	50	64	614	781	1087	1237
	100	50	64	657	809	1176	1315
	120	50	64	736	883	1277	1418

• Sólo para lavabos desplazados.

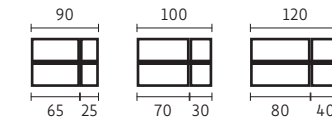

2 cajones / 1 decorativo superior

Ref.:	Ancho hasta	Fondo hasta	Alto hasta	FANTASÍA	ARLUX	LACA SEL. MATE FENIX	MADERA
L36	90	50	64	614	774	923	1079
	100	50	64	642	809	985	1153
	120	50	64	677	865	1041	1220

• Sólo para lavabos desplazados.

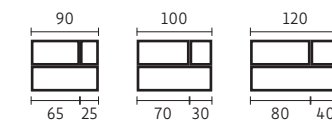

2 cajones / 1 decorativo inferior

Ref.:	Ancho hasta	Fondo hasta	Alto hasta	FANTASÍA	ARLUX	LACA SEL. MATE FENIX	MADERA
L34	80	50	64	573	721	979	1113
	90	50	64	595	756	1041	1184
	100	50	64	614	800	1090	1253
	120	50	64	635	857	1156	1315

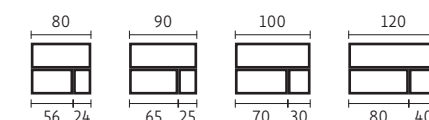

4 cajones cruzados

Ref.:	Ancho hasta	Fondo hasta	Alto hasta	FANTASÍA	ARLUX	LACA SEL. MATE FENIX	MADERA
L38	100	50	64	863	954	1122	1213
	120	50	64	893	1039	1203	1302

• Ancho inferior a 100 cm. solo con lavabo desplazado.

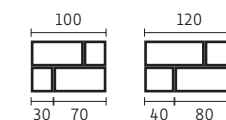

2 cajones superiores / 1 cajón inferior

Ref.:	Ancho hasta	Fondo hasta	Alto hasta	FANTASÍA	ARLUX	LACA SEL. MATE FENIX	MADERA
L30	100	50	64	748	865	980	1088
	120	50	64	770	904	1086	1144

• Ancho inferior a 100 cm. solo con lavabo desplazado.

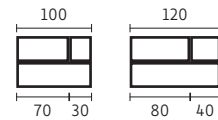

3 cajones

Ref.:	Ancho hasta	Fondo hasta	Alto hasta	FANTASÍA	ARLUX	LACA SEL. MATE FENIX	MADERA
L10	60	50	78	615	728	853	970
	70	50	78	639	758	879	996
	80	50	78	685	787	924	1035
	90	50	78	701	828	1006	1126
	100	50	78	738	862	1030	1154
	120	50	78	764	904	1122	1257



1 cajón superior / 2 cajones inferiores

Ref.:	Ancho hasta	Fondo hasta	Alto hasta	FANTASÍA	ARLUX	LACA SEL. MATE FENIX	MADERA
L35	80	50	64	689	814	924	1025
	90	50	64	726	834	972	1081
	100	50	64	748	865	980	1088
	120	50	64	770	904	1086	1205

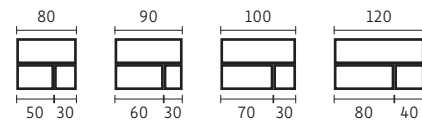

1 puerta

Ref.:	Ancho hasta	Fondo hasta	Alto hasta	FANTASÍA	ARLUX	LACA SEL. MATE FENIX	MADERA
L27	50	50	64	255	322	484	542
	60	50	64	281	355	533	596

• Indicar mano.

piccolo 1 puerta

Ref.:	Ancho hasta	Fondo hasta	Alto hasta	FANTASÍA	ARLUX	LACA SEL. MATE FENIX	MADERA
L28	36	20	64	236	298	431	479



1+2 cajones superiores / 1 cajón inferior LAVABO DESPLAZADO

Ref.:	Ancho hasta	Fondo hasta	Alto hasta	FANTASÍA	ARLUX	LACA SEL. MATE FENIX	MADERA
L37	90	50	64	815	925	1048	1097
	100	50	64	837	958	1090	1144
	120	50	64	862	988	1181	1221

• Sólo para lavabo desplazado, cajón superior siempre con escote.
• Mueble siempre P1 y cajones pequeños P2.

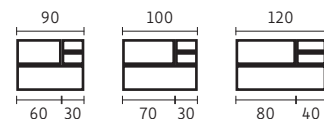

2 puertas

Ref.:	Ancho hasta	Fondo hasta	Alto hasta	FANTASÍA	ARLUX	LACA SEL. MATE FENIX	MADERA
L01	50	50	64	288	385	487	540
	60	50	64	303	412	515	591
	70	50	64	332	444	543	622
	80	50	64	349	453	571	641
L48	50	50	88	343	458	580	643
	60	50	88	361	490	613	703
	70	50	88	395	528	646	740
	80	50	88	415	539	679	763

• Ref L48 Incluye patas regulables de 1 cm o zócalo según indicaciones del cliente.



1 cajón / 2 cajones

Ref.:	Ancho hasta	Fondo hasta	Alto hasta	FANTASÍA	ARLUX	LACA SEL. MATE FENIX	MADERA
L31	100	50	48	663	748	930	1005
	120	50	48	723	804	1013	1097

• Ancho inferior a 100 cm. solo con lavabo desplazado.

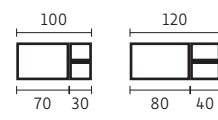

3 puertas

Ref.:	Ancho hasta	Fondo hasta	Alto hasta	FANTASÍA	ARLUX	LACA SEL. MATE FENIX	MADERA
L21	80	50	64	429	535	666	727
	90	50	64	456	562	692	741
	100	50	64	491	583	717	769
	120	50	64	520	619	781	840
L49	80	50	88	511	637	793	865
	90	50	88	543	669	823	882
	100	50	88	584	694	853	915
	120	50	88	619	737	929	1000

• Ref L49 Incluye patas regulables de 1 cm o zócalo según indicaciones del cliente.



2 puertas / 1 cajón

Ref.:	Ancho hasta	Fondo hasta	Alto hasta	FANTASÍA	ARLUX	LACA SEL. MATE FENIX	MADERA
L02	60	50	64	448	542	664	741
	70	50	64	477	584	718	801
	80	50	64	491	598	749	827

+140€
+75€
+30€

3 cajones / 1 puerta

Ref.:	Ancho hasta	Fondo hasta	Alto hasta	FANTASÍA	ARLUX	LACA SEL. MATE FENIX	MADERA
L22	80	50	78	726	866	1037	1152
	90	50	78	765	895	1111	1234
	100	50	78	783	927	1168	1297
	120	50	78	853	993	1257	1396

+140€
+75€
+30€
+280€

Opción P2 con puerta Push.

2 puertas / 2 cajones

Ref.:	Ancho hasta	Fondo hasta	Alto hasta	FANTASÍA	ARLUX	LACA SEL. MATE FENIX	MADERA
L11	90	50	64	615	741	876	972
	100	50	64	637	770	915	1015
	120	50	64	677	812	986	1095

Ancho inferior a 100 cm. solo con lavabo desplazado.

+140€
+75€
+30€
+280€

Opción P2 con puerta Push.

1 puerta / 2 cajones / 1 puerta

Ref.:	Ancho hasta	Fondo hasta	Alto hasta	FANTASÍA	ARLUX	LACA SEL. MATE FENIX	MADERA
L18	100	50	64	708	838	985	1094
	120	50	64	769	920	1109	1232

+75€
+30€
+280€

Opción P2 con puerta Push.

2 puertas / 3 cajones

Ref.:	Ancho hasta	Fondo hasta	Alto hasta	FANTASÍA	ARLUX	LACA SEL. MATE FENIX	MADERA
L17	90	50	78	716	865	1011	1160
	100	50	78	739	893	1056	1211
	120	50	78	770	945	1140	1308

Ancho inferior a 100 cm. solo con lavabo desplazado.

+140€
+75€
+30€
+280€

Opción P2 con puerta Push.

2 puertas correderas

Ref.:	Ancho hasta	Fondo hasta	Alto hasta	FANTASÍA	ARLUX	LACA SEL. MATE FENIX	MADERA
L39	60	50	64	577	739	988	1094
	70	50	64	606	776	1038	1150
	80	50	64	637	816	1086	1205

Siempre estructura Cuadro.
Sólo disponible con tirador Helen.
No apto para modular.

+30€

2 cajones / 1 puerta

Ref.:	Ancho hasta	Fondo hasta	Alto hasta	FANTASÍA	ARLUX	LACA SEL. MATE FENIX	MADERA
L13	80	50	64	589	701	833	927
	90	50	64	615	728	878	976
	100	50	64	636	755	913	1013
	120	50	64	674	811	980	1090

+140€
+75€
+30€
+280€

Opción P2 con puerta Push.

rinconero 1 puerta

Ref.:	Ancho hasta	Fondo hasta	Alto hasta	FANTASÍA	ARLUX	LACA SEL. MATE FENIX	MADERA
L29	60/60	32s/32s	64	369	439	543	606

Indicar mano.
No válido con tirador Gola ni Recto.



03.

COQUETAS MODULARES

50
FONDO hasta 50 cm. SIN INCREMENTO

LACA RAL MATE/BRILLO +15% METALIZADO +20%

Cremallera 3 posiciones no disponible con apertura Push.

Altura mínima cajón 16 cm. (en el caso de sistema de apertura con calle mínimo 19 cm.).

Medidas fuera de tarifa incremento 10% cada 10 cm. Ver rangos disponibles en ficha técnica (QR).

Cambio medida o posición tirador +30€/módulo. Consultar disponibilidad en ficha técnica.

Los frentes de coquetas, están representados en acabado Wood Legno, decorativos y laterales en RAL 7015, acabado de techos no incluidos (en blanco).

Las coquetas necesitan encimera (techo no está acabado).

Fondo mínimo de cajón 32,5 cm.

Enchufe interior instalado en cajón a 3 cm. del costado.



LED INTERIOR +140€

LED INFERIOR +140€

ENCHUFE INTERIOR +75€

CAJÓN INTERIOR +125€

CREMALLERA 3 POSICIONES +30€

1 puerta



Ref.:	Ancho hasta	Fondo hasta	Alto hasta	FANTASÍA	ARLUX	LACA SEL. MATE FENIX	MADERA
C01	30	50	64	239	260	365	397
	35	50	64	254	282	389	424
	40	50	64	264	293	413	452
	45	50	64	271	307	437	487
C43	30	50	88	284	309	434	472
	35	50	88	302	336	463	505
	40	50	88	314	349	491	538
	45	50	88	322	365	520	580

• Ref C43 incluye patas regulables de 1 cm o zócalo según indicaciones del cliente.
• Indicar mano.



2 puertas



Ref.:	Ancho hasta	Fondo hasta	Alto hasta	FANTASÍA	ARLUX	LACA SEL. MATE FENIX	MADERA
C02	50	50	64	308	350	436	479
	60	50	64	320	370	483	533
	70	50	64	343	390	527	581
	80	50	64	362	415	568	626
C44	50	50	88	367	417	519	570
	60	50	88	381	440	575	634
	70	50	88	408	464	627	691
	80	50	88	431	494	676	745

• Ref C44 incluye patas regulables de 1 cm o zócalo según indicaciones del cliente.



1 cajón / 1 puerta



Ref.:	Ancho hasta	Fondo hasta	Alto hasta	FANTASÍA	ARLUX	LACA SEL. MATE FENIX	MADERA
C03	35	50	64	352	376	473	512
	40	50	64	363	390	500	529

• Indicar mano.



1 cajón



Ref.:	Ancho hasta	Fondo hasta	Alto hasta	FANTASÍA	ARLUX	LACA SEL. MATE FENIX	MADERA
C10	35	50	32	269	293	347	376
	50	50	32	281	307	367	397
	70	50	32	309	343	421	465
	90	50	32	342	379	482	533
	110	50	32	356	411	535	592



Más información e instrucciones de montaje.

1 cajón

-  +140€
-  +75€
-  +125€

Ref.:	Ancho hasta	Fondo hasta	Alto hasta	FANTASÍA	ARLUX	LACA SEL. MATE FENIX	MADERA
C23	35	50	48	295	327	382	413
	50	50	48	320	359	437	482
	70	50	48	348	387	503	555
	90	50	48	372	428	578	638
	110	50	48	385	453	617	680



cubre lavadora

Ref.:	Ancho hasta	Fondo hasta	Alto hasta	FANTASÍA	ARLUX	LACA SEL. MATE FENIX	MADERA
C34	70→80	65→70	88	437	516	756	923
C41	Modelo desmontado			437	516	756	923

- No válido para sistemas de apertura con calle.
- Zócalo desmontable.



2 cajones

-  +140€
-  +75€
-  +125€

Ref.:	Ancho hasta	Fondo hasta	Alto hasta	FANTASÍA	ARLUX	LACA SEL. MATE FENIX	MADERA
C05	35	50	64	415	441	545	585
	50	50	64	463	503	649	710
	70	50	64	511	565	753	837
C42	90	50	64	559	625	826	926
	35	50	88	494	525	649	696
	50	50	88	551	599	772	845
	70	50	88	608	672	896	996
	90	50	88	665	744	983	1102

- Ref C42 incluye patas regulables de 1 cm o zócalo según indicaciones del cliente.



cubo

Ref.:	Ancho hasta	Fondo hasta	Alto hasta	FANTASÍA	ARLUX	LACA SEL. MATE FENIX	MADERA
C28	40→50	35→50	50→64	385	426	543	586

- Para uñeros altura mínima 50 cm.



3 cajones

-  +140€
-  +75€

Ref.:	Ancho hasta	Fondo hasta	Alto hasta	FANTASÍA	ARLUX	LACA SEL. MATE FENIX	MADERA
C06	35	50	78	514	570	682	726
	50	50	78	561	619	768	848
	70	50	78	630	695	902	995
	90	50	78	688	769	1037	1145



tolva metálica

Ref.:	Ancho hasta	Fondo hasta	Alto hasta	FANTASÍA	ARLUX	LACA SEL. MATE FENIX	MADERA
C27	35	35→50	60→64	352	383	461	513
	45	35→50	60→64	384	423	501	540

- Sistema de apertura con calle altura mín. 64 cm.
- Medidas tolva metálica 27 x 25 cm. y 37 x 25 cm. (ancho x fondo).



4 cajones

-  +140€
-  +75€

Ref.:	Ancho hasta	Fondo hasta	Alto hasta	FANTASÍA	ARLUX	LACA SEL. MATE FENIX	MADERA
C11	35	50	64→78	615	657	782	834
	50	50	64→78	676	733	887	967
	70	50	64→78	747	809	1021	1114
	90	50	64→78	807	883	1156	1264

- Altura mínima sin calle 64 cm.
- Altura mínima con calle 76 cm.



tolva cajón

Ref.:	Ancho hasta	Fondo hasta	Alto hasta	FANTASÍA	ARLUX	LACA SEL. MATE FENIX	MADERA
C08	35	50	64	366	387	479	512
	50	50	64	385	435	547	586

- Opción bolsa de tela a medida +130€.
- No apto para cajón SCALA.



puertas correderas



Ref.:	Ancho hasta	Fondo hasta	Alto hasta	FANTASÍA	ARLUX	LACA SEL. MATE FENIX	MADERA
C09	60	50	64	566	774	1062	1202
	70	50	64	593	820	1114	1257
	80	50	64	615	860	1172	1324

- Siempre estructura Cuadro 2.
- Sólo disponible con tirador Helen.
- No válido para modular.



chaflán 1 puerta

Ref.:	Ancho hasta	Fondo hasta	Alto hasta	FANTASÍA	ARLUX	LACA SEL. MATE FENIX	MADERA
C26	30	50	64	282	334	424	487
	40	50	64	302	388	468	539

- Solo válido para estructura Classic.
- Importante consultar opciones de fondos en ficha técnica.
- Si va contra pared, necesario añadir regleta vertical.

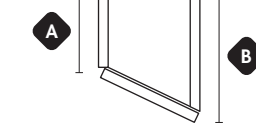

tocador suspendido / sobre mueble



TOCADOR SOBRE MUEBLE C390

Ref.:	Ancho hasta	Fondo hasta	Alto hasta	FANTASÍA	ARLUX	LACA SEL. MATE FENIX	MADERA
C391	40	40→50	16→24	277	327	403	445
	50	40→50	16→24	299	345	420	463
	60	40→50	16→24	334	386	472	521
	70	40→50	16→24	372	429	531	586

- Indicar ubicación; suspendido (C391) o sobre mueble (C390).
- Interior Marengo.
- La puerta vuela 1 cm. más que la estructura Classic.
- No válido para modular.



decorativo abierto chaflán

Ref.:	Ancho hasta	Fondo hasta	Alto hasta	FANTASÍA	ARLUX	LACA SEL. MATE FENIX	MADERA
C33	30	50	64	230	308	515	601
	40	50	64	277	346	603	704

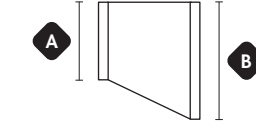

taburete

Ref.:	Ancho hasta	Fondo hasta	Alto hasta	FANTASÍA	ARLUX	LACA SEL. MATE FENIX	MADERA
C31	40	40	50	366	453	607	709

- Interior Marengo.
- La altura incluye el asiento tapizado ±2 cm.
- Asiento tapizado en polipiel negro.



1 cajón / decorativo



Ref.:	Ancho hasta	Fondo hasta	Alto hasta	FANTASÍA	ARLUX	LACA SEL. MATE FENIX	MADERA
C25	35	50	64	311	428	524	591
	40	50	64	334	470	574	647
	50	50	64	355	513	623	704
	60	50	64	377	555	646	728

- Hueco a ras de armazón.



toallero

Ref.:	Ancho hasta	Fondo hasta	Alto hasta	FANTASÍA	ARLUX	LACA SEL. MATE FENIX	MADERA
C12	21→30	32→50	64	234	325	440	513

- De no indicar lo contrario se suministra a ras de frente.
- Incluye herraje toallero.
- Segundo herraje toallero +55€.



decorativo / 1 cajón



Ref.:	Ancho hasta	Fondo hasta	Alto hasta	FANTASÍA	ARLUX	LACA SEL. MATE FENIX	MADERA
C24	35	50	64	311	428	524	591
	40	50	64	334	470	574	647
	50	50	64	355	513	623	704
	60	50	64	377	555	646	728

- Hueco a ras de armazón.



decorativo abierto



+140€

Ref.:	Ancho hasta	Fondo hasta	Alto hasta	FANTASÍA	ARLUX	LACA SEL. MATE FENIX	MADERA
C13	40	50	32	161	215	319	383
	60	50	32	175	257	395	446
	80	50	32	203	303	445	486

- De no indicar lo contrario se suministra a ras de frente.
- Ancho y altura mínima 21 cm.



decorativo abierto lateral

Ref.:	Ancho hasta	Fondo hasta	Alto hasta	FANTASÍA	ARLUX	LACA SEL. MATE FENIX	MADERA
C29	15	50	64	169	248	351	410
	25	50	64	185	294	427	498

- Se suministra sin colgadores.



decorativo abierto 2 caras

Ref.:	Ancho hasta	Fondo hasta	Alto hasta	FANTASÍA	ARLUX	LACA SEL. MATE FENIX	MADERA
C45	40	50	32	151	202	300	360
	60	50	32	165	242	371	419

- De no indicar lo contrario se suministra a ras de armazón.
- Altura mínima 21 cm.
- Sistema de regulación superior visto.



decorativo abierto 4 huecos

Ref.:	Ancho hasta	Fondo hasta	Alto hasta	FANTASÍA	ARLUX	LACA SEL. MATE FENIX	MADERA
C40	40	50	64	246	340	696	770
	60	50	64	285	377	760	857
	80	50	64	320	492	873	1052

- De no indicar lo contrario se suministra a ras de frente.



decorativo abierto doble

Ref.:	Ancho hasta	Fondo hasta	Alto hasta	FANTASÍA	ARLUX	LACA SEL. MATE FENIX	MADERA
C14	40	50	64	196	268	475	538
	60	50	64	221	311	530	593

- De no indicar lo contrario se suministra a ras de frente.
- Ancho mínimo 21 cm.



decorativo / 1 puerta corredera

Ref.:	Ancho hasta	Fondo hasta	Alto hasta	FANTASÍA	ARLUX	LACA SEL. MATE FENIX	MADERA
C32	60	50	64	411	645	846	987
	80	50	64	456	722	938	1095

- Siempre estructura Cuadro 2.
- Sólo disponible con tirador Helen.



decorativo abierto 3 huecos



+140€

Ref.:	Ancho hasta	Fondo hasta	Alto hasta	FANTASÍA	ARLUX	LACA SEL. MATE FENIX	MADERA
C46	90	50	32	235	322	570	646
	110	50	32	265	373	636	712

- De no indicar lo contrario se suministra a ras de frente.
- Altura mínima 21 cm.
- Opción iluminación interior



decorativo abierto bañera

Ref.:	Ancho hasta	Fondo hasta	Alto hasta	Huecos	FANTASÍA	ARLUX	LACAS.MATE FENIX	MADERA
C41	100	25	58,8	4	320	568	861	1073
	200	25	58,8	6	422	674	1057	1205
	220	25	58,8	6	506	808	1269	1447

- Se suministra con zócalo modular.



COQUETAS ALTAS (SEMI COLUMNAS)

1 puerta

Ref.:	Ancho hasta	Fondo hasta	Alto hasta	FANTASÍA	ARLUX	LACA SEL. MATE FENIX	MADERA
M56	30	35	85	289	405	546	636
	40	35	85	313	439	604	706
M17	30	50	115	336	498	639	748
	40	50	115	364	544	710	829

- Indicar mano.
- Tapa incluida.

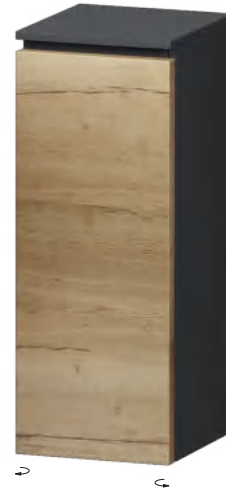

4 cajones

Ref.:	Ancho hasta	Fondo hasta	Alto hasta	FANTASÍA	ARLUX	LACA SEL. MATE FENIX	MADERA
M66	35	33→35	85	658	766	818	923
	45	33→35	85	687	808	875	990
M67	35	35→50	115	753	914	1040	1178
	45	35→50	115	790	966	1118	1270

- Tapa incluida.



2 cajones / 1 puerta

Ref.:	Ancho hasta	Fondo hasta	Alto hasta	FANTASÍA	ARLUX	LACA SEL. MATE FENIX	MADERA
M57	35	33→35	85	500	617	748	875
	45	33→35	85	532	663	816	955
M19	35	35→50	115	544	705	823	960
	45	35→50	115	580	756	900	1052

- Indicar mano.
- Tapa incluida.

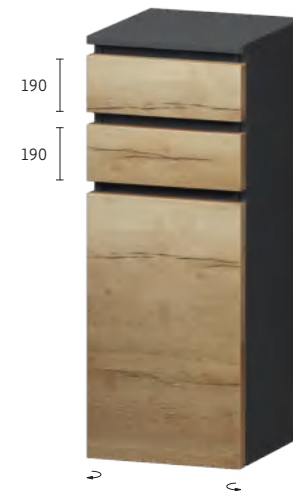

5 cajones

Ref.:	Ancho hasta	Fondo hasta	Alto hasta	FANTASÍA	ARLUX	LACA SEL. MATE FENIX	MADERA
M62	35	33→35	97	755	863	1025	1143
	45	33→35	97	784	905	1089	1218
M63	35	35→50	115	795	944	1149	1287
	45	35→50	115	828	991	1227	1379

- Tapa incluida.



tocador / 1 cajón / 1 puerta

Ref.:	Ancho hasta	Fondo hasta	Alto hasta	FANTASÍA	ARLUX	LACA SEL. MATE FENIX	MADERA
M58	40	35	85	601	741	837	980
	50	35	85	638	795	914	1069

- Indicar mano.
- Ancho mínimo 35 cm.
- Espejo interior Ø25 cm.



1 cajón / tolva

Ref.:	Ancho hasta	Fondo hasta	Alto hasta	FANTASÍA	ARLUX	LACA SEL. MATE FENIX	MADERA
M64	35	33→35	85	508	531	609	641
	45	33→35	85	539	594	677	715
M65	35	35→50	100	622	650	762	802
	45	35→50	100	646	713	848	896

- Tapa incluida.
- No disponible con cajón Scala.
- Opción bolsa de tela +130€.



TERMINACIONES

costado suelto 2 cm.

Ref.:	Alto hasta	Fondo hasta	FANTASÍA	ARLUX	LACA SEL. MATE FENIX	MADERA
F30	32	50	56	83	112	124
	64	50	84	114	142	162
	90	50	91	128	189	212

- La colocación del mismo aumenta el mueble en ancho 2 cm.
- Se suministra sin sistema de colocación.

traseira para mueble isla

Ref.:	Ancho hasta	Alto hasta	FANTASÍA	ARLUX	LACA SEL. MATE FENIX	MADERA
F34	80	88	158	203	296	338
	120	88	219	288	417	479
	160	88	293	386	552	635

- Se suministra preparado con sistema de colocación. Para composiciones modulares consultar viabilidad.
- La colocación del mismo aumenta el mueble en fondo 2 cm



suplemento techo visto

Ref.:	Ancho hasta	Fondo hasta	FANTASÍA	ARLUX	LACA SEL. MATE FENIX	MADERA
S15	32	50	15	22	41	46
	64	50	20	29	79	94
	90	50	24	49	111	133

- Siempre entre costados.



regleta lateral veta vertical

Ref.:	Alto hasta	Ancho	FANTASÍA	ARLUX	LACA SEL. MATE FENIX	MADERA
F36	76	2→12	38	50	92	95
	140	2→12	62	80	156	159
	201	2→12	89	113	204	218

- Se suministra con 3 cantos terminados (2 cortos y 1 largo).
- 4 cantos terminados +50€ (ancho mínimo de 8 cm.).



regleta lateral veta horizontal

Ref.:	Alto hasta	Ancho	FANTASÍA	ARLUX	LACA SEL. MATE FENIX	MADERA
F16	76	2→12	51	63	86	110
	120	2→12	70	88	146	173

- Se suministra con 3 cantos terminados (2 cortos y 1 largo).
- 4 cantos terminados +50€ (ancho mínimo de 8 cm.).



SISTEMAS PARA MUEBLES HASTA EL SUELO

pata oculta -frentes a suelo

- Para muebles hasta el suelo.
- Se suministra instalado, 4 patas regulables de 1 cm.
- Precio incluido con el incremento del mueble a suelo.



zócalo compacto

Ancho hasta	Alto
120	6→15

- Laterales de mueble hasta el suelo.
- Se suministra instalado.
- De no indicar lo contrario altura del zócalo 10 cm.
- Precio incluido con el incremento del mueble a suelo.



zócalo modular

Alto
8→15

- De no indicar lo contrario altura zócalo 10 cm.
- Se suministra suelto con enganche a las patas interiores regulables.
- Precio incluido con el incremento del mueble a suelo.



peana bastidor

Ref.:	Ancho hasta	Fondo hasta	Alto mínimo	FANTASÍA	ARLUX	LACA SEL. MATE FENIX	MADERA
F27	60	50	8	113	127	161	188
	80	50	8	138	153	183	215
	100	50	8	147	168	217	253
	120	50	8	153	184	237	278

- De no indicar lo contrario; ancho -2 cm. y fondo -6 cm.



04.^A



FONDO
hasta 50 cm.
SIN INCREMENTO

REPISAS Y ENCIMERAS

Calado y orificio grifo para lavabo de otros fabricantes +90€
(obligatorio adjuntar ficha técnica).

Consultar otras medidas, precio y disponibilidad.

Soportes no incluidos en encimeras.

Las encimeras están representadas en acabado
Fantasía Roble Andes y RAL 7015.



**RESISTENTE
HUMEDAD
NO MOJAR**



FICHAS TÉCNICAS



REPISAS

repisa grosor 2 cm.

Ref.:	Ancho hasta	Fondo	Grosor	FANTASÍA	ARLUX	LACA SEL. MATE FENIX	MADERA
F12	40	10→20	2	84	95	113	119
	60	10→20	2	90	107	135	143
	80	10→20	2	108	124	153	161
	100	10→20	2	120	151	170	194
	120	10→20	2	150	162	185	215

• Incluye soporte oculto.



repisa grosor 3 cm.

Ref.:	Ancho hasta	Fondo	Grosor	FANTASÍA	ARLUX	LACA SEL. MATE	MADERA
F13	40	10→20	3	-	-	138	-
	60	10→20	3	-	-	156	-
	80	10→20	3	-	-	186	-
	100	10→20	3	-	-	218	-
	120	10→20	3	-	-	233	-

• Incluye soporte oculto.



repisa grosor 5 cm.

Ref.:	Ancho hasta	Fondo	Grosor	FANTASÍA	ARLUX	LACA SEL. MATE	MADERA
F15	40	10→20	5	-	-	172	183
	60	10→20	5	-	-	186	219
	80	10→20	5	-	-	220	242
	100	10→20	5	-	-	253	295
	120	10→20	5	-	-	276	321

• Incluye soporte oculto.



repisa barandilla

Ref.:	Ancho hasta	Fondo	Alto	FANTASÍA	ARLUX	LACA SEL. MATE FENIX	MADERA
F17	40	12→20	8	141	159	187	197
	60	12→20	8	150	180	224	236
	80	12→20	8	181	208	253	269
	100	12→20	8	201	251	283	321
	120	12→20	8	250	271	307	356

• Incluye soporte oculto.



Más información e instrucciones de montaje.

ENCIMERAS

encimera grosor 2 cm.

Ref.:	Ancho hasta	Fondo hasta	Grosor	FANTASÍA	ARLUX	LACA SEL. MATE FENIX	MADERA
F22	41	51	2	83	101	146	171
	61	51	2	89	115	167	191
	81	51	2	105	135	197	225
	101	51	2	122	160	230	265
	121	51	2	146	192	278	319
	151	51	2	183	241	345	397
	181	51	2	220	289	414	476
	201	51	2	244	321	462	529



ENCIMERAS

encimera grosor 2 + faldón 6→15 cm.

Ref.:	Ancho hasta	Fondo hasta	Grosor	FANTASÍA	ARLUX	LACA SEL. MATE FENIX	MADERA
F24	61	51	8→17	143	190	289	338
	81	51	8→17	174	230	351	410
	101	51	8→17	205	271	414	482
	121	51	8→17	246	325	497	579
	151	51	8→17	308	406	621	722
	181	51	8→17	370	486	744	866
	201	51	8→17	411	541	827	963



• Permiten New Soporte Oculto, ver pág. 66.

encimera grosor 3 cm.

Ref.:	Ancho hasta	Fondo hasta	Grosor	FANTASÍA	ARLUX	LACA SEL. MATE	MADERA
F23	41	51	3	-	-	162	-
	61	51	3	-	-	185	-
	81	51	3	-	-	219	-
	101	51	3	-	-	256	-
	121	51	3	-	-	308	-
	151	51	3	-	-	383	-
	181	51	3	-	-	461	-
	201	51	3	-	-	513	-

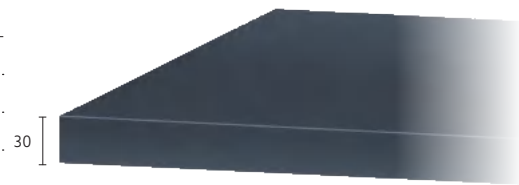

suplemento cajón integrado en encimera (izq. o dch.)
PARA ENCIMERA F24 GROSOR 2

Ref.:	Ancho hasta	Fondo	Alto	PVP
S20	40	33→51	17→24	195
	60	33→51	17→24	225
	80	33→51	17→24	295



- Indicar posicionamiento del cajón (izq. o dch.).
- Apertura de cajón inferior.
- No incluye soportes.
- No es posible ubicar el lavabo sobre el cajón.
- Ancho mínimo de encimera 60 cm.

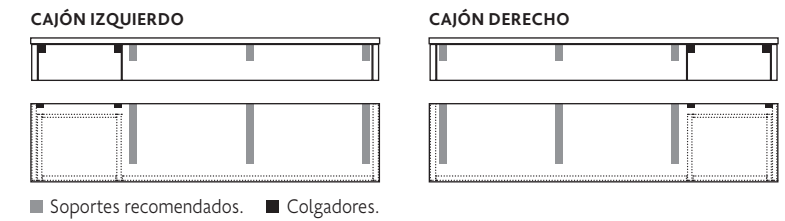

encimera grosor 5 cm.

Ref.:	Ancho hasta	Fondo hasta	Grosor	FANTASÍA	ARLUX	LACA SEL. MATE	MADERA
F25	61	51	5	-	-	209	232
	81	51	5	-	-	253	290
	101	51	5	-	-	335	386
	121	51	5	-	-	381	438
	151	51	5	-	-	467	537
	181	51	5	-	-	565	650
	201	51	5	-	-	680	780

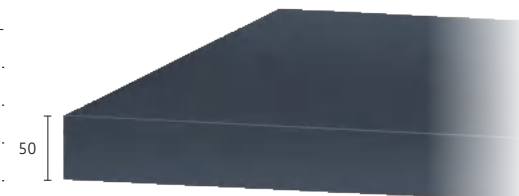

encimera faldón inglete

Ref.:	Ancho hasta	Fondo hasta	Grosor	FANTASÍA	ARLUX	LACA SEL. MATE	MADERA
F28	61	51	8→15	-	-	389	452
	81	51	8→15	-	-	468	541
	101	51	8→15	-	-	523	600
	121	51	8→15	-	-	604	696
	151	51	8→15	-	-	720	826
	181	51	8→15	-	-	826	951
	201	51	8→15	-	-	906	1041

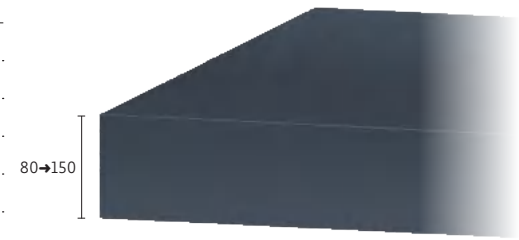

• Permiten New Soporte Oculto, ver pág. 66.



04. B



FONDO hasta 50 cm.
SIN INCREMENTO



LACA RAL
MATE/BRILLO +15%
METALIZADO +20%

BANCADAS

Encimera incluida en el precio.

Medida total corresponde a la encimera, se suministra con vuelo delantero y laterales de 0,3 cm.

Altura mínima bancada 18 cm. (21 cm. con calle).

Opción de encimeras sin vuelo lateral, indicar mano.

Cambio medida o posición tirador +30€/módulo.

En caso de no sujetar a la pared es necesario el uso de contrapeso antivuelco para anchura mayor a 40 cm.

(ver precios en pág. 67):

Bancada 60, contrapeso (1x) 50 cm.

Bancada 80, contrapeso (2x) 30 cm.

Bancada 100, contrapeso (2x) 40 cm.

Bancada 120, contrapeso (2x) 50 cm.

Enchufe interior instalado en cajón a 3 cm. del costado.



LED INFERIOR
+140€



ENCHUFE INTERIOR
+75€



bancada 1 cajón

Ref.:	Ancho hasta	Fondo hasta	Alto hasta	FANTASÍA	ARLUX	LACA SEL. MATE FENIX	MADERA
B07	60	50	34	348	425	527	616
	80	50	34	386	465	579	714
	100	50	34	418	517	666	818
	120	50	34	453	568	754	933



bancada 2 cajones

Ref.:	Ancho hasta	Fondo hasta	Alto hasta	FANTASÍA	ARLUX	LACA SEL. MATE FENIX	MADERA
B20	60	50	34	472	548	664	735
	80	50	34	508	599	752	833
	100	50	34	536	650	841	931
	120	50	34	614	704	938	1041



bancada 3 cajones

Ref.:	Ancho hasta	Fondo hasta	Alto hasta	FANTASÍA	ARLUX	LACA SEL. MATE FENIX	MADERA
B21	90	50	34	637	725	864	956
	100	50	34	669	776	963	1065
	120	50	34	696	827	1046	1159
	140	50	34	729	878	1134	1257



bancada 1 cajón / 2 cajones

Ref.:	Ancho hasta	Fondo hasta	Alto hasta	FANTASÍA	ARLUX	LACA SEL. MATE FENIX	MADERA
B23	80	50	40→48	646	803	1001	1108
	100	50	40→48	720	893	1112	1232
	120	50	40→48	847	1035	1246	1341

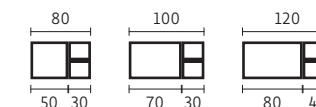

Más información e instrucciones de montaje.

BANCADAS MODULARES



Las bancadas modulares son válidas con estructura Classic y Barras.
 Se componen de coquetas y encimeras suministradas en embalajes individuales.
 Las modulaciones nos permiten crear grandes bancadas de hasta 2,2 m. de largo.
 Si van a suelo, es necesario el uso de una base (2ª encimera) y añadir patas o ruedas cada 75 cm. con el correspondiente contrapeso.

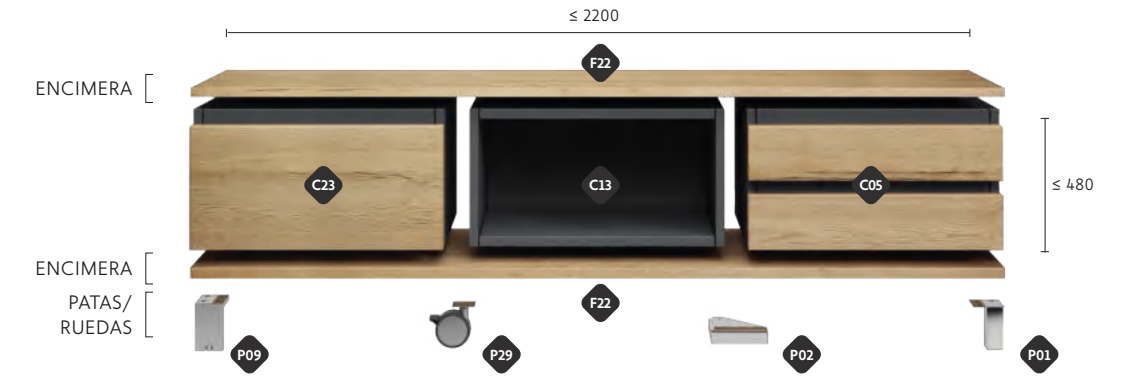

EJEMPLOS DE BANCADAS MODULARES:



2 CAJONES
 C10 + C10 + F22



1 CAJÓN / DECORATIVO
 C10 + C13 + F22



1 CAJÓN / DECORATIVO DOBLE
 C23 + C14 + F22



1 CAJÓN / DECORATIVO / 1 CAJÓN
 C10 + C13 + C10 + F22



1 CAJÓN / 2 CAJONES
 C23 + C05 + F22



1 CAJÓN / 1 CAJÓN
 C10 + C10 + F22 + F22 + P29 + CONTRAPESO



1 CAJÓN / 2 CAJONES
 C23 + C05 + F22 + P02 (x2) + F22 + CONTRAPESO



1 CAJÓN / DECORATIVO
 C10 + C13 + F22 + F22 + P10 (x3) + CONTRAPESO



05.

COMPLEMENTOS, FRENTE VITRINA Y ESTRUCTURAS



SIFONES

sifón espacio

Ref.:	Acabado	PVP
P360NC	Tapa cromo	80
P360ND	Tapa Durian*	145
P360NN	Tapa negra	80

- Incluye válvula clicker.
- Válido para todos los lavabos Durian* excepto para Milano, Florencia 60/80/100 que necesitan faldón mínimo de 5 cm.
- El cajón del mueble tiene que ser mayor o igual a 32 cm. de alto.
- Válido para todos los lavabos sobre encimera (altura cajón superior a 24 cm.).

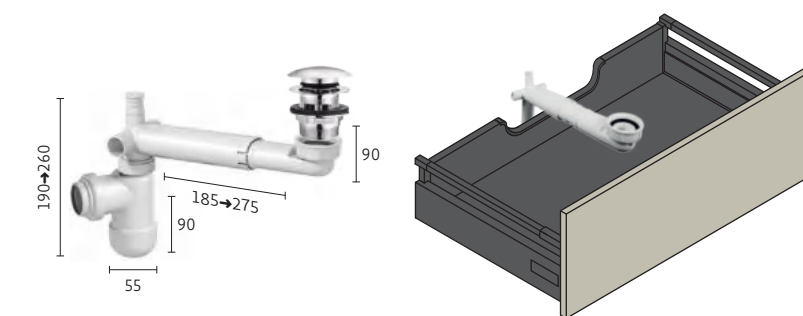

sifón estándar

Ref.:	Acabado	PVP
P370NC	Cromo	70
P370NN	Negro	80

- Incluye válvula clicker.
- Válido para todos los lavabos Durian* excepto para Milano, Sicilia 60, Florencia 60/80/100 que necesitan faldón mínimo de 5 cm.
- El cajón del mueble tiene que ser mayor o igual a 32 cm. de alto.
- Válido para todos los lavabos sobre encimera (altura cajón superior a 24 cm.).

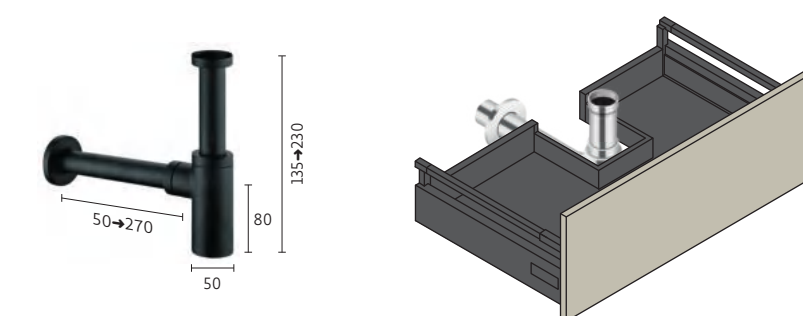

sifón seco

Ref.:	Acabado	PVP
P380NC	Tapa cromo	80
P380ND	Tapa Durian*	145
P380NN	Tapa negra	80

- Incluye válvula clicker.
- Válido para todos los lavabos Durian* excepto para Milano, Sicilia 60, Florencia 60/80/100 que necesitan faldón mínimo de 5 cm.
- El cajón del mueble tiene que ser mayor o igual a 32 cm. de alto.
- Válido para todos los lavabos sobre encimera (altura cajón superior a 24 cm.).

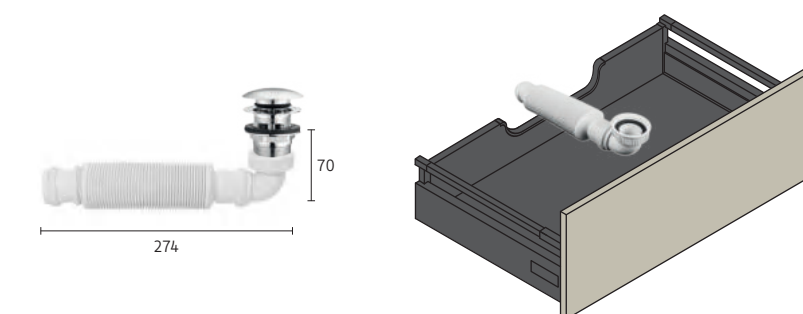

válvula clicker

Ref.:	Acabado	PVP
P31	Cromo	40
P59	Negro	40
901100000024	Durian*	105

- Incluye válvula clicker.
- Válido para todos los lavabos Durian* excepto para Milano, Sicilia 60, Florencia 60/80/100 que necesitan faldón mínimo de 5 cm.
- El cajón del mueble tiene que ser mayor o igual a 32 cm. de alto.
- Válido para todos los lavabos sobre encimera (altura cajón superior a 24 cm.).



COMPLEMENTOS CAJONES



organizadores de madera

Ref.:	Artículo	PVP
F440NN040	Kit cajón 40 (S+S+L)	70
F440NN035	Kit cajón 35 (S+S+M)	65

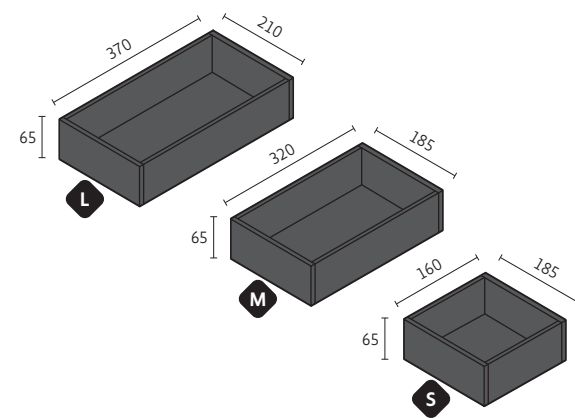

organizadores de metal

Ref.:	Artículo	Medida	PVP
P520NN029	Bandeja (1)	29 x 7,7	68
P530NN029	Cosmética (2)	29 x 15,5	70
P520NN013	Bandeja (3)	13 x 15,5	63
P510NN013	Pintalabios (4)	13 x 15,5	65
P540NN150	Papelera (5)	15 x 21	118

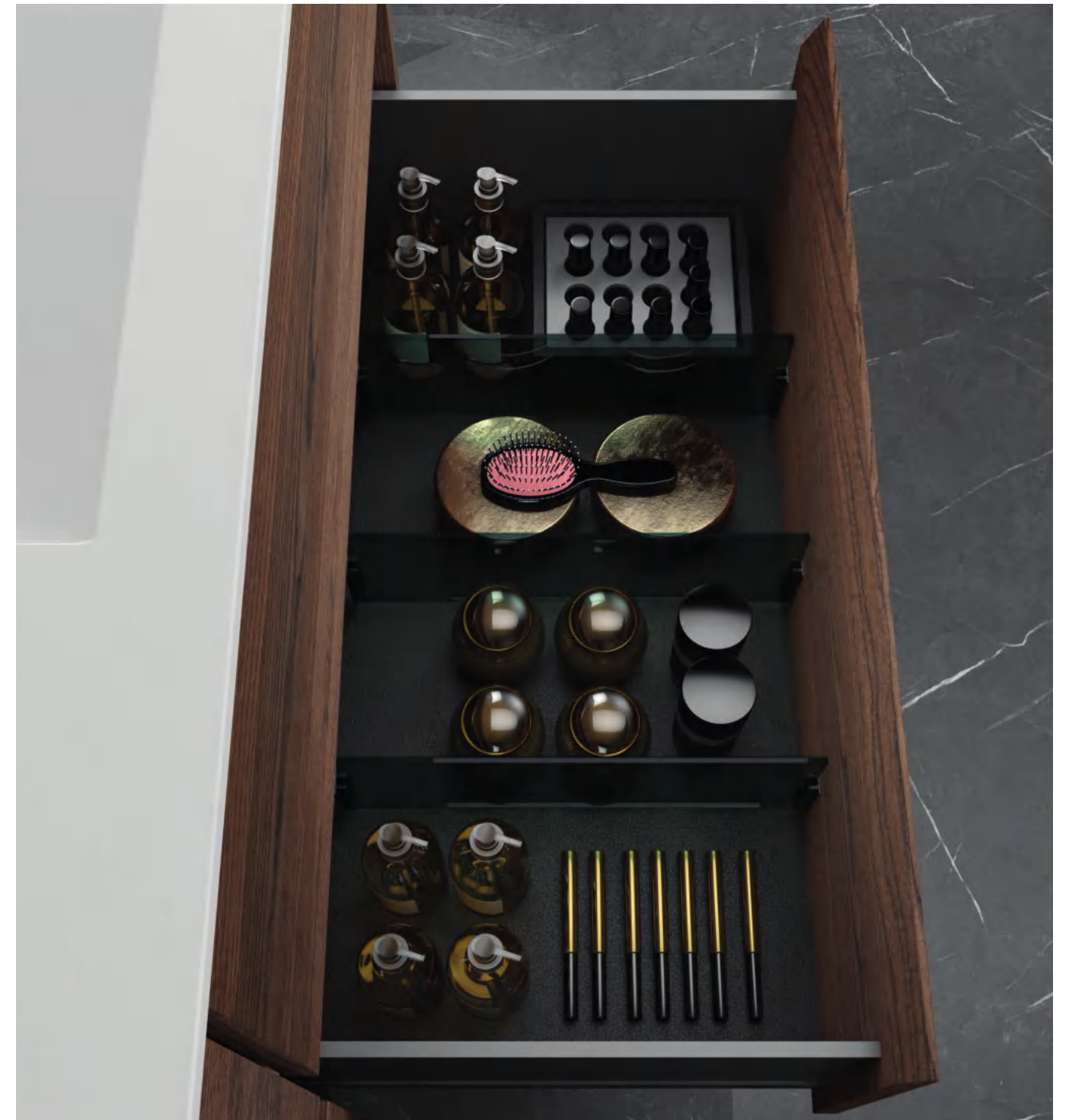
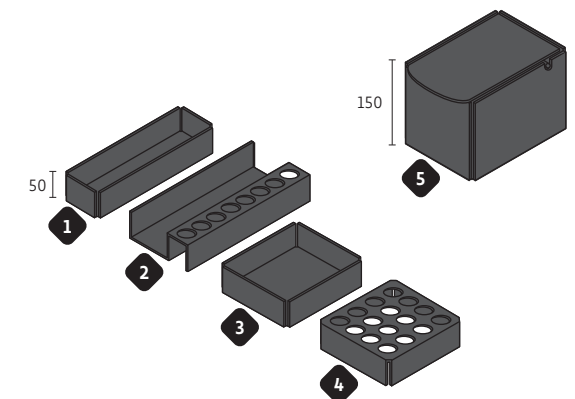

separadores vidrio templado

Ref.:	Fondo cajón	PVP
P240NN035	35	75
P240NN040	40	85

- 3 separadores de vidrio ahumado con soportes adhesivos
- Ver criterios de fondo en pág. 06.

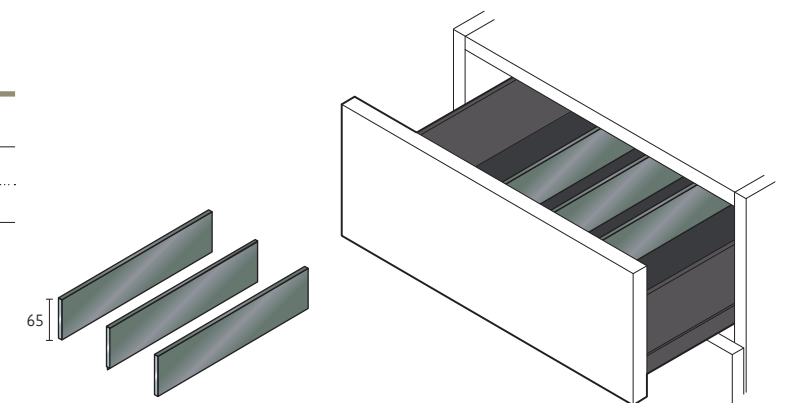

COMPLEMENTOS CAJONES

cajón interior

Ref.:	Frente	PVP
S06	Metálico STANDARD	125
S89	Metálico SCALA	125

- Frente de lavabo de encastre, altura mínima 48 cm.
- Frente de lavabo de posar y coquetas, altura mín. 32 cm.
- Bajo lavabo con escote.

Suplemento frente mismo acabado	FANTASÍA	ARLUX	LACA SEL. FENIX	MADERA
	+30	+40	+75	+95



crystal lateral para cajón STANDARD

Ref.:	Acabado	PVP
S13	Cristal	65

- Altura mínima de cajón 32 cm.
- No válido para cajón con escote.

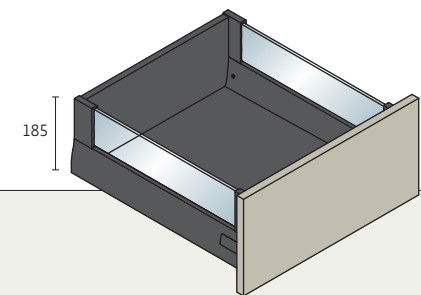
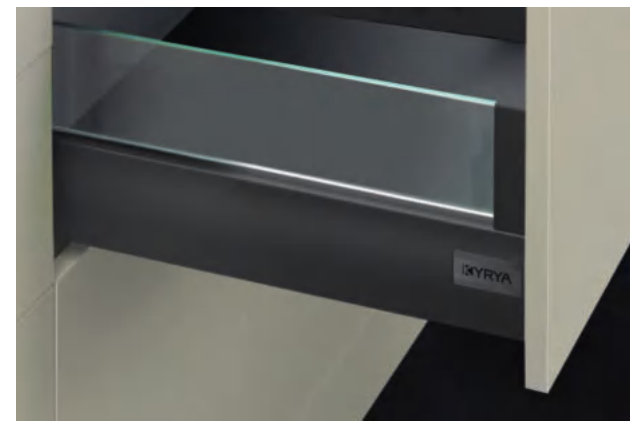

contenedor interior

Ref.:	Medida	PVP
P570NN	22 x 8 x 5h.	42

- Se suministra sin montar.

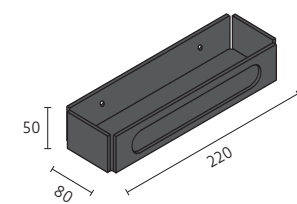

COMPLEMENTOS ELÉCTRICOS

altavoz integrado

Ref.:	Descripción	PVP
S59	Sistema sonido	280

- Receptor Bluetooth con un altavoz integrado.
- Instalación oculta en el mueble.
- Solo válido para bajo lavabos con cajón.



cargador de inducción integrado

Ref.:	Descripción	PVP
S61	Cargador wireless	140

- Indicar oculto/superficie y posición en encimera.
- No disponible en Pivstone® y oculto en Durian®.

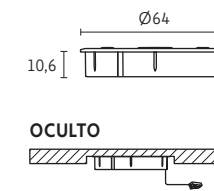

Adhesivo identificador de ubicación de carga inalámbrica en la encimera.

enchufe integrado

Ref.:	Descripción	PVP
S60	Enchufe schuko	75

- Se instala en cajón a 3 cm. del costado.

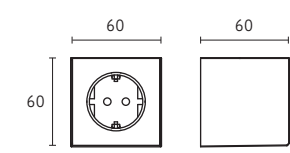

iluminación inferior bajos

Ref.:	Descripción	PVP
S88	Tira led	140

- Ver disponibilidad según modelo.
- Se suministra instalado por módulo.
- TEMPERATURA 4000°K por defecto.
- Opción 2700°K sin incremento.

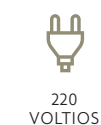

SOPORTES ENCIMERAS

	Ref.:	Artículo	Medida	Acabado	PVP
	P070NN026	Juego 2 escuadras	26 x 2,5 x 8h.	Acero galvanizado	66
	P070NN041	Juego 2 escuadras	41 x 2,5 x 8h.	Acero galvanizado	78
	P120NN026	Juego 3 escuadras	26 x 2,5 x 8h.	Acero galvanizado	90
	P120NN041	Juego 3 escuadras	41 x 2,5 x 8h.	Acero galvanizado	96
	P160NN026	Juego 2 escuadras	26 x 2,5 x 8h.	Acero inox	90
	P160NN041	Juego 2 escuadras	41 x 2,5 x 8h.	Acero inox	105
<ul style="list-style-type: none"> • Tornillería no incluida. • Uso obligado en encimeras Pivstone®. 					
	P170NN026	Juego 3 escuadras	26 x 2,5 x 8h.	Acero inox	140
	P170NN041	Juego 3 escuadras	41 x 2,5 x 8h.	Acero inox	160
<ul style="list-style-type: none"> • Tornillería no incluida. • Uso obligado en encimeras Pivstone®. 					
	P060NN030	New soporte oculto	30 x 7 x 6h.	Blanco	50
	P060NN040	New soporte oculto	40 x 7 x 6h.	Blanco	60
	P050NN035	Juego 2 soportes ángulo	35 x 15	Cromo	110
	P050NN041	Juego 2 soportes ángulo	41 x 15	Cromo	120

PATAS / RUEDAS

	Ref.:	Artículo	Medida	Acabado	PVP
	P090NX012	Juego 2 patas L	12	Negro Plata brillo	38
	P090NX024	Juego 2 patas L	24	Negro Plata brillo	45
	P08	Juego 2 patas	40 x 24	Negro Plata brillo	110
	P010NN012	Juego 4 patas square	12	Plata brillo	24
	P010NN024	Juego 4 patas square	24	Plata brillo	34
	P020NN002	Juego 2 patas bajas	2	Cromo	45
	P290NN012	Juego 4 ruedas	10	Cris	95
	P280NN006	Juego 4 ruedas	6	Negro	45
	P040N_030	Juego 2 patas cónicas	30	Laca Select Mate Madera barnizada	115
	P040N_045	Juego 2 patas cónicas	45	Laca Select Mate Madera barnizada	155
<ul style="list-style-type: none"> • Herrajes rectos e inclinados incluidos. • Obligatorio colgar el mueble en pared. 					



TOALLEROS

toallero verso

Ref.:	Medida	PVP
P18	38,5 x 5 x 3,5h.	65

• Se suministra para fijar con tornillos.

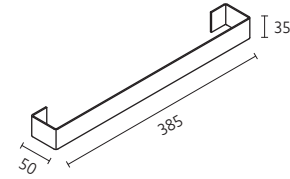

toallero flat

Ref.:	Medida	PVP
P14	30 x 8,5 x 11,5h.	63

• Válido solo para bajo lavabos.
• Fijación con tornillos en el interior del mueble.

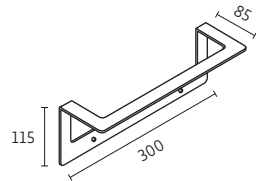

toallero mix

Ref.:	Medida	PVP
P15	30 x 6,5 x 11,5h.	63

• Válido solo para bajo lavabos.
• Se suministra para colgar sin tornillos.

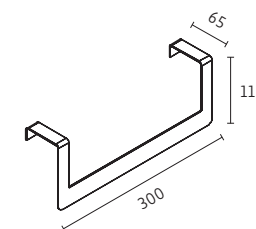

toallero lateral

Ref.:	Medida	PVP
P11	37 x 5,5 x 6h.	60

• Válido solo para bajo lavabos.
• Se suministra para colgar en costados de 2 cm.

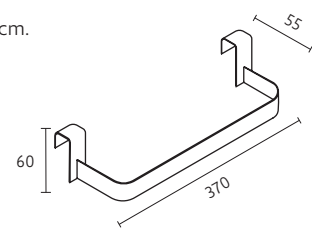

ACCESORIOS

percha

Ref.:	Medida	PVP
P19	2 x 2,7 x 6,8h.	30

• Válido solo para bajo lavabos.
• Se suministra para colgar en costados de 2 cm.

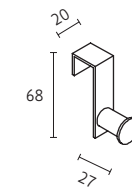
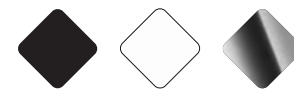

porta papel higiénico

Ref.:	Medida	PVP
P20	7,5 x 14,2 x 6,8h.	40

• Válido solo para bajo lavabos.
• Se suministra para colgar en costados de 2 cm.

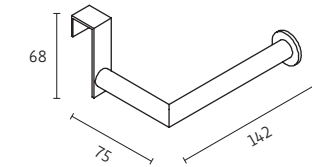
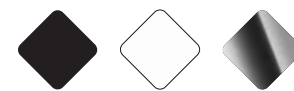

porta planchas

Ref.:	Medida	PVP
P21	7,5 x 6,8h.	50

• Válido solo para bajo lavabos.
• Se suministra para colgar en costados de 2 cm.

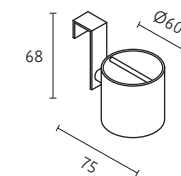
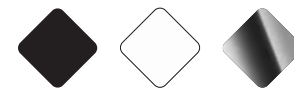

porta secador

Ref.:	Medida	PVP
P22	10 x 6,8h.	33

• Válido solo para bajo lavabos.
• Se suministra para colgar en costados de 2 cm.

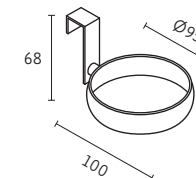
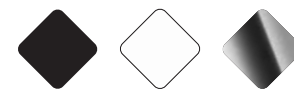

FRENTES VITRINA



Frontales de perfil metálico negro con ñero integrado y cristal ahumado que se adaptan a casi todos los muebles.

cajón Scala FRENTE VITRINA PARA CAJÓN SCALA INCLUIDO

Ref.:	Ancho hasta	Alto hasta	PVP
S56	60	32	148
	80	32	167
	100	32	184
	120	32	203
S56	60	48	169
	80	48	192
	100	48	215
	120	48	238

• Tirador horizontal.

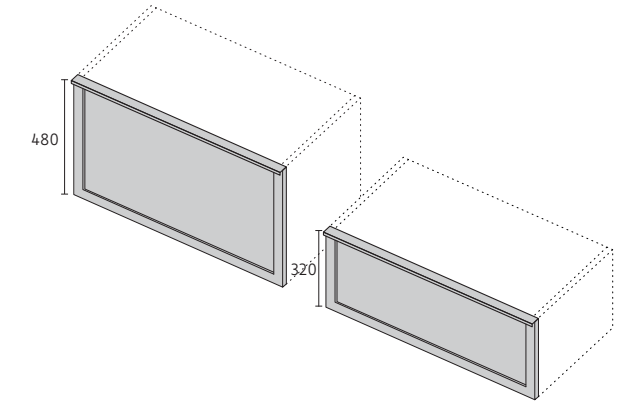

puerta bajo lavabo/coqueta SUPLEMENTO FRENTE VITRINA

Ref.:	Ancho hasta	Alto	PVP
S57	50	48	162
	60	48	178
S57	50	64	181
	60	64	199

• Tirador vertical.

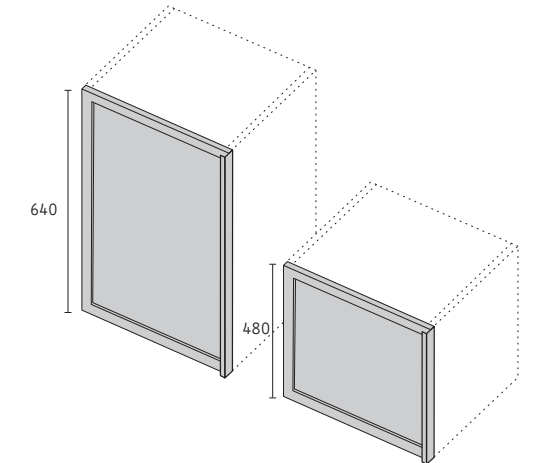

puerta alto SUPLEMENTO FRENTE VITRINA

Ref.:	Ancho hasta	Alto hasta	PVP
S57	30	70	154
	35	70	161
	40	70	169
	45	70	176

• Tirador vertical.

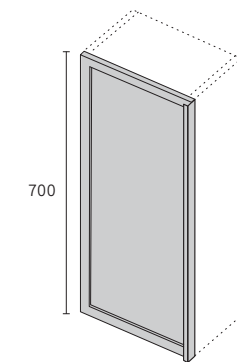

puerta columna SUPLEMENTO FRENTE VITRINA

Ref.:	Ancho hasta	Alto hasta	PVP
S57	25	140	205
	35	140	230
	45	140	253
S57	25	160	222
	35	160	248
	45	160	276

• Tirador vertical.

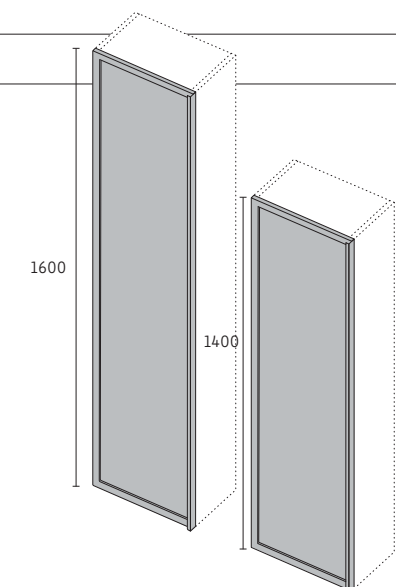

Más información e instrucciones de montaje.

www.kyrya.es



ESTRUCTURAS METÁLICAS



46
FONDO hasta 46 cm. SIN INCREMENTO



47-55
FONDO hasta 55 cm. +20%



ACERO SEMIPULIDO
2x2 cm.

Los precios que figuran en esta tarifa son PVP recomendados, salvo error tipográfico. IVA y montaje no incluidos.



A TOALLERO EXENTO (indicar mano)

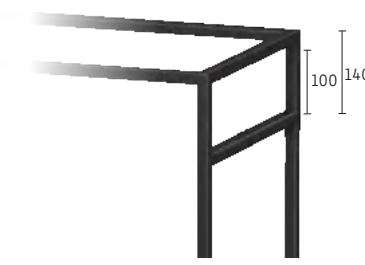

B TOALLERO LATERAL (indicar mano)

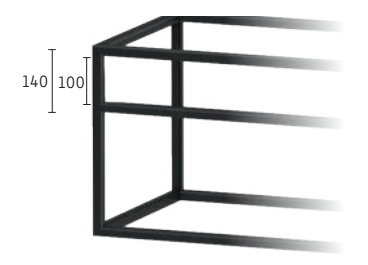

D TOALLERO FRONTAL

estructura suspendida M



Ref.:	Ancho hasta	Fondo hasta	Alto hasta	ESTRUCTURA	TOALLERO EXENTO A
J03	60	46	40	459	75
	80	46	40	498	75
	100	46	40	570	75
	120	46	40	630	75

- Incluye sujeción a pared.
- No apto para introducir bajo lavabos.



estructura suspendida XL



Ref.:	Ancho hasta	Fondo hasta	Alto hasta	ESTRUCTURA	TOALLERO LATERAL B	TOALLERO FRONTAL D	TOALLERO EXENTO A
J02	60	46	55	555	45	90	75
	80	46	55	610	45	90	75
	100	46	55	685	45	90	75
	120	46	55	745	45	90	75

- Incluye sujeción a pared.
- No apto para introducir bajo lavabos.
- Toallero lateral estándar a 12 cm. de la encimera. Indicar mano.
- Toallero frontal estándar a 12 cm. de la encimera.

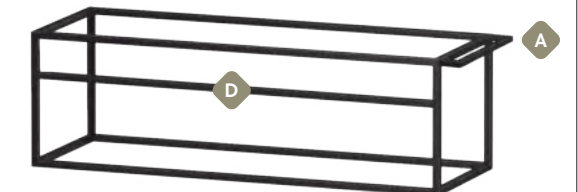

estructura a suelo



Ref.:	Ancho hasta	Fondo hasta	Alto hasta	ESTRUCTURA	TOALLERO LATERAL B	TOALLERO FRONTAL D	TOALLERO EXENTO A
J01	60	46	88	520	45	90	75
	80	46	88	575	45	90	75
	100	46	88	640	45	90	75
	120	46	88	695	45	90	75
	140	46	88	740	45	90	75

- Incluye sujeción a pared.
- No apto para introducir bajo lavabos.
- Altura patas 12 cm., consultar otras medidas.

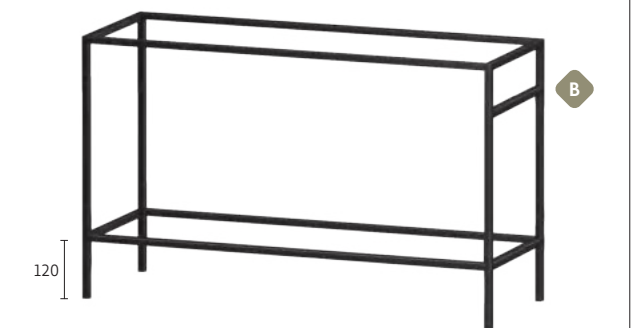

Más información e instrucciones de montaje.

COMPLEMENTOS ESTRUCTURAS METÁLICAS

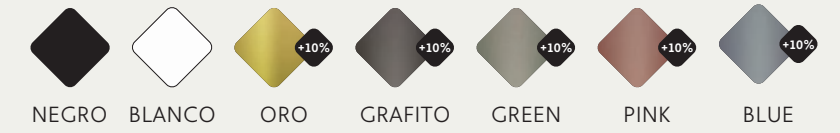

estructura a suelo para bajo lavabo

Ref.:	Ancho hasta	Fondo hasta	Alto hasta	ESTRUC-TURA	TOALLERO EXENTO
J12	60	46	88	494	75
	80	46	88	546	75
	100	46	88	608	75
	120	46	88	660	75

- Incluye sujeción a pared.



toallero techo

Ref.:	Ancho hasta	Alto hasta	Perfil	PVP
J07	60	90	2x2	355

- Tornillería no incluida.
- Distribución fija.

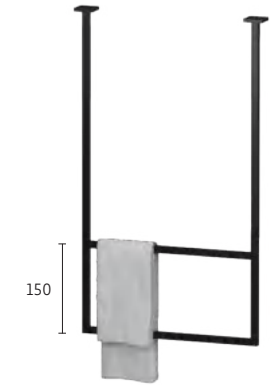

estructura soporte lateral encimera

Ref.:	Alto hasta	Fondo	Perfil	PVP
J04	30	46	2x2	145
J05	88	46	2x2	215

- Incluye sujeción a pared.
- J05 opción toalleros A y B.



toallero suelo

Ref.:	Ancho hasta	Alto	Perfil	PVP
J06	60	180	2x2	475

- Distribución fija.
- Sin sujeción a pared.

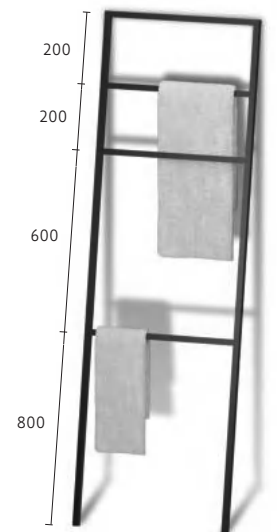

suplemento faldón superior 3 lados

Ref.:	Ancho hasta	Fondo hasta	Alto	FANTASÍA	ARLUX	LACA SEL. MATE FENIX	MADERA
F31	60	46	10	133	152	217	241
	80	46	10	146	170	237	264
	100	46	10	163	184	256	285
	120	46	10	183	209	284	317

- Altura estándar mínima 2+10+2.
- Se suministra instalado.
- El precio incluye las barras horizontales.

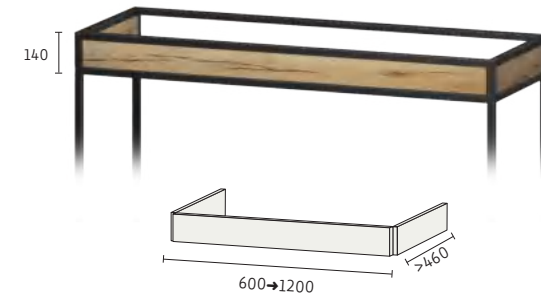

suplemento encimera base

Ref.:	Ancho hasta	Fondo hasta	Grosor	FANTASÍA	ARLUX	LACA SEL. MATE FENIX	MADERA
F22	60	51	1,9	89	115	167	191
	80	51	1,9	105	135	197	225
	100	51	1,9	122	160	230	265
	120	51	1,9	146	192	278	319

- Se suministra suelto.



estructura con 5 repisas

Ref.:	Ancho hasta	Fondo	FANTASÍA	ARLUX	LACA SEL. MATE FENIX	MADERA
J11/F37	60	44	862	902	968	996
	90	44	1121	1173	1258	1295

- Se suministra desmontado.
- Distribución fija.
- Sujeción a pared.



06. A



LACA RAL
MATE/BRILLO +15%
METALIZADO +20%

ALTOS BÁSICOS Y DECORATIVOS

De no indicar lo contrario el frente uñero se suministra con puerta recta y bases remetidas.

Las baldas internas tienen un grosor de 1,6 cm.

El tirador se suministrará en posición vertical. Cambio medida o posición +30€/puerta.

Fondo mínimo 15 cm. (puerta incluida).

El número de baldas depende de la altura de la puerta:
1 balda. 40→59 cm. / 2 baldas. 60→94 cm.

Cremallera 3 posiciones no disponible con apertura Push.

 CREMALLERA 3 POSICIONES +30€	 BALDA CRISTAL +35€/und.	 BALDA INTERIOR EXTRA +30€	 ENCHUFE INTERIOR +75€
---	--	---	--

 ESPEJO INT. ó EXT. +60€/und.	 LED INFERIOR +140€	 LED INTERIOR +140€
---	---	---

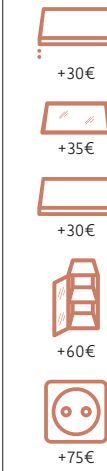

1 puerta

Ref.:	Ancho hasta	Fondo hasta	Alto hasta	FANTASÍA	ARLUX	LACA SEL. MATE FENIX	MADERA
A02	30	19	80	201	235	356	399
	35	19	80	214	247	373	418
	40	19	80	226	261	389	436
	45	19	80	252	294	418	500

• Indicar mano.

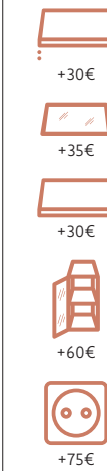
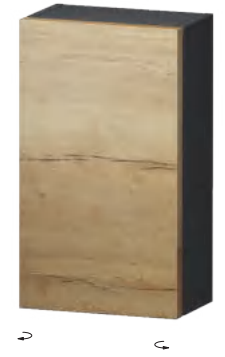

2 puertas

Ref.:	Ancho hasta	Fondo hasta	Alto hasta	FANTASÍA	ARLUX	LACA SEL. MATE FENIX	MADERA
A10	40	19	80	261	291	461	521
	50	19	80	280	314	504	563
	60	19	80	297	337	522	574

• No disponible con tirador Gina.



culo 1 puerta

Ref.:	Ancho hasta	Fondo hasta	Alto hasta	FANTASÍA	ARLUX	LACA SEL. MATE FENIX	MADERA
A01	30	19	40	170	196	259	292
	40	19	40	185	213	286	332

• Indicar mano.
• No incluye balda.

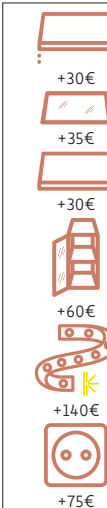

1 puerta / 1 cajón

Ref.:	Ancho hasta	Fondo hasta	Alto hasta	FANTASÍA	ARLUX	LACA SEL. MATE FENIX	MADERA
A18	30	24	80	298	390	435	507
	35	24	80	312	421	461	516
	40	24	80	324	438	489	549

• Indicar mano.
• Cajón con guía bolas, altura fija 16 cm. y fondo 24 cm.
• No admite Push.



- +30€
- +35€
- +30€
- +60€
- +75€

1 puerta con decorativo

Ref.:	Ancho hasta	Fondo hasta	Alto hasta	FANTASÍA	ARLUX	LACA SEL. MATE FENIX	MADERA
A03	30	19	80	229	287	386	437
	40	19	80	257	305	432	477

- Indicar mano.
- Puerta 1 cm. con vuelo inferior sobre el hueco.



160

- +30€
- +35€
- +30€
- +60€
- +75€

1 puerta / repisas

Ref.:	Ancho hasta	Fondo hasta	Alto hasta	FANTASÍA	ARLUX	LACA SEL. MATE FENIX	MADERA
A28	40	19	70	290	336	495	532
	50	19	70	311	363	552	608
	60	19	70	325	386	610	669

- Apertura vuelo lateral de puerta 1 cm.



- +30€
- +35€
- +30€
- +60€
- +140€
- +75€

2 puertas / 1 cajón

Ref.:	Ancho hasta	Fondo hasta	Alto hasta	FANTASÍA	ARLUX	LACA SEL. MATE FENIX	MADERA
A19	40	24	80	375	456	529	596
	50	24	80	388	489	583	644
	60	24	80	412	522	634	704

- Cajón con guía bolas, altura fija 16 cm. y fondo 24 cm.
- No disponible con tirador Gina y Push.



160

240

- +140€

cubo decorativo

Ref.:	Ancho hasta	Fondo hasta	Alto hasta	FANTASÍA	ARLUX	LACA SEL. MATE FENIX	MADERA
A12	30	19	40	124	156	217	265
	40	19	40	137	175	238	282

- Sistema de regulación superior visto.
- Regulación frontal con embellecedor metálico opcional.



- +30€
- +35€
- +30€
- +60€
- +75€

2 puertas con decorativo

Ref.:	Ancho hasta	Fondo hasta	Alto hasta	FANTASÍA	ARLUX	LACA SEL. MATE FENIX	MADERA
A04	40	19	80	279	356	472	521
	50	19	80	303	390	497	541
	60	19	80	322	414	555	621

- Puerta 1 cm. con vuelo inferior sobre el hueco.
- No disponible con tirador Gina.



160

- +140€

2 huecos horizontal

Ref.:	Ancho hasta	Fondo hasta	Alto hasta	FANTASÍA	ARLUX	LACA SEL. MATE FENIX	MADERA
A06	60	19	40	170	212	302	373
	70	19	40	190	226	318	393
	80	19	40	204	237	340	440

- Sistema de regulación superior visto.
- Regulación frontal con embellecedor metálico opcional.
- Huecos simétricos.



- +30€
- +35€
- +30€
- +60€
- +75€

2 puertas con decorativo

Ref.:	Ancho hasta	Fondo hasta	Alto hasta	FANTASÍA	ARLUX	LACA SEL. MATE FENIX	MADERA
A05	90	19	40	321	433	544	604
	110	19	40	359	485	609	688

- Apertura vuelo lateral de puerta 1 cm.
- Huecos simétricos.



- +140€

3 huecos horizontal

Ref.:	Ancho hasta	Fondo hasta	Alto hasta	FANTASÍA	ARLUX	LACA SEL. MATE FENIX	MADERA
A07	90	19	40	219	267	392	471
	110	19	40	244	290	432	509

- Sistema de regulación superior visto.
- Regulación frontal con embellecedor metálico opcional.
- Huecos simétricos.





2 huecos vertical

Ref.:	Ancho hasta	Fondo hasta	Alto hasta	FANTASÍA	ARLUX	LACA SEL. MATE FENIX	MADERA
A13	30	19	80	170	208	302	373
	40	19	80	190	220	318	393

- Sistema de regulación superior visto.
- Regulación frontal con embellecedor metálico opcional.
- Huecos simétricos.



3 huecos vertical

Ref.:	Ancho hasta	Fondo hasta	Alto hasta	FANTASÍA	ARLUX	LACA SEL. MATE FENIX	MADERA
A47	30	19	100	213	264	368	458
	40	19	100	237	287	405	496

- Sistema de regulación superior visto.
- Regulación frontal con embellecedor metálico opcional.
- Huecos simétricos.



alto 2 baldas

Ref.:	Ancho hasta	Fondo hasta	Alto hasta	FANTASÍA	ARLUX	LACA SEL. MATE FENIX	MADERA
A25	30	19	80	120	170	204	254
	40	19	80	145	188	230	292



alto 3 baldas

Ref.:	Ancho hasta	Fondo hasta	Alto hasta	FANTASÍA	ARLUX	LACA SEL. MATE FENIX	MADERA
A26	30	19	100	148	210	248	316
	40	19	100	181	233	283	362



decorativo abierto espejo

Ref.:	Ancho hasta	Fondo hasta	Alto hasta	FANTASÍA	ARLUX	LACA SEL. MATE FENIX	MADERA
A08	30	19	100	231	325	431	494
	40	19	100	255	358	469	545

- Hueco abierto por ambos lados.



DECORATIVO INTERIOR

interior deco 4 caras

Ref.:	Ancho hasta	Fondo hasta	Alto hasta	FANTASÍA	ARLUX	LACA SEL. MATE FENIX	MADERA
A121	30	24	40	92	117	163	198
	40	24	40	103	130	181	212

- Grosor 12 mm. para Laca y Madera.
- Grosor 19 mm. para Fantasía, Arlux y Fenix.
- Se suministra montado en el interior de su decorativo.



interior deco 5 caras

Ref.:	Ancho hasta	Fondo hasta	Alto hasta	FANTASÍA	ARLUX	LACA SEL. MATE FENIX	MADERA
A122	30	24	40	103	129	195	239
	40	24	40	114	145	216	256

- Grosor 12 mm. para Laca y Madera.
- Grosor 19 mm. para Fantasía, Arlux y Fenix.
- Se suministra montado en el interior de su decorativo.



06. B



LACA RAL
MATE/BRILLO +15%
METALIZADO +20%

COLUMNAS

Fondo mínimo cajón 32,5 cm.

El frente uñero se suministra según indicación por modelo.

Las baldas interiores tienen un grosor de 1,6 cm.

Altura máxima en puertas, 160 cm.

Si la altura de la puerta es superior a 120 cm, la veta del acabado Madera será en posición vertical.





De no indicar lo contrario en las puertas, el tirador se suministrará en posición vertical, cambio de medida o posición +30€/mód.

Decorativo interior ver pág. 81.

El número de baldas según la altura de la puerta:
1 balda (40→59 cm.) / 2 baldas (60→94 cm.)
3 baldas (95→138 cm.) / 4 baldas (139→160 cm.)

Cremallera 3 posiciones no disponible con apertura Push.

-  **CREMALLERA 3 POSICIONES**
+30€
-  **BALDA CRISTAL**
+35€/und.
-  **BALDA INTERIOR EXTRA** +30€
-  **CAJÓN EXTRA**
+125€

-  **ESPEJO INT. ó EXT.**
+90€/und.
-  **TOLVA CAJÓN**
+115€
-  **TOLVA METÁLICA**
+115€
-  **LUZ INT. CON SENSOR**
+265€



1 puerta

Ref.:	Ancho hasta	Fondo hasta	Alto hasta	FANTASÍA	ARLUX	LACA SEL. MATE FENIX	MADERA
M03	25	24	140	282	341	490	559
	35	24	140	306	358	524	613
	45	24	140	331	381	582	671

- Indicar mano.
- En apertura uñero, la puerta se suministra 1 cm. mas ancha que la estructura. También válido para cualquier tirador o Push.



2 puertas

Ref.:	Ancho hasta	Fondo hasta	Alto hasta	FANTASÍA	ARLUX	LACA SEL. MATE FENIX	MADERA
M04	25	24	140	335	408	544	609
	35	24	140	355	440	607	674
	45	24	140	385	477	679	779
M05	25	35	180	411	493	768	882
	35	35	180	448	527	844	961
	45	35	180	485	569	905	1018

- Indicar mano.



2 puertas / 1 decorativo

Ref.:	Ancho hasta	Fondo hasta	Alto hasta	FANTASÍA	ARLUX	LACA SEL. MATE FENIX	MADERA
M36	25	24	140	370	439	583	645
	35	24	140	388	464	659	723
	45	24	140	425	513	755	820
M46	25	35	180	444	544	813	899
	35	35	180	467	574	918	1007
	45	35	180	510	635	1052	1143

- Indicar mano. Hueco a ras de armazón siempre de 30 cm.
- Opción decorativo interior, ver pág. 81.
- Apertura abajo y arriba con vuelo sobre decorativo.







2 puertas / 1 cajón

Ref.:	Ancho hasta	Fondo hasta	Alto hasta	FANTASÍA	ARLUX	LACA SEL. MATE FENIX	MADERA
M23	35	35	140	502	588	832	919
	45	35	140	547	646	934	1010
M24	35	35	180	562	709	993	1115
	45	35	180	603	762	1108	1295

- Indicar mano.
- Fondo mínimo columna con cajón, 32,5 cm.
- Medida fija de cajón 16 cm.





1 puerta / 1 cajón





 +30€
 +35€
 +30€
 +90€

Ref.:	Ancho hasta	Fondo hasta	Alto hasta	FANTASÍA	ARLUX	LACA SEL. MATE FENIX	MADERA
M22	35	35	140	461	567	807	915
	45	35	140	495	622	892	1011
M25	35	35	180	497	630	900	1018
	45	35	180	534	666	1012	1148

- Indicar mano.
- Fondo mínimo columna con cajón, 32,5 cm.
- Medida fija de cajón 30 cm.



4 puertas



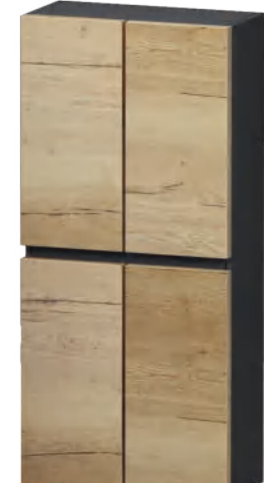

 +30€
 +35€
 +30€
 +90€

Ref.:	Ancho hasta	Fondo hasta	Alto hasta	FANTASÍA	ARLUX	LACA SEL. MATE FENIX	MADERA
M42	50	24	140	525	646	814	1002
	65	24	140	570	712	892	1071
	80	24	140	614	773	953	1128
M43	50	35	180	632	773	984	1196
	65	35	180	687	836	1063	1243
	80	35	180	743	896	1123	1307

- No disponible con tirador Gina.



1 puerta / 1 decorativo



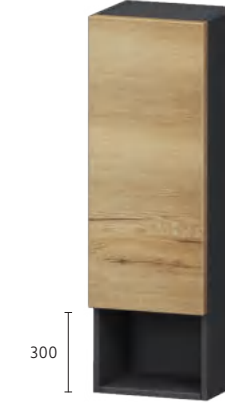

 +30€
 +35€
 +30€
 +90€

Ref.:	Ancho hasta	Fondo hasta	Alto hasta	FANTASÍA	ARLUX	LACA SEL. MATE FENIX	MADERA
M37	25	24	140	289	380	600	702
	35	24	140	320	412	659	766
	45	24	140	353	465	728	856

- Indicar mano.
- Hueco a ras de armazón con altura fija de 30 cm.
- Opción decorativo interior, ver pág. 81.
- Apertura inferior con vuelo sobre decorativo.





1 puerta / 3 decorativos



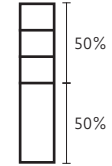

 +30€
 +35€
 +30€
 +90€

Ref.:	Ancho hasta	Fondo hasta	Alto hasta	FANTASÍA	ARLUX	LACA SEL. MATE FENIX	MADERA
M38	25	24	180	399	541	832	936
	35	24	180	436	595	922	1034
	45	24	180	472	645	1005	1132

- Indicar mano.
- Huecos a ras de armazón siempre 50%.
- Apertura superior con vuelo sobre decorativo.
- Sistema de regulación superior visto.





2 puertas

 +30€
 +35€
 +30€
 +90€

Ref.:	Ancho hasta	Fondo hasta	Alto hasta	FANTASÍA	ARLUX	LACA SEL. MATE FENIX	MADERA
M32	50	24	140	435	526	660	783
	65	24	140	476	574	726	823
	80	24	140	513	614	787	884

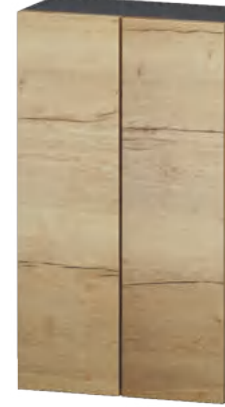
- Apertura sólo con Push o tirador.
- No disponible con tirador Gina.



1 puerta / repisa



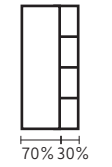
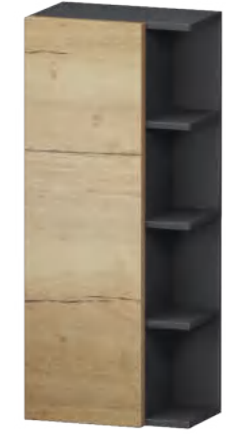

 +90€

Ref.:	Ancho hasta	Fondo hasta	Alto hasta	FANTASÍA	ARLUX	LACA SEL. MATE FENIX	MADERA
M30	50	24	140	356	526	763	939
	60	24	140	385	563	843	1021

- Puerta 1 cm. siempre más ancha que la estructura.





2 puertas / 1 decorativo

 +30€
 +35€
 +30€
 +90€

Ref.:	Ancho hasta	Fondo hasta	Alto hasta	FANTASÍA	ARLUX	LACA SEL. MATE FENIX	MADERA
M33	50	24	140	439	563	796	921
	65	24	140	475	616	861	960
	80	24	140	513	659	923	1021

- Hueco a ras de armazón.
- Opción decorativo interior, ver pág. 81.
- Apertura inferior con vuelo sobre decorativo.
- No disponible con tirador Gina.





mixta

 +90€

Ref.:	Ancho hasta	Fondo hasta	Alto hasta	FANTASÍA	ARLUX	LACA SEL. MATE FENIX	MADERA
M31	50	24	140	437	612	860	1075
	60	24	140	472	650	912	1182

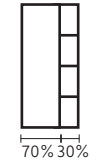
- Huecos a ras de armazón.
- Sistema de regulación superior visto.
- Puerta 1 cm. siempre más ancha que la estructura.

decorativo abierto lateral

Ref.:	Ancho hasta	Fondo hasta	Alto hasta	FANTASÍA	ARLUX	LACA SEL. MATE FENIX	MADERA
M72	30	24	140	313	401	554	670
	40	24	140	350	444	604	732

- Hueco abierto por ambos lados.
- Sistema de regulación superior visto.



decorativo lateral

- +30€
- +35€
- +30€
- +90€

Ref.:	Ancho hasta	Fondo hasta	Alto hasta	FANTASÍA	ARLUX	LACA SEL. MATE FENIX	MADERA
M34	30→39	50	180	614	828	1241	1572
	50	50	180	650	904	1381	1721



decorativo 4 huecos

Ref.:	Ancho hasta	Fondo hasta	Alto hasta	FANTASÍA	ARLUX	LACA SEL. MATE FENIX	MADERA
M21	30	24	140	244	330	503	661
	40	24	140	275	346	527	697

- Sistema de regulación superior visto.



decorativo 8 huecos

Ref.:	Ancho hasta	Fondo hasta	Alto hasta	FANTASÍA	ARLUX	LACA SEL. MATE FENIX	MADERA
M45	50	24	140	306	412	706	858
	60	24	140	335	456	787	971
	70	24	140	370	500	851	1060

- Sistema de regulación superior visto.



COLUMNAS LAVADERO

escobero

Ref.:	Ancho hasta	Fondo hasta	Alto hasta	FANTASÍA	ARLUX	LACA SEL. MATE FENIX	MADERA
M47	50	35	200	850	879	1435	1502
	65	35	200	870	906	1562	1631
	80	35	200	897	933	1689	1762

- Indicar mano posición de baldas.
- Altura zócalo 10 cm.



lavadora y secadora

Ref.:	Ancho hasta	Fondo hasta	Alto hasta	FANTASÍA	ARLUX	LACA SEL. MATE FENIX	MADERA
M48	70	65→70	200	891	910	1909	2260
	80	65→70	200	905	925	1995	2356
M481	Modelo desmontado			891	910	1909	2260
	Modelo desmontado			905	925	1995	2356

- 4 puertas simétricas.
- Zócalo desmontable.
- No válido con tirador Gina.
- No válido para sistemas de apertura con calle.
- Válido con apertura Push.



COLUMNAS



columna always

Ref.:	Ancho	Fondo	Alto	FANTASÍA	ARLUX	LACA SEL. MATE FENIX	MADERA
	35	15	180	611	656	806	906
M73	45	15	180	641	686	836	936
	55	15	180	712	757	907	1007



+265€

- Puerta espejo 4 mm con trasera, armazón rectangular, ver ficha técnica.
- Opción iluminación interior con sensor, luz led 4000°K ubicada en lado contrario a las bisagras.
- Baldas interiores cristal fume templado

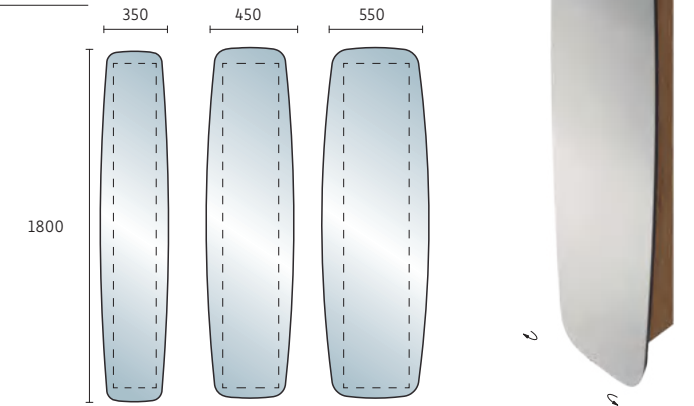

columna new naya

Ref.:	Ancho	Fondo	Alto	FANTASÍA	ARLUX	LACA SEL. MATE FENIX	MADERA
	35	15	180	611	656	806	906
M74	45	15	180	641	686	836	936
	55	15	180	712	757	907	1007



+265€

- Puerta espejo 4 mm con trasera, armazón rectangular, ver ficha técnica.
- Opción iluminación interior con sensor, luz led 4000°K ubicada en lado contrario a las bisagras.
- Baldas interiores cristal fume templado

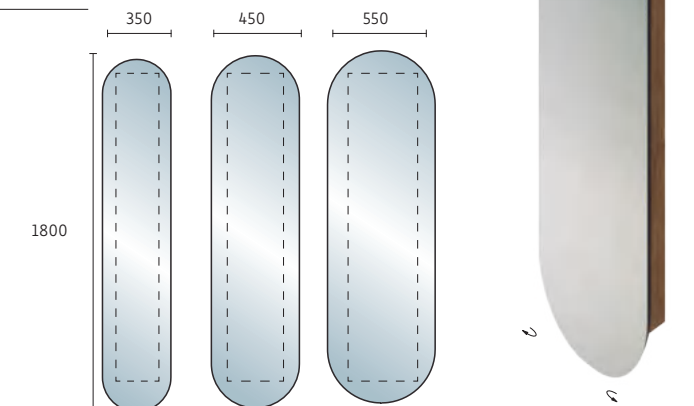

columna giratoria 5 huecos

Ref.:	Ancho	Fondo	Alto	FANTASÍA	ARLUX	LACA SEL. MATE FENIX	MADERA
M54	29	29	184	631	696	868	975
M541	29	29	204	719	794	1008	1131



SET
BARANDILLA
NEGRA
+50€

- Fondo total (mueble+herraje) 38 cm.
- Fondo con mueble en posición diagonal 45 cm.



07.

ESPEJOS CAMERINOS ILUMINACIÓN

COLECCIÓN NEW INFINITY LED	p.92
COLECCIÓN FRAME	p.94
COLECCIÓN FORMS	p.96
COLECCIÓN PENDENT	p.100
COLECCIÓN METÁLICOS RECTOS	p.102
COLECCIÓN METÁLICOS CURVOS	p.104
COLECCIÓN CONTOUR	p.106
COLECCIÓN SAND	p.108
COLECCIÓN COMBI	p.110
COLECCIÓN LACK	p.112
COLECCIÓN CLASSIC	p.114
COLECCIÓN DECO	p.120
CAMERINOS PUERTA ESPEJO	p.122
CAMERINOS DOBLE ESPEJO	p.124
ILUMINACIÓN	p.126



+10% cada 10 cm.

MEDIDAS SUPERIORES.
Solo en espejos indicados.



ESPEJO SIN TRASERA.
Ancho máximo 120 cm.



+35€ precio neto

ESPEJO SUELTO.
Transporte y embalaje especial.



TRASERA GROSOR 19/25 mm.
Permite realizar formatos de hasta 200 cm. dependiendo del modelo.



+140€/ und.

ILUMINACIÓN INTERIOR LED SUPERIOR.



+265€/ und.

ILUMINACIÓN INTERIOR CON SENSOR, LED LATERAL.



+80€/und.

SENSOR LATERAL INFRARROJO POR MOVIMIENTO (ON/OFF).
Se suministra a la derecha. Para su correcto funcionamiento necesita mínimo 10 cm. sin obstáculos.



+110€/und.

ENCENDIDO FRONTAL TÁCTIL CON INDICADOR LED (ON/OFF).
No compatible con SEGURGLASS ni espejo de aumento.



LA VETA DE LA MADERA ES SIEMPRE HORIZONTAL.



+70€/und.

LA PLACA ANTIVAHO 40x40
Para medidas superiores a 60x60
Consumo 36W.



+155€/und.

ESPEJO DE 5 AUMENTOS INTEGRADO
Se ubica a 10 cm. del borde y centrado en altura. Opción izq./dch. No compatible con SEGURGLASS ni sensor frontal.



+295€/und.

ESPEJO DE 5 AUMENTOS INTEGRADO E ILUMINADO
Se ubica a 10 cm. del borde y centrado en altura. Opción izq./dch. No compatible con SEGURGLASS ni sensor frontal.



CAMBIO DE HORIENTACIÓN
Sin incremento en espejos indicados.



+90€/und.

SEGURGLASS
En caso de rotura evita el desprendimiento del vidrio.



TEMPERATURA 4000°K.
Opción 2700°K sin incremento.



FICHAS TÉCNICAS

COLECCIÓN

NEW INFINITY LED



new infinity top

Ref.:	Ancho hasta	Alto hasta	PVP
E880	70	80	419
	80	80	429
	90	80	442
	100	80	453
	120	80	579
	140	80	603

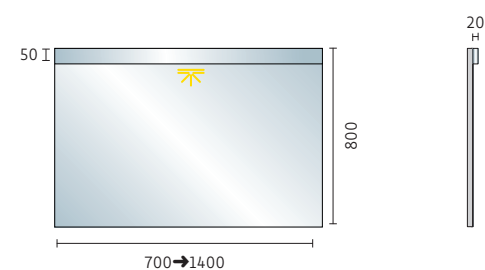

new infinity line

Ref.:	Ancho hasta	Alto hasta	PVP
E890	70	80	406
	80	80	419
	90	80	428
	100	80	441
	120	80	567
	140	80	591

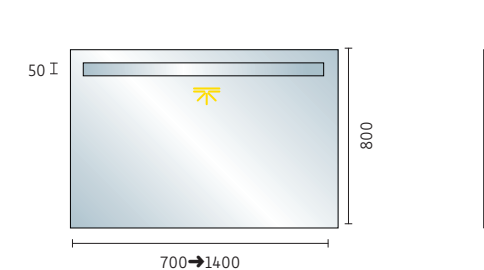

+10%x10



+80€



+70€



+10%x10



+80€



+70€



COLECCIÓN
FRAME



redondo

Ref.:	Diámetro	Perímetro 1,5	Perímetro 1,5 + luz ambiente
E730	Ø60	254	407
	Ø80	312	482
	Ø100	384	561

• Perfil negro de 1,5 cm. pintado bajo el cristal.



+70€

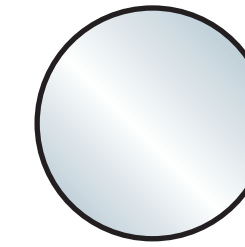

Ø 600 / 800 / 1000



15



hexagonal

Ref.:	Ancho	Perímetro 1,5	Perímetro 1,5 + luz ambiente
E740	60	212	362
	80	264	430
	100	324	507

• Perfil negro de 1,5 cm. pintado bajo el cristal.



+80€



+70€

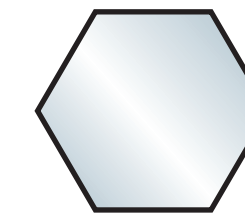

600 / 800 / 1000



15



octogonal

Ref.:	Diámetro	Perímetro 1,5	Perímetro 1,5 + luz ambiente
E720	Ø60	229	377
	Ø80	286	450
	Ø100	352	531

• Perfil negro de 1,5 cm. pintado bajo el cristal.



+80€



+70€

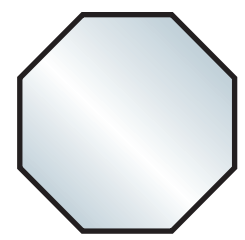

Ø 600 / 800 / 1000



15



rectangular

Ref.:	Ancho	Alto	Perímetro 1,5	Perímetro 1,5 + luz ambiente
E750	80	80	210	375
	90	80	222	408
	100	80	230	436
	120	80	256	487

• Perfil negro de 1,5 cm. pintado bajo el cristal.



+80€



+70€



800

800 / 900 / 1000 / 1200



15



COLECCIÓN
FORMS



+70€



POSICIÓN
HORIZONTAL
E760

always

Ref.:	Ancho	Alto	Sin bisel	Sin bisel + luz ambiente
E761	50	80	198	390
	60	100	224	428
	80	120	263	551

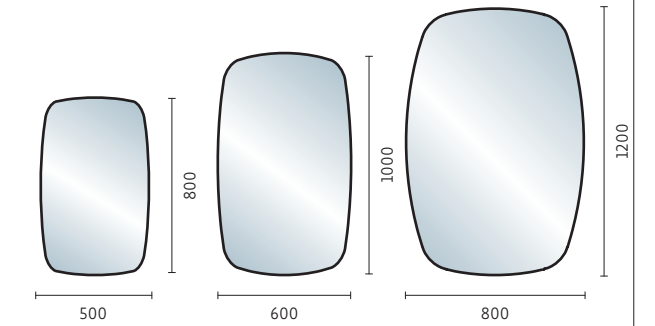

always body

Ref.:	Ancho	Alto	Sin bisel	Sin bisel + luz ambiente
E191	40	140	238	468
	35	180	269	514
	45	180	316	661

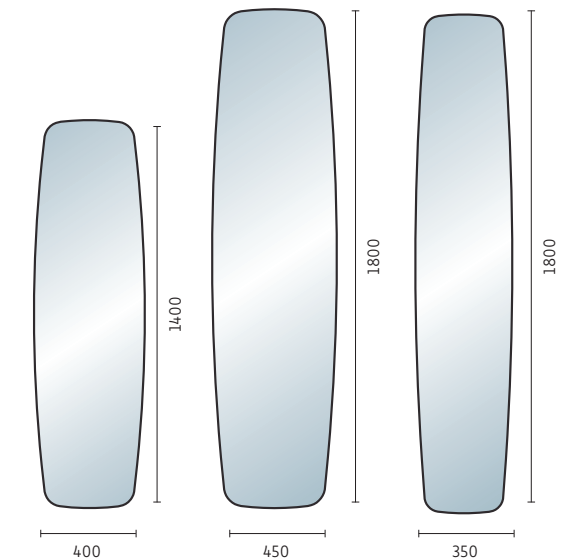

new naya body

Ref.:	Ancho	Alto	Sin bisel	Sin bisel + luz ambiente
E281	40	140	228	458
	35	180	254	499
	45	180	296	641

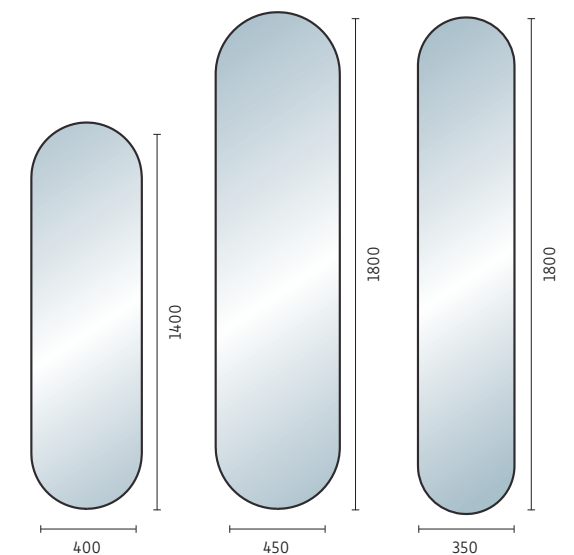

moon sin bisel

Ref.:	Diámetro	Sin bisel	Sin bisel + luz ambiente
E590	Ø60	200	408
	Ø70	212	422
	Ø80	220	438
	Ø90	247	451
	Ø100	271	471
	Ø110	325	530

+70€

rise sin bisel

Ref.:	Ancho	Alto	Sin bisel	Sin bisel + luz ambiente
E790	100	80	221	396
	110	90	239	435
	120	100	261	480

+70€

· Corte horizontal en la parte inferior ideal para completarlo con repisa barandilla F17, ver pág 53.

POSICIÓN VERTICAL E791 REVERSIBLE

moon bisel 3

Ref.:	Diámetro	Bisel 3	Bisel 3 + luz ambiente
E330	Ø80	287	474
	Ø90	314	504
	Ø100	336	572
	Ø110	383	611

+70€

Detalle bisel.

elliptic bisel 0,5

Ref.:	Ancho	Alto	Bisel 0,5	Bisel 0,5 + luz ambiente
E320	90	60	226	481
	105	70	279	524

+70€

Detalle bisel.

POSICIÓN VERTICAL E321

rock 21 sin bisel

Ref.:	Ancho	Alto	Sin bisel	Sin bisel + luz ambiente
E850	35	34	122	322
	75	73	195	383
	95	92	220	428

+70€

sail bisel 0,5

Ref.:	Ancho	Alto	Bisel 0,5	Bisel 0,5 + luz ambiente
E380	65	90	245	472

+70€

Detalle bisel.

POSICIÓN HORIZONTAL E381



COLECCIÓN
PENDENT



nubia

Ref.:	Diámetro	Fondo	Iluminación	PVP
E810	Ø60	4	no	468
	Ø70	4	no	496
E860	Ø60	4	si	646
	Ø70	4	si	689

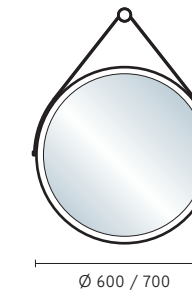
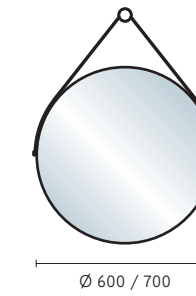

india

Ref.:	Ancho	Alto	Perfil	PVP
E650	60	90	2x2	763

- Espejo 2 caras con SEGURGLASS.
- Sólo válido para techo forjado.
- Tornillería no incluida

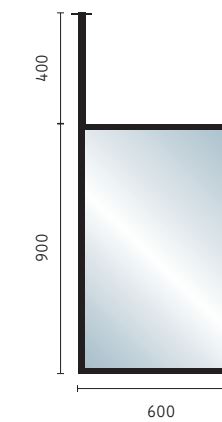

new nadia

Ref.:	Ancho	Alto	Perfil	PVP
E200	50	90	3	795

- Espejo 2 caras con SEGURGLASS.
- Sólo válido para techo forjado.
- Tornillería no incluida

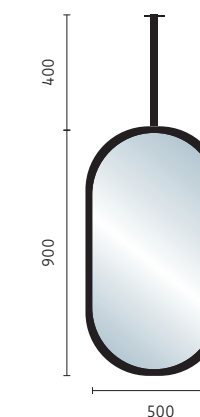



indra led arenado vertical

Ref.:	E530	E210
Medida hasta	Arenado	Arenado+ Retroiluminado
70x80	635	825
80x80	657	847
90x80	696	886
100x80	728	918
120x80	859	1049
140x80	950	1140

- +10% x10
- +70€
- +110€

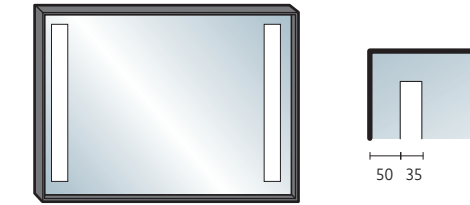

indra led arenado superior

Ref.:	E540	E220
Medida hasta	Arenado	Arenado+ Retroiluminado
70x80	653	843
80x80	691	881
90x80	720	910
100x80	754	944
120x80	784	974
140x80	862	1052

- +10% x10
- +70€
- +110€



indra led arenado perimetral

Ref.:	Ancho hasta	Alto hasta	Fondo 5
E550	70	80	631
	80	80	646
	90	80	672
	100	80	696
	120	80	730
	140	80	790

- +10% x10
- +70€
- +110€



indra

Ref.:	E500	E230		
Medida hasta	Fondo 3	Fondo 5	Retroilum. Fondo 3	Retroilum. Fondo 5
70x80	443	464	633	654
80x80	458	483	648	673
90x80	474	506	664	696
100x80	489	518	679	708
120x80	515	531	705	721
140x80	540	575	730	765

- +10% x10
- +70€



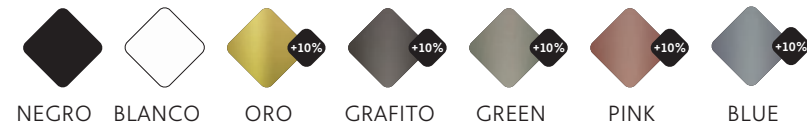

uma

Ref.:	Diámetro	Fondo 3	Fondo 5
E510	Ø80	406	419
	Ø90	468	477
	Ø100	-	519



+70€

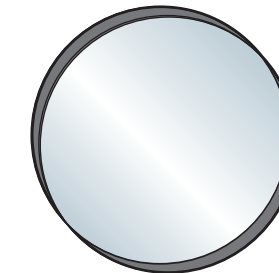

Ø 800 / 900 / 1000



new naya led arenado deco

Ref.:	Ancho	Alto	Fondo 5
E240	50	90	539

• Reversible en vertical.



+110€

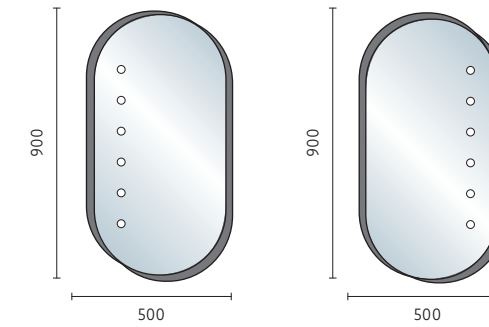

uma led arenado perimetral

Ref.:	Diámetro	Fondo 5
E560	Ø80	791
	Ø90	883
	Ø100	985



+70€



+110€

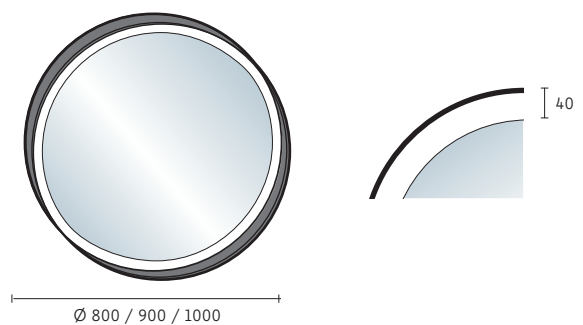

Ø 800 / 900 / 1000



new naya

Ref.:	Ancho	Alto	Fondo 3	Fondo 5
E910	50	90	443	461



POSICIÓN HORIZONTAL E911

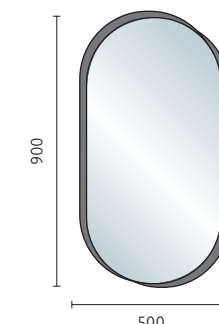

COLECCIÓN
CONTOUR



aura

Ref.:	E420		E600	
Diámetro	Perímetro 3 transparente	Perímetro 3 transp.+luz	Perímetro 4 arenado	Perímetro 4 arenado+luz
Ø80	314	542	283	513
Ø90	341	554	297	535
Ø100	362	586	328	553
Ø110	427	654	386	605

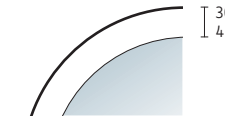
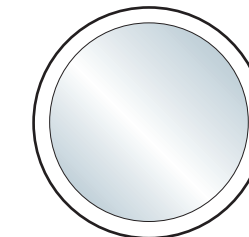

PERÍMETRO ARENADO.

shine

Ref.:	E430		E610	
Medida hasta	Perímetro 3 transparente	Perímetro 3 transp.+luz	Perímetro 4 arenado	Perímetro 4 arenado+luz
80 x 80	304	542	289	520
90 x 80	325	566	314	547
100 x 80	335	587	323	562
120 x 80	390	631	376	597
140 x 80	435	691	415	642



POSICIÓN VERTICAL E431 / E611

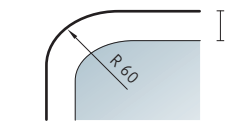
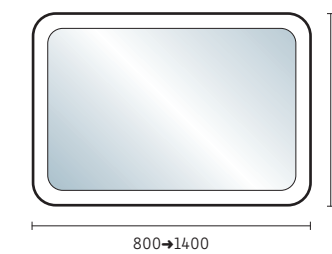

PERÍMETRO TRANSPARENTE.

bright

Ref.:	E440		E620	
Medida hasta	Perímetro 3 transparente	Perímetro 3 transp.+luz	Perímetro 4 arenado	Perímetro 4 arenado+luz
80 x 80	224	441	218	429
90 x 80	241	455	234	443
100 x 80	252	470	245	456
120 x 80	289	495	280	480
140 x 80	317	528	308	513



POSICIÓN VERTICAL E441 / E621

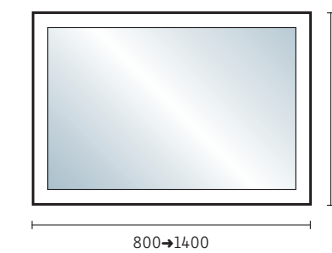

PERÍMETRO TRANSPARENTE.



COLECCIÓN
SAND



arenado superior

Ref.:	Ancho hasta	Alto hasta	Arenado superior
E390	60	80	386
	70	80	412
	80	80	426
	90	80	450
	100	80	471
	120	80	556
	140	80	625

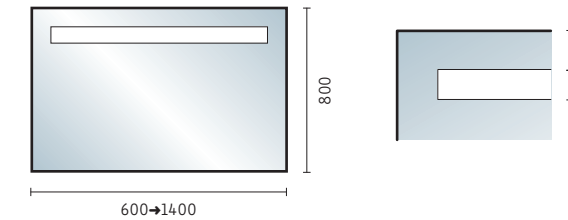

arenados verticales

Ref.:	Ancho hasta	Alto hasta	Arenados verticales
E400	60	80	463
	70	80	483
	80	80	511
	90	80	532
	100	80	558
	120	80	580
	140	80	637

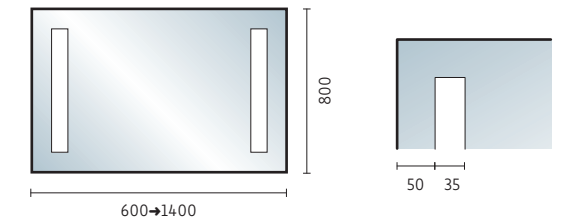

arenado marco 15

Ref.:	Ancho hasta	Alto hasta	Peímetro 15
E410	60	80	442
	70	80	457
	80	80	468
	90	80	486
	100	80	514
	120	80	538
	140	80	582

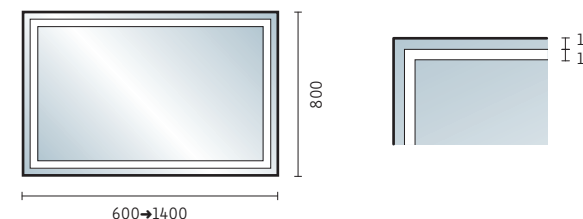

arenado marco 35

Ref.:	Ancho hasta	Alto hasta	Peímetro 35
E820	60	80	464
	70	80	481
	80	80	491
	90	80	511
	100	80	540
	120	80	565
	140	80	611

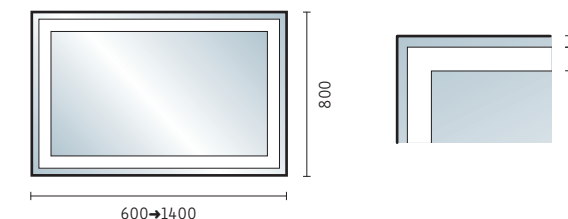

POSICIÓN VERTICAL E411



POSICIÓN VERTICAL E821



COLECCIÓN
COMBI



faja horizontal

Ref.:	Ancho hasta	Alto hasta	FANTASÍA	ARLUX	LACA SEL. MATE FENIX	MADERA
E02	60	80	194	224	282	387
	70	80	218	259	337	428
	80	80	225	257	347	461
	90	80	249	285	381	502
	100	80	264	305	419	552
	120	80	296	332	458	635
	140	80	356	397	539	756

- Sobre tablero de 2 cm.
- De no indicar lo contrario, anchura de la faja 8,5 cm.



luna centrada

Ref.:	Ancho hasta	Alto hasta	FANTASÍA	ARLUX	LACA SEL. MATE FENIX	MADERA
E010	60	80	194	224	282	387
	70	80	218	259	337	428
	80	80	225	257	347	461
	90	80	249	285	381	502
	100	80	264	305	419	552
	120	80	296	332	458	635
	140	80	356	397	539	756

- Sobre tablero de 2 cm.
- De no indicar lo contrario, anchura del marco 3 cm.

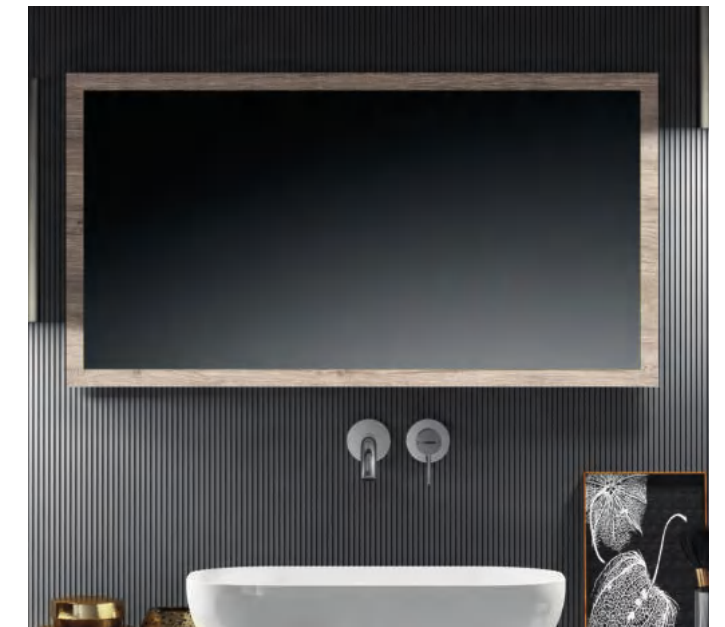
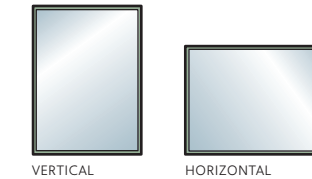

faja desplazada

Ref.:	Ancho hasta	Alto hasta	FANTASÍA	ARLUX	LACA SEL. MATE FENIX	MADERA
E050	60	80	194	224	282	387
	70	80	218	259	337	428
	80	80	225	257	347	461
	90	80	249	285	381	502
	100	80	264	305	419	552
	120	80	296	332	458	635
	140	80	356	397	539	756

- Sobre tablero de 2 cm.
- De no indicar lo contrario, anchura de la faja 8,5 cm.
- Indicar mano del desplazado.

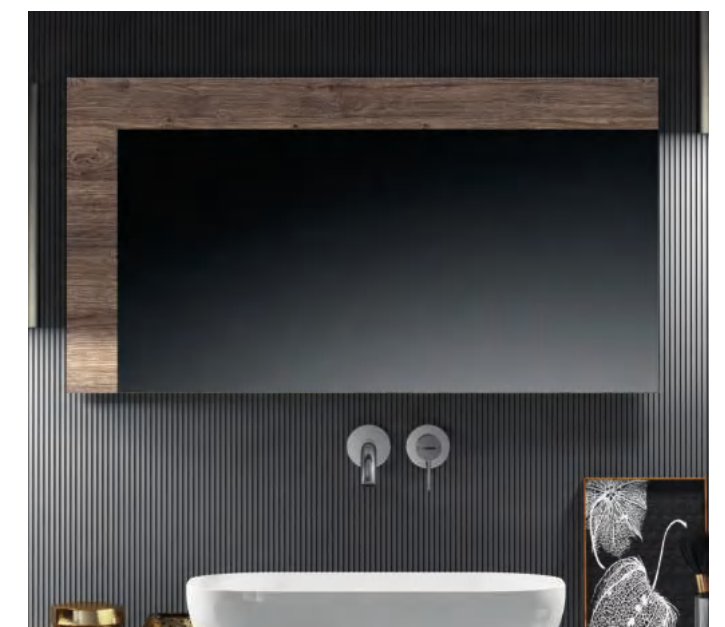

COLECCIÓN
LACK

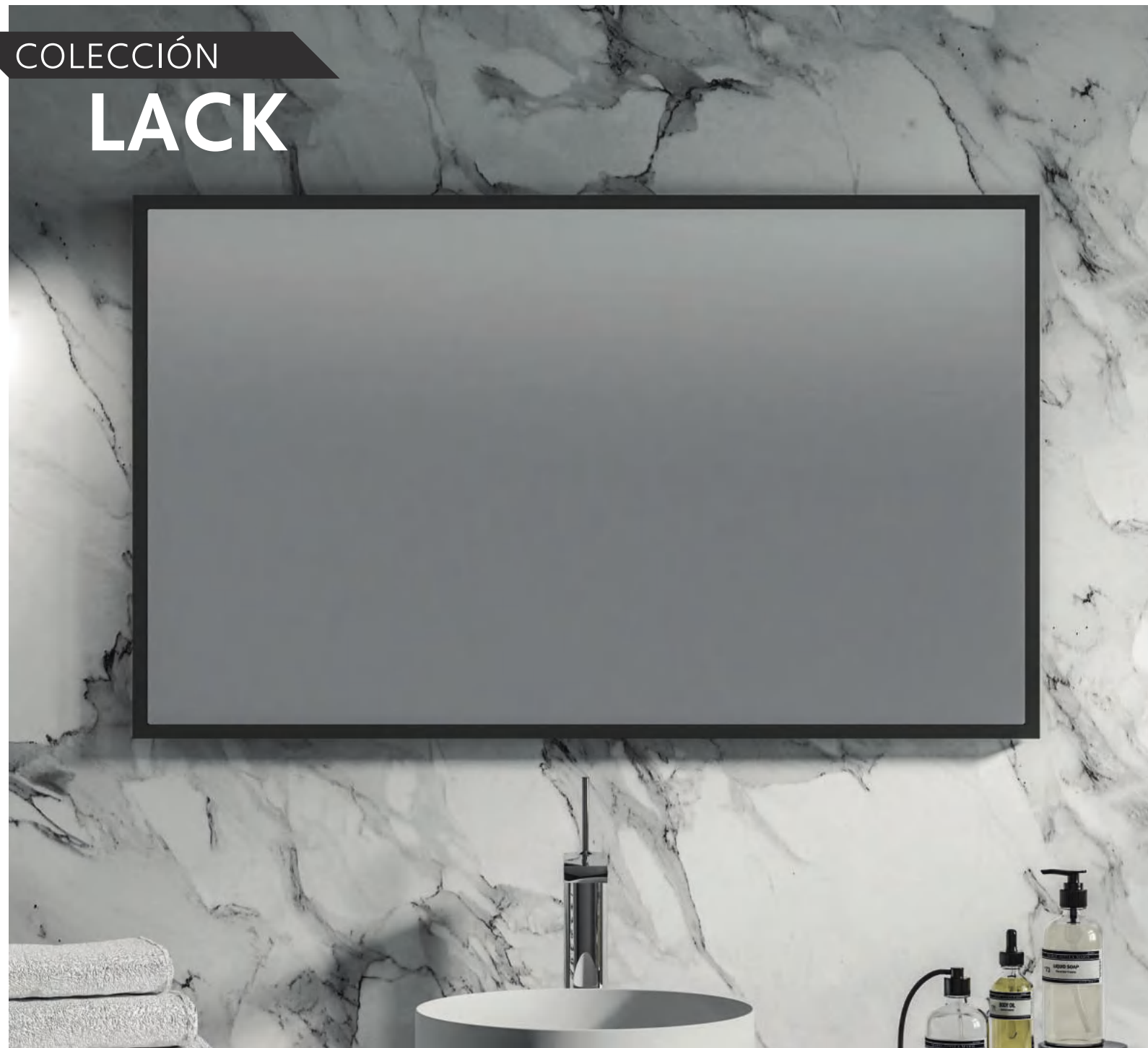

luna recta enrasada

Ref.:	Ancho hasta	Alto hasta	Laca Select Mate
E130	70	80	367
	80	80	389
	90	80	427
	100	80	468
	120	80	514
	140	80	605

- Enrasada al tablero de 2 cm.
- De no indicar lo contrario, anchura del marco 1,2 cm.

luna circular enrasada

Ref.:	Diámetro	Laca Select Mate
E12	Ø80	421
	Ø90	456
	Ø100	488

- Enrasada al tablero de 2 cm.
- De no indicar lo contrario, anchura del marco 1,2 cm.



COLECCIÓN
CLASSIC



+10% x10

+70€

+80€

POSICIÓN VERTICAL E451

luna lisa

LUZ AMBIENTE TOTAL

Ref.:	Ancho hasta	Alto hasta	Luz ambiente total
E450	70	80	351
	80	80	366
	90	80	390
	100	80	419
	120	80	451
140	80	507	

• Opción espejo aumento integrado se suministra de Ø18 cm. a la derecha, centrado en altura y a 10 cm. del borde.

SOLO UNA OPCIÓN

+90€

+155€

+295€

+110€

+10% x10

+70€

+80€

POSICIÓN VERTICAL E671

luna lisa

LUZ AMBIENTE SUPERIOR/INFERIOR

Ref.:	Ancho hasta	Alto hasta	Luz ambiente superior e inferior
E670	70	80	324
	80	80	347
	90	80	362
	100	80	385
	120	80	413
140	80	446	

• Opción espejo aumento integrado se suministra de Ø18 cm. a la derecha, centrado en altura y a 10 cm. del borde.

SOLO UNA OPCIÓN

+90€

+155€

+295€

+110€

+10% x10

+70€

POSICIÓN VERTICAL E071

luna lisa

TRASERA REMETIDA

Ref.:	Ancho hasta	Alto hasta	Trasera remetida
E070	70	80	198
	80	80	215
	90	80	239
	100	80	257
	120	80	288
140	80	340	

• Trasera acabado marengo y canto color aluminio, remetida 3 cm.
• Opción espejo aumento integrado se suministra de Ø18 cm. a la derecha, centrado en altura y a 10 cm. del borde.

SOLO UNA OPCIÓN

+90€

+155€

+295€

+10% x10

+70€

POSICIÓN VERTICAL E031

luna lisa

CON TRASERA

Ref.:	Ancho hasta	Alto hasta	Con trasera
E030	70	80	194
	80	80	209
	90	80	233
	100	80	251
	120	80	282
140	80	330	

• Trasera acabado marengo y canto color aluminio.
• Opción espejo aumento integrado se suministra de Ø18 cm. a la derecha, centrado en altura y a 10 cm. del borde.

SOLO UNA OPCIÓN

+90€

+155€

+295€

+10% x10

+70€

POSICIÓN VERTICAL E041

luna lisa

SIN TRASERA

Ref.:	Ancho hasta	Alto hasta	Sin trasera
E040	70	80	153
	80	80	166
	90	80	176
	100	80	185
120	80	211	

• Opción espejo aumento integrado se suministra de Ø18 cm. a la derecha, centrado en altura y a 10 cm. del borde.

SOLO UNA OPCIÓN

+90€

+155€





+10% x10

+70€

+80€

POSICIÓN VERTICAL E461

luna bisel 0,5

LUZ AMBIENTE TOTAL

Ref.:	Ancho hasta	Alto hasta	Luz ambiente total
E460	70	80	374
	80	80	394
	90	80	419
	100	80	439
	120	80	476
140	80	535	

• Opción espejo aumento integrado se suministra de Ø18 cm. a la derecha, centrado en altura y a 10 cm. del borde.

SOLO UNA OPCIÓN

+90€

+155€

+295€

+110€

+10% x10

+70€

+80€

POSICIÓN VERTICAL E681

luna bisel 0,5

LUZ AMBIENTE SUPERIOR/INFERIOR

Ref.:	Ancho hasta	Alto hasta	Luz ambiente superior e inferior
E680	70	80	363
	80	80	383
	90	80	406
	100	80	426
	120	80	462
140	80	519	

• Opción espejo aumento integrado se suministra de Ø18 cm. a la derecha, centrado en altura y a 10 cm. del borde.

SOLO UNA OPCIÓN

+90€

+155€

+295€

+110€

+10% x10

+70€

POSICIÓN VERTICAL E151

luna bisel 0,5

CON TRASERA

Ref.:	Ancho hasta	Alto hasta	Con trasera
E150	70	80	209
	80	80	218
	90	80	241
	100	80	260
	120	80	290
140	80	338	

• Trasera acabado Marengo y canto color aluminio.

• Opción espejo aumento integrado se suministra de Ø18 cm. a la derecha, centrado en altura y a 10 cm. del borde.

SOLO UNA OPCIÓN

+90€

+155€

+295€

+10% x10

+70€

POSICIÓN VERTICAL E141

luna bisel 0,5

SIN TRASERA

Ref.:	Ancho hasta	Alto hasta	Sin trasera
E140	70	80	171
	80	80	185
	90	80	200
	100	80	210
120	80	237	

• Opción espejo aumento integrado se suministra de Ø18 cm. a la derecha, centrado en altura y a 10 cm. del borde.

SOLO UNA OPCIÓN

+90€

+155€





**standard
CON LUZ**

Ref.:	Ancho	Alto	Con luz
E260	60	80	230
	70	80	252
	80	80	257
	90	80	285
	100	80	295
	120	80	330

- Posibilidad de girar 90° para posicionar horizontal o vertical.
- Disponible solo 4000°K.

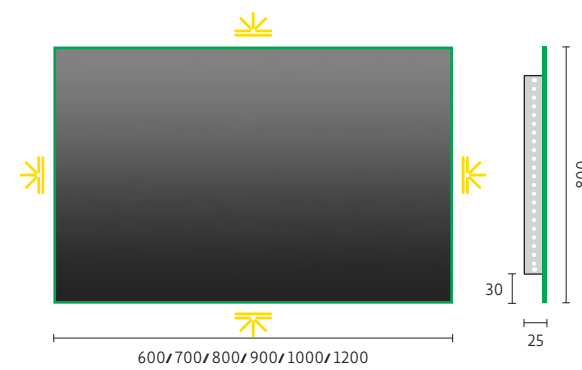

**standard
SIN TRASERA**

Ref.:	Ancho	Alto	Sin trasera
E270	60	80	84
	70	80	95
	80	80	111
	90	80	117
	100	80	128
	120	80	157

- Posibilidad de girar 90° para posicionar horizontal o vertical.

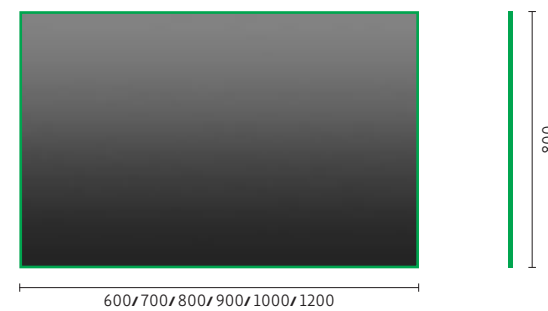

**cover
CON CORNISA**

Ref.:	Ancho hasta	Alto hasta	FANTASÍA	ARLUX	FENIX
E250	70	80	362	379	407
	80	80	383	399	428
	90	80	423	447	471
	100	80	454	485	504
	120	80	521	533	556
	140	80	597	609	634

- +10%x10
- +70€



POSICIÓN VERTICAL E251

TEMPERATURA 4000°K.

- Opción 2700°K sin incremento.
- Cornisa con tira led incluida
- Canto trasera mismo acabado que la cornisa.

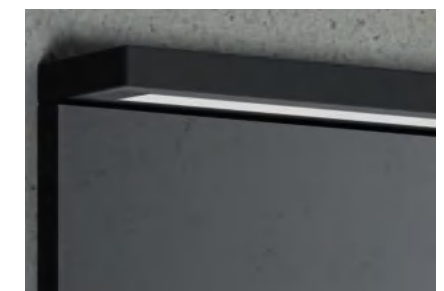
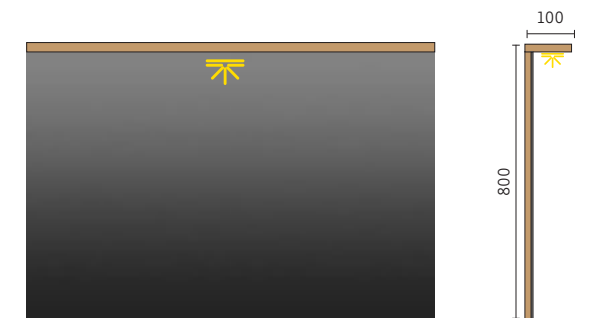

COLECCIÓN
DECO



loft horizontal luz ambiente

Ref.:	Ancho hasta	Alto hasta	Fondo	FANTASÍA	ARLUX	LACA SEL. MATE FENIX	MADERA
A34	80	80	13	422	484	596	663
	90	80	13	468	528	647	714
	100	80	13	521	582	699	762
	120	80	13	628	677	809	871

• Hueco fijo sin espejo 15 cm. Regulación superior visto.

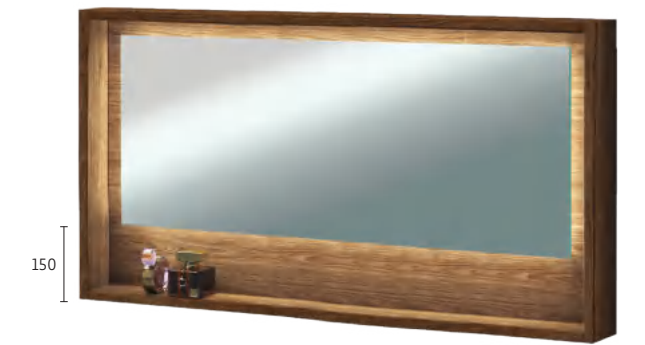

loft vertical luz ambiente

Ref.:	Ancho hasta	Alto hasta	Fondo	FANTASÍA	ARLUX	LACA SEL. MATE FENIX	MADERA
A24	60	90	13	463	513	577	650
	80	90	13	523	586	658	723

• Hueco fijo sin espejo 15 cm. Regulación superior visto.



espejo decorativo

Ref.:	Ancho hasta	Alto hasta	Fondo	FANTASÍA	ARLUX	LACA SEL. MATE FENIX	MADERA
A20	80	80	13	227	280	373	440
	90	80	13	245	301	396	462
	100	80	13	264	325	417	483
	120	80	13	319	367	436	498

• Regulación superior visto.



always capacity

Ref.:	Ancho	Alto	Fondo	FANTASÍA	ARLUX	LACA SEL. MATE FENIX	MADERA
A49	50	80	15→19	372	417	619	642

- Puerta espejo 4 mm con trasera, armazón rectangular, ver ficha técnica.
- Indicar mano.
- Opción iluminación interior con sensor, luz led ubicada en lado contrario a las bisagras.
- Baldas interiores cristal fume templado.

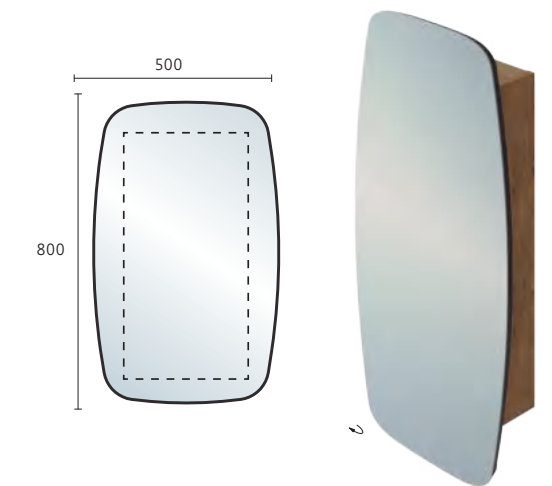

flat luz ambiente

Ref.:	Ancho hasta	Alto hasta	Fondo	FANTASÍA	ARLUX	LACA SEL. MATE FENIX	MADERA
A230	80	80	13	454	514	585	647
	90	80	13	499	559	632	693
	100	80	13	551	612	681	740
	120	80	13	658	708	783	840

• Regulación superior visto. Perímetro 3 cm.



new naya capacity

Ref.:	Ancho	Alto	Fondo	FANTASÍA	ARLUX	LACA SEL. MATE FENIX	MADERA
A40	50	90	15→19	372	417	619	642

- Puerta espejo 4 mm con trasera, armazón rectangular, ver ficha técnica.
- Indicar mano.
- Opción iluminación interior con sensor, luz led ubicada en lado contrario a las bisagras.
- Baldas interiores cristal fume templado.

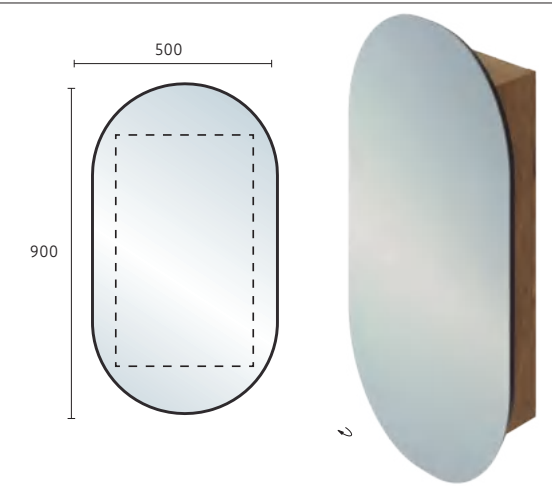

CAMERINOS PUERTA ESPEJO



IMAGEN REPRESENTADA CON OPCIÓN DE CORNISA CON LUZ INTEGRADA (VER SUPLEMENTO)

1 puerta

Ref.:	Ancho hasta	Alto hasta	Fondo hasta	FANTASÍA*	ARLUX*	LACA SEL. MATE FENIX	MADERA
A41	40	70	15→19	249	278	415	446
	50	70	15→19	271	304	459	491

- Indicar mano.
- Se suministra con puerta recta y base remetida.
- El fondo incluye el grosor de la puerta.

***OPCIÓN CORNISA CON LUZ INTEGRADA**

- Solo acabados fantasía y arlux.
- Medida de vuelo 8 cm.
- No disponible para composiciones modulares.
- Se suministra instalada.

2 puertas

Ref.:	Ancho hasta	Alto hasta	Fondo hasta	FANTASÍA*	ARLUX*	LACA SEL. MATE FENIX	MADERA
A42	70	70	15→19	353	397	597	639
	80	70	15→19	388	436	656	698
	90	70	15→19	428	481	728	773

- Se suministra con puertas rectas y base remetida.
- El fondo incluye el grosor de la puerta.

***OPCIÓN CORNISA CON LUZ INTEGRADA**

- Solo acabados fantasía y arlux.
- Medida de vuelo 8 cm.
- No disponible para composiciones modulares.
- Se suministra instalada.

2 puertas asimétrico

Ref.:	Ancho hasta	Alto hasta	Fondo hasta	FANTASÍA*	ARLUX*	LACA SEL. MATE FENIX	MADERA
A15	70	70	15→19	353	397	597	639
	80	70	15→19	388	436	656	698
	90	70	15→19	428	481	728	773

- Se suministra con puertas rectas y base remetida.
- El fondo incluye el grosor de la puerta.

***OPCIÓN CORNISA CON LUZ INTEGRADA**

- Solo acabados fantasía y arlux.
- Medida de vuelo 8 cm.
- No disponible para composiciones modulares.
- Se suministra instalada.

3 puertas asimétrico

Ref.:	Ancho hasta	Alto hasta	Fondo hasta	FANTASÍA*	ARLUX*	LACA SEL. MATE FENIX	MADERA
A17	80	70	15→19	426	471	687	744
	100	70	15→19	468	509	761	811
	120	70	15→19	495	545	821	911

- Se suministra con puertas rectas y base remetida.
- El fondo incluye el grosor de la puerta.

***OPCIÓN CORNISA CON LUZ INTEGRADA**

- Solo acabados fantasía y arlux.
- Medida de vuelo 8 cm.
- No disponible para composiciones modulares.
- Se suministra instalada.

3 puertas tríptico

Ref.:	Ancho hasta	Alto hasta	Fondo hasta	FANTASÍA*	ARLUX*	LACA SEL. MATE FENIX	MADERA
A46	80	70	15→19	440	485	700	789
	100	70	15→19	483	521	780	870
	120	70	15→19	510	560	836	932

- Se suministra con puertas rectas y base remetida.
- El fondo incluye el grosor de la puerta.

***OPCIÓN CORNISA CON LUZ INTEGRADA**

- Solo acabados fantasía y arlux.
- Medida de vuelo 8 cm.
- No disponible para composiciones modulares.
- Se suministra instalada.



CAMERINOS DOBLE ESPEJO



1 puerta

Ref.:	Ancho hasta	Alto hasta	Fondo	PVP
A50	40	70	15→19	533
	50	70	15→19	582

- Indicar mano.
- Se suministra con puerta recta y base remetida.
- El fondo incluye el grosor de la puerta.

2 puertas

Ref.:	Ancho hasta	Alto hasta	Fondo	PVP
A53	70	70	15→19	806
	80	70	15→19	883
	90	70	15→19	939

- Se suministra con puertas rectas y base remetida.
- El fondo incluye el grosor de la puerta.

2 puertas asimétrico

Ref.:	Ancho hasta	Alto hasta	Fondo	PVP
A51	70	70	15→19	799
	80	70	15→19	875
	90	70	15→19	930

- Se suministra con puertas rectas y base remetida.
- El fondo incluye el grosor de la puerta.

70

40 30

80

50 30

90

55 35

3 puertas

Ref.:	Ancho hasta	Alto hasta	Fondo	PVP
A54	80	70	15→19	996
	100	70	15→19	1105
	120	70	15→19	1177

- Se suministra con puertas rectas y base remetida.
- El fondo incluye el grosor de la puerta.

3 puertas asimétrico

Ref.:	Ancho hasta	Alto hasta	Fondo	PVP
A52	80	70	15→19	996
	100	70	15→19	1105
	120	70	15→19	1177

- Se suministra con puertas rectas y base remetida.
- El fondo incluye el grosor de la puerta.

80

22 36 22

100

27 46 27

120

35 50 35



ILUMINACIÓN



tube durian®

Ref.:	Alto	Diámetro	Durian®	Negro	Oro
901100001XX	25	Ø7	137	265	292

• Cable blanco de 1,5 metros.

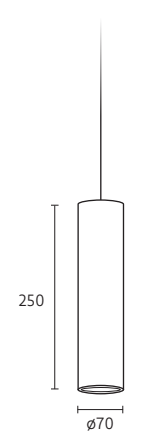

ceiling metallic

Ref.:	Alto	Diámetro	Blanco	Negro	Oro
Q20	25	Ø6	163	163	179

• Acero semi pulido.
• Cable negro de 1 metro.

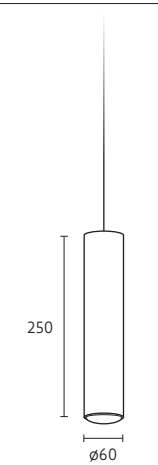

victoria metallic

Ref.:	Alto	Diámetro	Blanco	Negro	Met.
Q21	28	Ø4,5	127	127	140

• Acero semi pulido.
• Se suministra sin bombilla. Cable negro de 1m.
• Componentes con IP65.

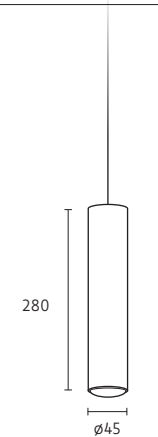
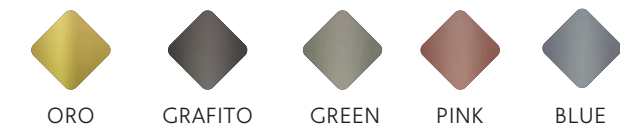

ebro

Ref.:	Ancho	Fondo	W	°K	Lumen	Cromo
Q10	28	11	6	5700°	457	105
	49	11	8	5700°	568	125
	49	11	8	4000°	568	125
	80	11	10	5700°	791	170
	100	11	15	5700°	1265	205
	120	11	18	5700°	1532	235

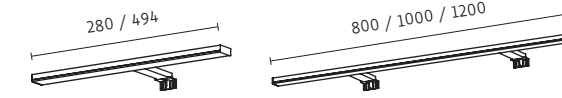

ebro negro

Ref.:	Ancho	Fondo	W	°K	Lumen	Negro
Q101	30	11	7	5700°	457	125
	50	11	9	5700°	568	145

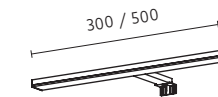

narcea

Ref.:	Ancho	Fondo	W	°K	Lumen	PVP
Q06	30	11	7	5700°	599	80
	50	11	9	5700°	648	97
	80	11	12	5700°	1169	138



bidasoa

Ref.:	Ancho	Fondo	W	°K	Lumen	PVP
Q07	30	11	7	4000°	637	93
	50	11	9	4000°	919	120
	80	11	10	4000°	1052	165

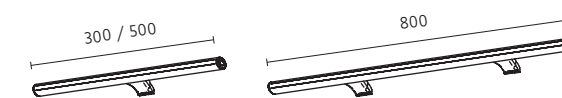

08.

ENCIMERAS Y LAVABOS

PIVSTONE p.130

DURIAN p.136

CERAMIC p.162





PIVSTONE

TECNOLOGÍA PIUTECH

ES UN RECUBRIMIENTO TRANSPARENTE APLICADO A LAS ENCIMERAS DE PIVSTONE® QUE CIERRA LOS POROS DE LA SUPERFICIE, DOTÁNDOLA DE UNA GRAN SOLIDEZ Y RESISTENCIA CONTRA LOS AGENTES EXTERNOS SIN ALTERAR LAS PROPIEDADES, LA ELEGANCIA Y EL ESTILO DE LA PIEDRA NATURAL.

RIGUROSOS CONTROLES DE CALIDAD VERIFICAN Y COMPRUEBAN HASTA EL MÁS MÍNIMO DETALLE DEL PROCESO DE PRODUCCIÓN.



CONFIGURACIÓN DE ENCIMERA

1	2	3	4	5	6
MEDIDAS	UBICACIÓN LAVABOS	POSICIÓN GRIFERÍA	MEDIDA SENO	GROSOR FALDÓN	ACABADOS
M1 Fondo	M3 Desplazamiento		1 45x27 2 60x27 9 A medida máximo 1 metro (consultar precio)	1,2 cm. PORCELÁNICO	
M2 Ancho				2 cm. MÁRMOL PIUTECH	
M4 Meseta trasera				4-8 cm. PORCELÁNICO MÁRMOL PIUTECH	
M5 Distancia desagüe				8,1-18 cm. PORCELÁNICO MÁRMOL PIUTECH	
M6 Meseta delantera					
G1 Ángulo pared lateral					
G2 Ángulo pared lateral					

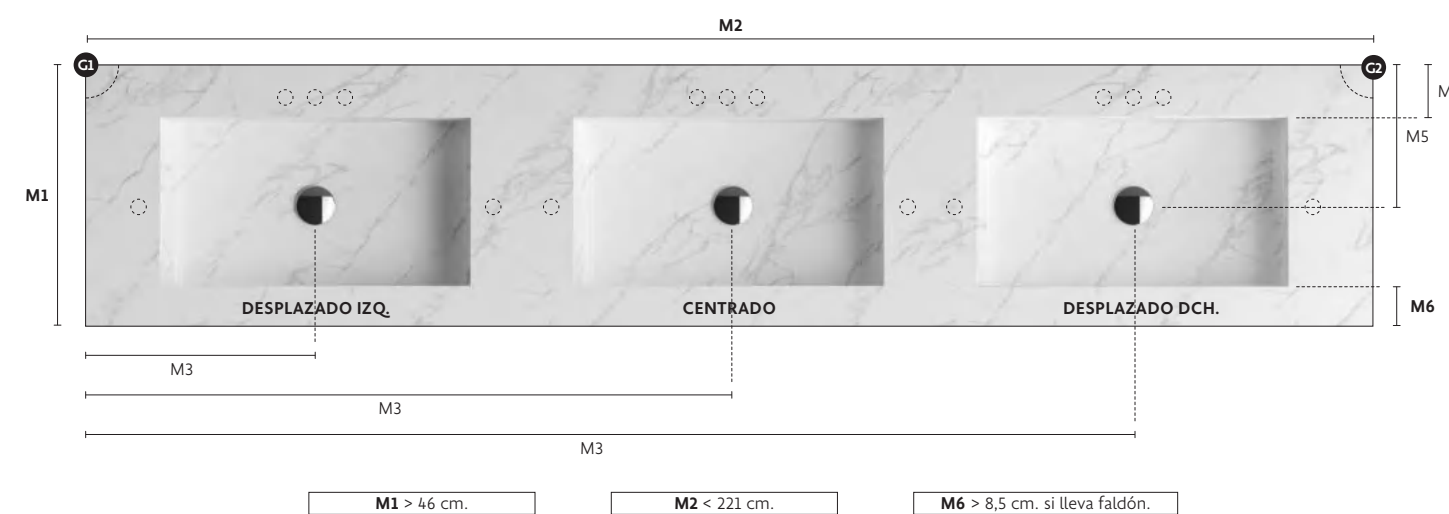

• En encimeras superiores a 90 cm. sobre mobiliario, es necesario instalar escuadras de refuerzo.

ACABADOS

mármol piutech GROSOR 20-180

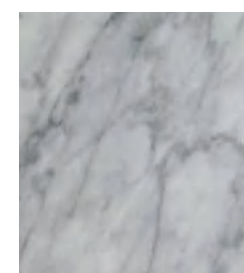

M01 CARRARA

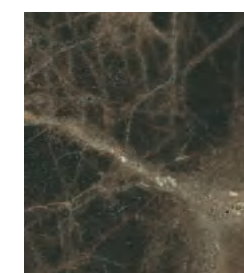

M04 DARK EMPERADOR

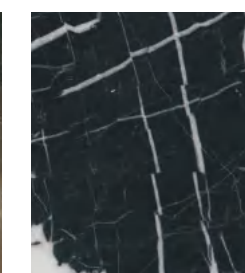

M05 NEGRO MARQUINA

compact piutech GROSOR 20-180



C01 CALACATTA

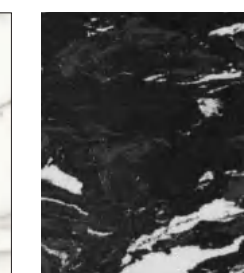

C04 NEGRO MARQUINA

porcelánico GROSOR 12-180

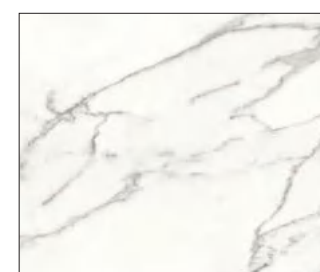

P01 CALACATTA

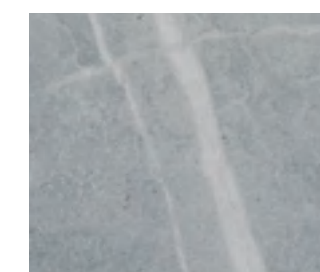

P02 ZAHA STONE

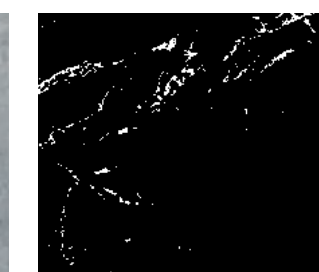

P04 NEGRO MARQUINA



P05 BASALT BLACK



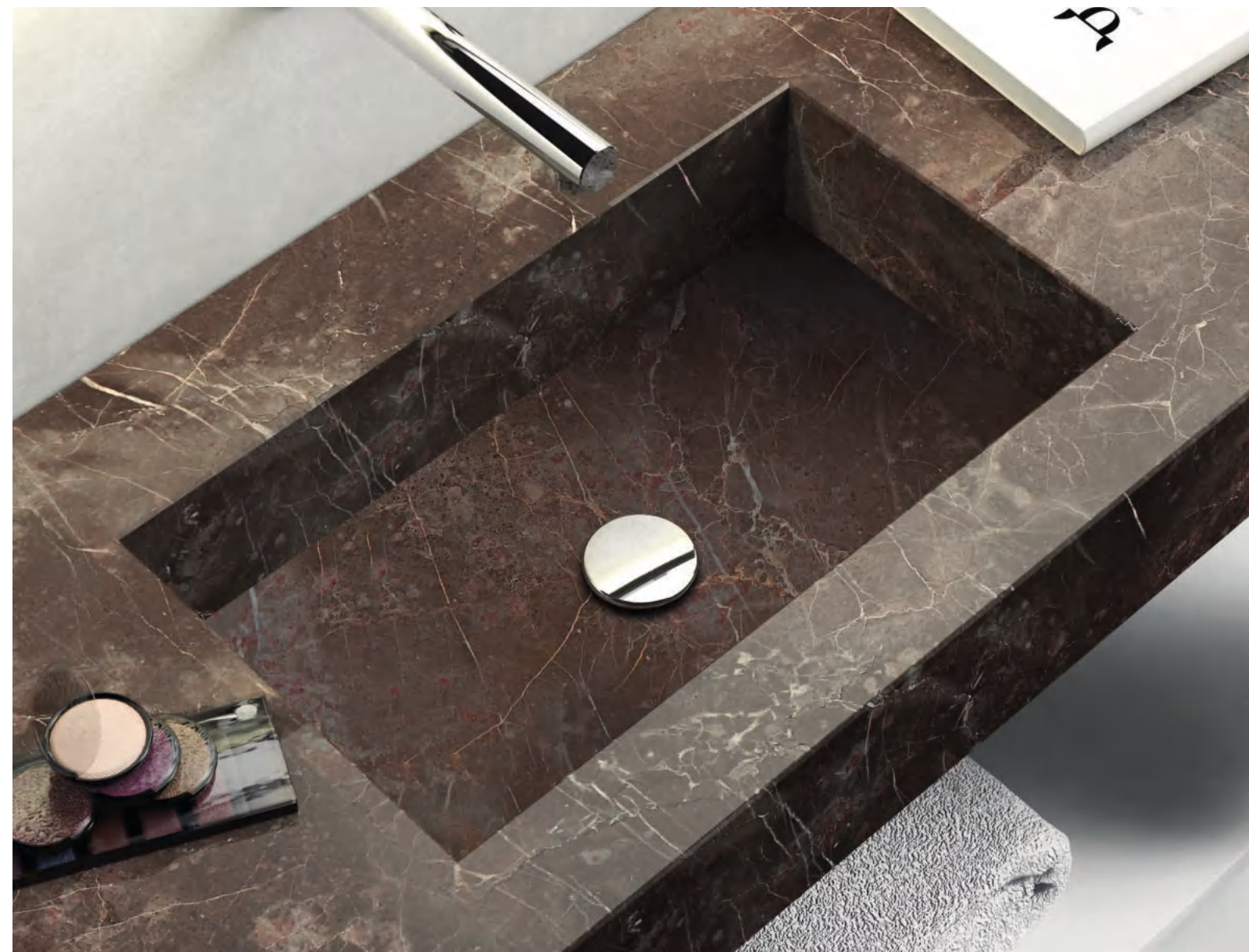

DARK EMPERADOR



ZAHA STONE

PIVSTONE MYKONOS

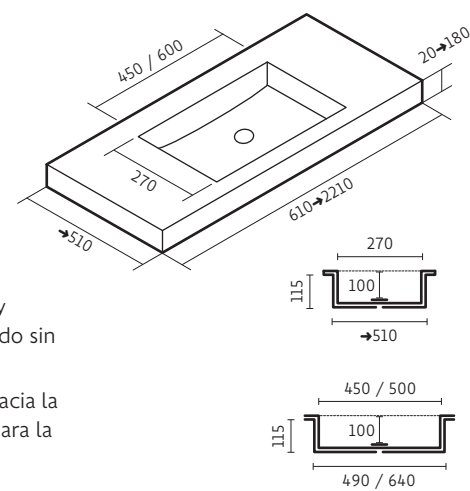

El Mármol Piutech permite que lavabo y encimera se integran en un único acabado sin que se aprecien uniones.

Se ha diseñado una caída redondeada hacia la válvula clicker en el fondo del lavabo, para la perfecta evacuación del agua.

MÁRMOL PIUTECH

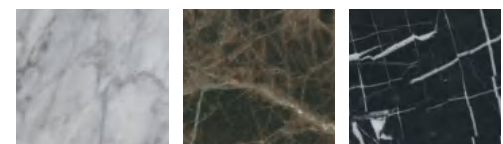

M01 CARRARA M04 DARK EMPERADOR M05 NEGRO MARQUINA

COMPACT PIUTECH



C01 CALACATTA C04 NEGRO MARQUINA

Referencia	Ancho hasta
101SFM061AAA	61
101SFM071AAA	71
101SFM081AAA	81
101SFM091AAA	91
101SFM101AAA	101
101SFM111AAA	111
101SFM121AAA	121
101SFM131AAA	131
101SFM141AAA	141
101SFM151AAA	151
101SFM161AAA	161
101SFM171AAA	171
101SFM181AAA	181
101SFM191AAA	191
101SFM201AAA	201
101SFM211AAA	211
101SFM221AAA	221

• Rebosadero no disponible.

MÁRMOL/COMPACT

Grosor 2	Grosor 4-8	Grosor 8,1-18
1.099	1.370	1.573
1.162	1.466	1.678
1.225	1.562	1.783
1.288	1.658	1.888
1.361	1.754	1.993
1.424	1.849	2.089
1.487	1.945	2.194
1.550	2.041	2.299
1.613	2.137	2.404
1.676	2.233	2.509
1.740	2.319	2.614
1.803	2.415	2.719
1.866	2.511	2.824
1.929	2.607	2.929
2.002	2.702	3.034
2.065	2.798	3.130
2.128	2.894	3.235

• Lavabo 60 cm. + 240€

PIVSTONE THAIS

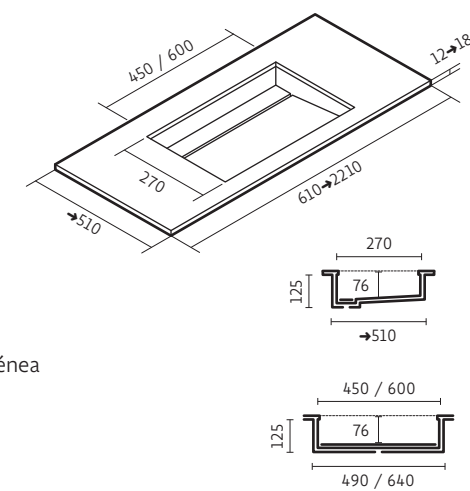

Los materiales porcelánicos poseen cualidades únicas; gran variedad de espesores (desde 1,2 cm.), veta homogénea y ausencia de porosidad.

PORCELÁNICO



P01 CALACATTA P02 ZAHA STONE P04 NEGRO MARQUINA P05 BASALT BLACK

Referencia	Ancho hasta
151SFM061AAA	61
151SFM071AAA	71
151SFM081AAA	81
151SFM091AAA	91
151SFM101AAA	101
151SFM111AAA	111
151SFM121AAA	121
151SFM131AAA	131
151SFM141AAA	141
151SFM151AAA	151
151SFM161AAA	161
151SFM171AAA	171
151SFM181AAA	181
151SFM191AAA	191
151SFM201AAA	201
151SFM211AAA	211
151SFM221AAA	221

• Rebosadero no disponible.

PORCELÁNICO

Grosor 1,2	Grosor 4-8	Grosor 8,1-18
1.527	1.912	2.247
1.621	2.049	2.399
1.714	2.185	2.551
1.807	2.322	2.703
1.916	2.458	2.855
2.009	2.595	2.992
2.102	2.732	3.143
2.196	2.868	3.295
2.289	3.005	3.447
2.382	3.142	3.599
2.476	3.263	3.751
2.569	3.400	3.903
2.662	3.536	4.055
2.756	3.673	4.206
2.864	3.809	4.358
2.957	3.946	4.495
3.051	4.083	4.647

• Lavabo 60 cm. + 310€





NEGRO MARQUINA

PIVSTONE ENCIMERAS SIN LAVABO



Las encimeras PIVSTONE® son fácilmente combinables con cualquier lavabo sobre encimera.

Es necesario adjuntar la ficha técnica de dicho lavabo para el preciso mecanizado de sifones y grifería.

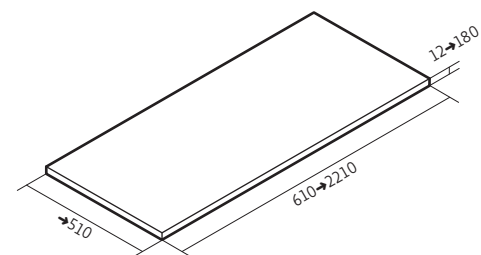

Referencia	Ancho hasta
200SFM061AAA	61
200SFM071AAA	71
200SFM081AAA	81
200SFM091AAA	91
200SFM101AAA	101
200SFM111AAA	111
200SFM121AAA	121
200SFM131AAA	131
200SFM141AAA	141
200SFM151AAA	151
200SFM161AAA	161
200SFM171AAA	171
200SFM181AAA	181
200SFM191AAA	191
200SFM201AAA	201
200SFM211AAA	211
200SFM221AAA	221

MÁRMOL/COMPACT

Grosor 2	Grosor 4→8	Grosor 8,1→18
421	706	931
489	808	1.043
557	910	1.155
625	1.012	1.267
704	1.113	1.379
772	1.215	1.481
840	1.317	1.593
908	1.419	1.704
976	1.520	1.816
1.044	1.622	1.928
1.112	1.714	2.040
1.180	1.815	2.152
1.249	1.917	2.264
1.317	2.019	2.376
1.395	2.121	2.488
1.463	2.222	2.590
1.531	2.324	2.702

PORCELÁNICO

Grosor 1,2	Grosor 4→8	Grosor 8,1→18
614	1.015	1.377
713	1.159	1.537
812	1.302	1.697
911	1.446	1.857
1.027	1.590	2.017
1.126	1.734	2.161
1.226	1.877	2.321
1.325	2.021	2.495
1.424	2.165	2.642
1.523	2.309	2.802
1.623	2.436	2.962
1.722	2.580	3.122
1.821	2.724	3.282
1.920	2.867	3.442
2.036	3.011	3.603
2.135	3.155	3.746
2.234	3.299	3.907

• Rebosadero no disponible. Calado de encimera otros fabricantes +90€.

ACCESORIOS

copete recto

Ref.:	Alto hasta	Mármol / Compact	Porcel.
20501X100AAA	8	245	447
20501X100AAA	30	277	613

- Mínimo facturable 1 metro.
- Precio por metro lineal.

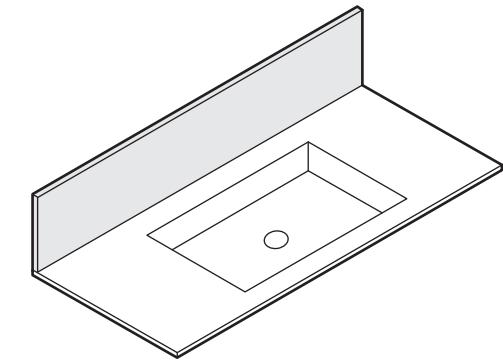

toalleros

Ref.:	Modelo	Ancho	PVP
98002M050101	Superior	30→50	150
98003M050101	Frontal	30→50	150

- Toallero superior vuelo mínimo 8 cm. (3+4+1).
- Toallero frontal se suministra centrado en altura.

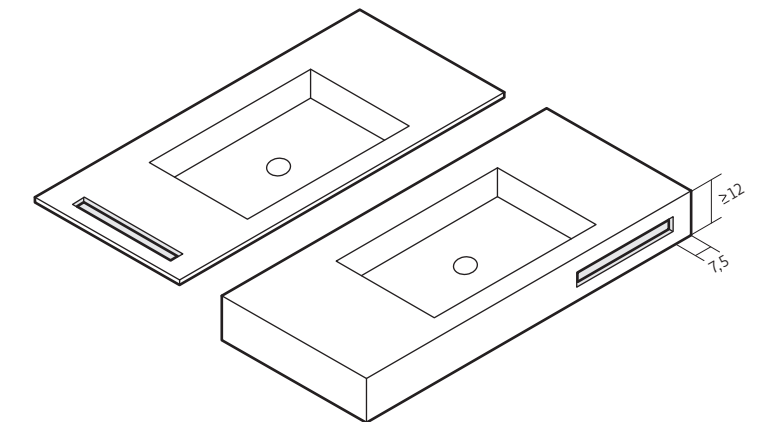

escuadra invisible

Ref.:	Unidades	Fondo	Acero inox
P160NN026	2	26	90
P160NN041	2	41	105
P170NN026	3	26	140
P170NN041	3	41	160

- En encimeras superiores a 90 cm. sobre mobiliario, es necesario instalar escuadras de refuerzo.
- Tornillería no incluida

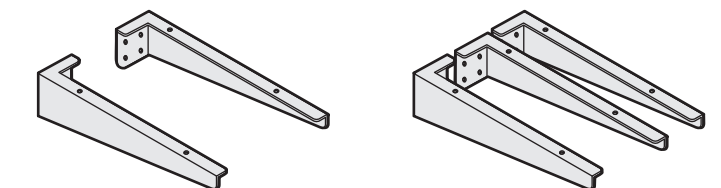

segundo lavabo

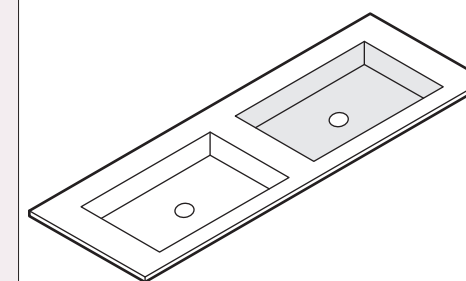

45	+ 800 €
60	+ 1100 €

segundo orificio

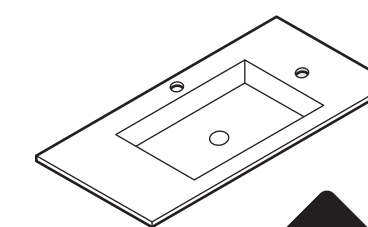

+45€

cortes rectos

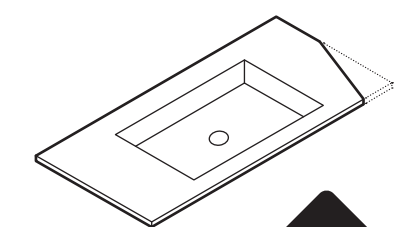

+75€



durian®

Durian® es una marca registrada de Solid Surface fabricada por KYRYA® group, que cuenta con todas las certificaciones de calidad.

El componente principal es un mineral (Trihidrato de Alúmina) que mezclado con un bajo porcentaje de resinas hacen que nuestro producto sea inyectable en moldes para conseguir las formas deseadas. Se presenta en su color natural blanco neutro, tiene un tacto agradable, similar al mineral compacto, de gran dureza, alta resistencia al impacto y permite la construcción de espacios sin uniones visibles, siendo homogéneo y sólido en todo su espesor.

Durian® representa la personalidad, la elegancia y la creatividad de unos materiales que brindan la posibilidad de cualquier estilo en el diseño.



GRAN CALIDAD



MOLDEABLE



HIGIÉNICO



ECOLÓGICO



REPARABLE



LIMPIO Y DURADERO

MEDIDAS NECESARIAS PARA CONFIGURAR UNA ENCIMERA

Para la correcta configuración de la encimera Durian® a medida, son necesarias las cotas, grosor y la ubicación del lavabo y de la grifería. En caso de no indicarse se suministrará por defecto.

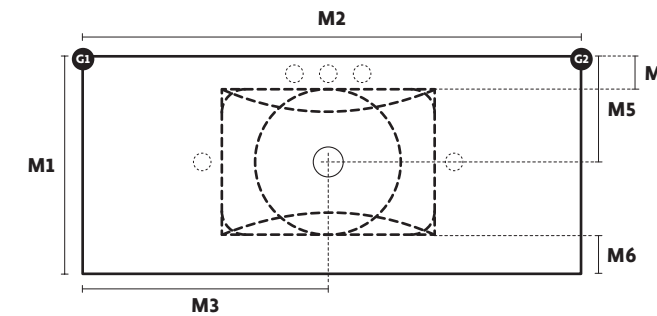

IMPRESINDIBLES	M1	Fondo encimera (vuelos incluidos).
	M2	Largo encimera (vuelos incluidos).
	M3	Distancia de pared a eje válvula (necesario solo para lavabos descentrados).
OPCIONALES	M4	Distancia pared a inicio lavabo (obligatorio cuando la grifería va en pared).
	M5	Ubicación del lavabo en profundidad.
	M6	Distancia del lavabo al borde frontal exterior.
	G1	Ángulo izquierdo distinto a 90°.
	G2	Ángulo derecho distinto a 90°.

ESPEORES DE ENCIMERA

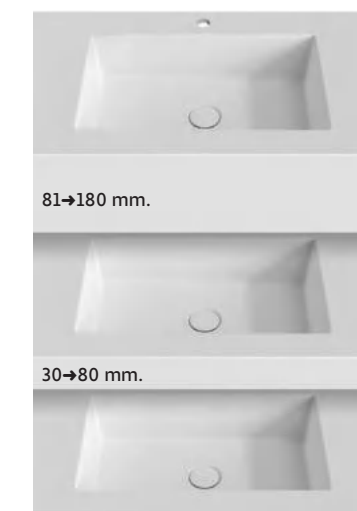

12 mm.

Durian® nos permite personalizar el grosor de la encimera partiendo de la placa base de 12 mm. recreando el perímetro hasta el espesor requerido.

CERTIFICADO DE CALIDAD



Durian® en colaboración con el Instituto Tecnológico de Ámbito Internacional AIDIMME con reconocimiento por el Ministerio de Ciencia e Innovación, ha certificado que nuestros productos cumplen todos los requisitos que garantizan su comercialización con las exigencias técnicas necesarias para su uso.

durian BARI



bari con perímetro

/60 - 90 cm./

Referencia	Ancho hasta	Fondo	Alto	Lavabo 60	Lavabo 90
180 OZO 080 2P0	81	37→53	12	512	-
180 OZO 090 2P0	91	37→53	12	572	-
180 OZO 100 2P0	101	37→53	12	608	668
180 OZO 110 2P0	111	37→53	12	660	721
180 OZO 120 2P0	121	37→53	12	713	774
180 OZO 140 2P0	141	37→53	12	1003	1064
180 OZO 160 2P0	161	37→53	12	1128	1190
180 OZO 180 2P0	181	37→53	12	1297	1358

- Z=6 Lavabo 60 / Z=9 Lavabo 90 / P=1 Lavabo izq. / P=2 Lavabo dch.
- Con grifo trasero fondo mínimo 45 cm. Sin grifo trasero fondo mínimo 37 cm.
- Válvula no incluida.

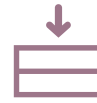

INSTALACIÓN SOBRE MOBILIARIO O ESTRUCTURA METÁLICA

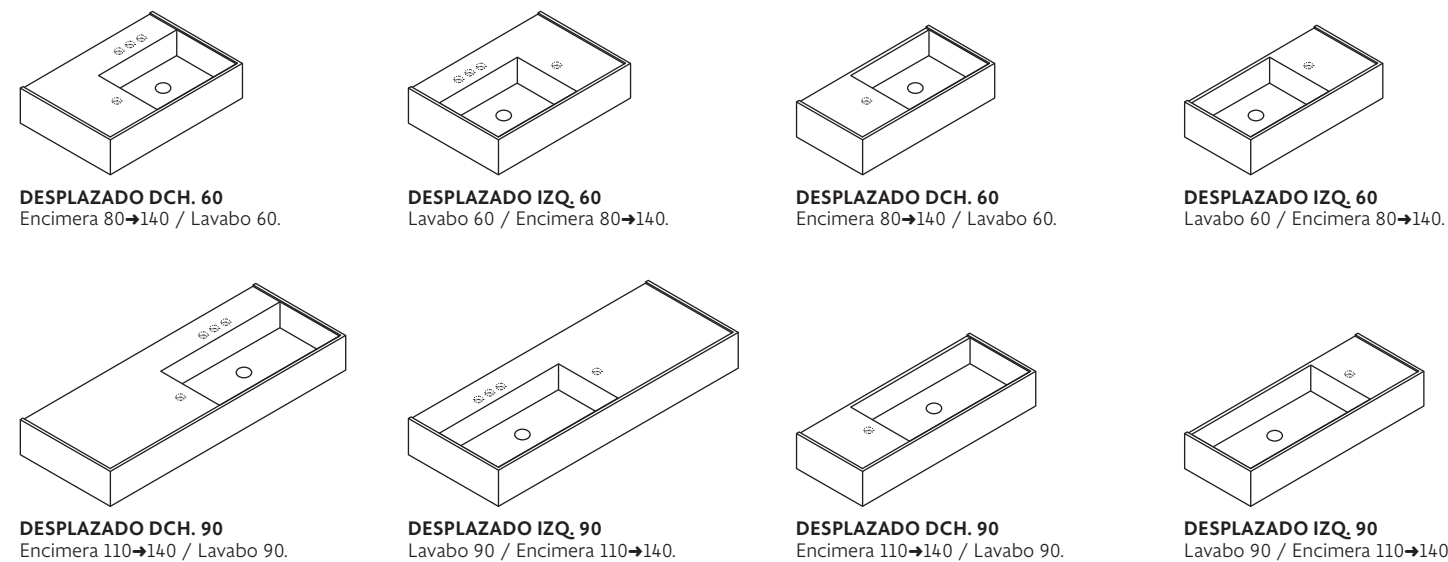
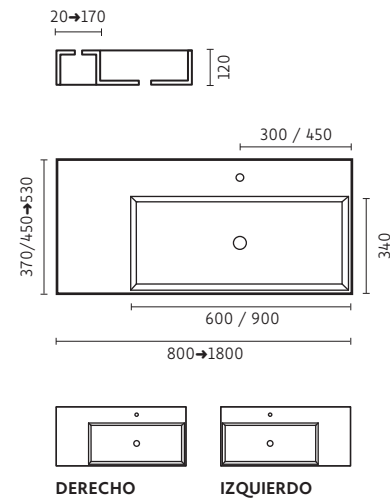

durian BARI



bari sin perímetro

/60 - 90 cm./

Referencia	Ancho hasta	Fondo	Alto	Lavabo 60	Lavabo 90
180 OZO 080 1P0	81	37→53	12	503	-
180 OZO 090 1P0	91	37→53	12	561	-
180 OZO 100 1P0	101	37→53	12	596	658
180 OZO 110 1P0	111	37→53	12	647	709
180 OZO 120 1P0	121	37→53	12	700	760
180 OZO 140 1P0	141	37→53	12	983	1045
180 OZO 160 1P0	161	37→53	12	1107	1169
180 OZO 180 1P0	181	37→53	12	1274	1336

- Z=6 Lavabo 60 / Z=9 Lavabo 90 / P=1 Lavabo izq. / P=2 Lavabo dch.
- Con grifo trasero fondo mínimo 45 cm. Sin grifo trasero fondo mínimo 37 cm.
- Válvula no incluida.



INSTALACIÓN SOBRE MOBILIARIO O ESTRUCTURA METÁLICA

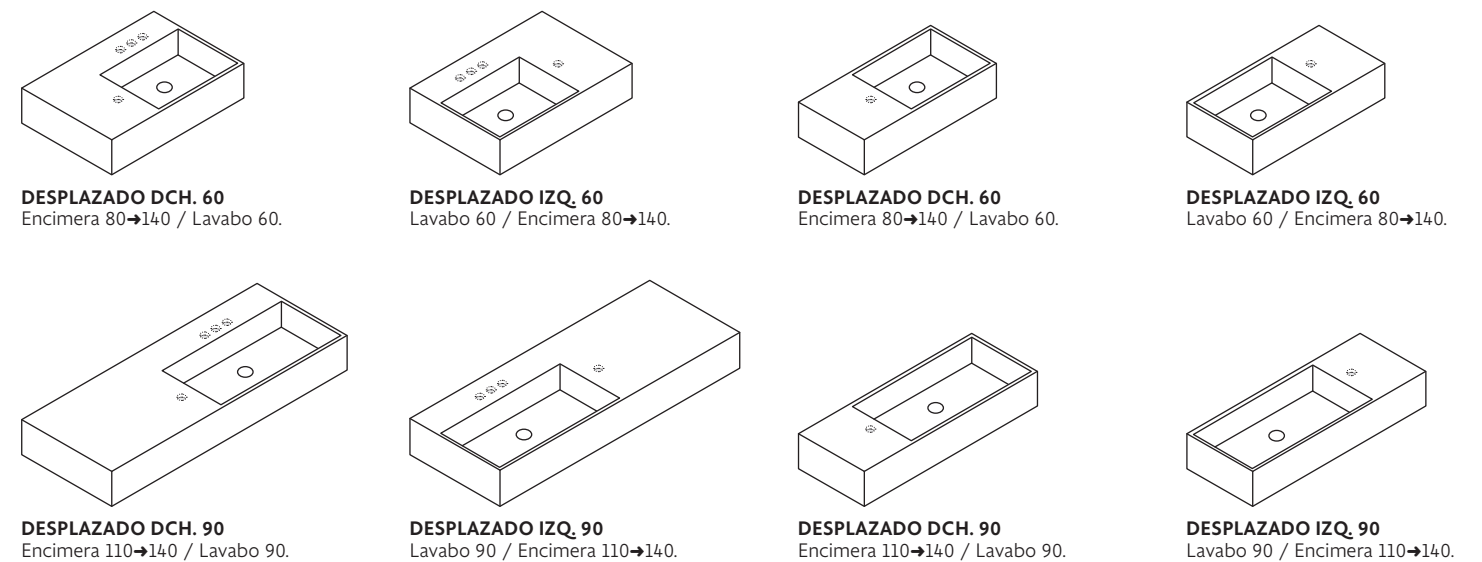
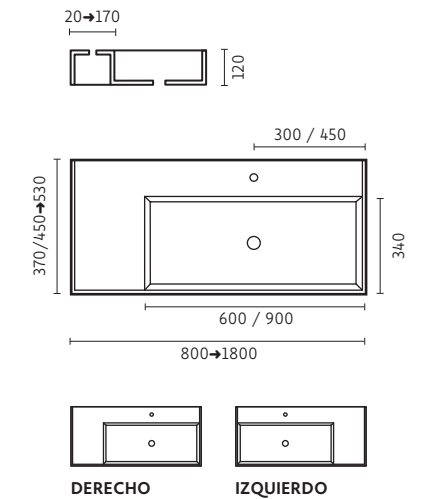

durian NANTES



nantes

/45 cm./

STOCK

Referencia	Medida	Durian	Laca Select Mate	Oro
378 040 XXX 1PZ	45 x 30 x 14h.	421	589	648

• P=1 (IZQUIERDO) P=2 (DERECHO). Indicar mano.
 • Z=0 (DURIAN) Z=2 (LACADO) Z=3 (METALIZADO)

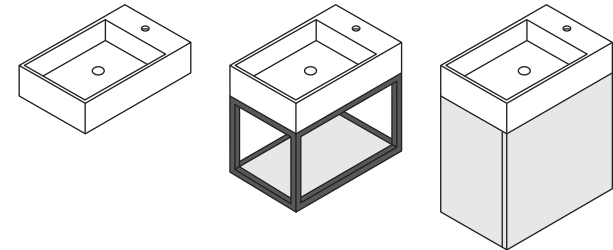
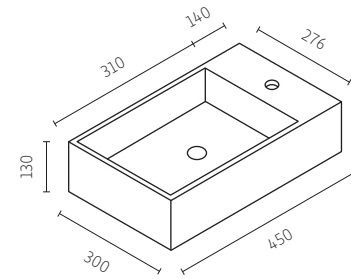

Instalación sobre mobiliario, estructura metálica o suspendido a pared.

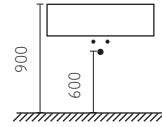

durian PICCOLO



piccolo

/36 cm./

STOCK

Referencia	Medida	Durian	Laca Select Mate	Oro
378 030 XXX 1PZ	36 x 20 x 11h.	280	392	431

• P=1 (IZQUIERDO) P=2 (DERECHO). Indicar mano.
 • Z=0 (DURIAN) Z=2 (LACADO) Z=3 (METALIZADO)

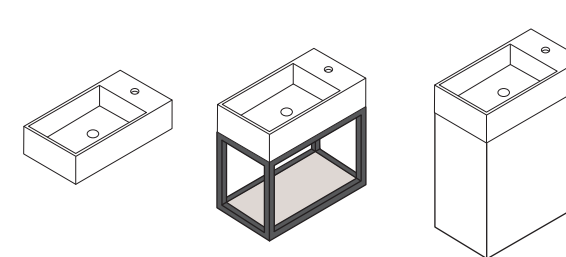
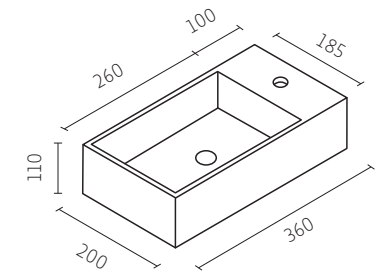

Instalación sobre mobiliario, estructura metálica o suspendido a pared.

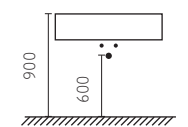



durian®

ENCIMERAS Y LAVABOS

durian® TARIFA ENCIMERAS

sin lavabo

GROSOR 1,2
Encimera para lavabo sobre encimera.

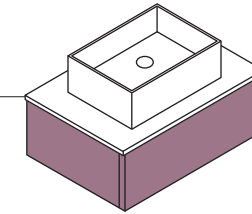

GROSOR 3→8
Encimera para lavabo semi-encastre.

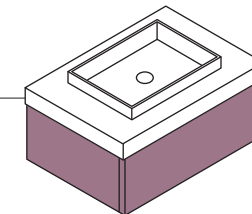

GROSOR 8,1→18
Encimera sin lavabo.

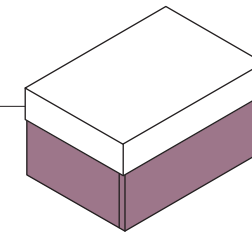

con lavabo

GROSOR 1,2
Encimera para lavabo encastrado.

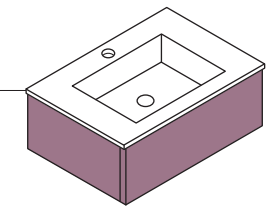

GROSOR 3→8
Encimera para lavabo encastrado.

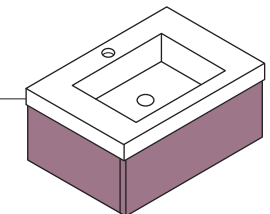

GROSOR 8,1→18
Encimera para lavabo encastrado.

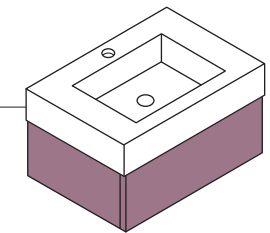

Referencia	Ancho hasta	Grosor 1,2	Grosor 3→8	Grosor 8,1→18
501 000 041 Y00	41	150	182	199
501 000 051 Y00	51	164	199	219
501 000 061 Y00	61	181	222	245
501 000 071 Y00	71	196	238	262
501 000 081 Y00	81	212	251	275
501 000 091 Y00	91	230	288	318
501 000 101 Y00	101	248	293	323
501 000 111 Y00	111	265	314	344
501 000 121 Y00	121	286	338	370
501 000 131 Y00	131	303	369	406
501 000 141 Y00	141	322	399	439
501 000 151 Y00	151	344	418	461
501 000 161 Y00	161	363	436	479
501 000 171 Y00	171	384	454	498
501 000 181 Y00	181	433	507	559
501 000 191 Y00	191	456	530	582
501 000 201 Y00	201	478	548	605
501 000 211 Y00	211	500	582	639
501 000 221 Y00	221	520	607	667

Referencia	Ancho hasta	Grosor 1,2	Grosor 3→8	Grosor 8,1→18
SSS MMM 061 YP0	61	308	380	418
SSS MMM 071 YP0	71	348	422	467
SSS MMM 081 YP0	81	380	448	492
SSS MMM 091 YP0	91	401	499	549
SSS MMM 101 YP0	101	449	532	584
SSS MMM 111 YP0	111	489	577	636
SSS MMM 121 YP0	121	531	625	687
SSS MMM 131 YP0	131	618	752	826
SSS MMM 141 YP0	141	708	878	965
SSS MMM 151 YP0	151	765	933	1025
SSS MMM 161 YP0	161	823	987	1086
SSS MMM 171 YP0	171	896	1061	1169
SSS MMM 181 YP0	181	968	1136	1249
SSS MMM 191 YP0	191	1029	1193	1312
SSS MMM 201 YP0	201	1088	1250	1375
SSS MMM 211 YP0	211	1231	1425	1568
SSS MMM 221 YP0	221	1423	1659	1817

- Y=0 Grosor 1,2 cm. / Y=1 Grosor 3→8 cm. / Y=2 Grosor 8,1→18 cm.
- El precio incluye el orificio de desagüe y de grifería para lavabos Durian®.
- Para lavabos de otros fabricantes +90€/calado.
- Medidas de 221 -230 cm, requieren de embalaje especial de madera (120€/netos). Medidas superiores a 231 cm, consultar precio y viabilidad.

- SSS=Referencia lavabo.
- MMM=Medida lavabo.
- Y=0 Grosor 1,2 cm. / Y=1 Grosor 3→8 cm. / Y=2 Grosor 8,1→18 cm.
- P=0 Lavabo centrado. / P=1 Lavabo desplazado.
- Válvula y soportes no incluidos.
- Medidas de 221 -230 cm, requieren de embalaje especial de madera (120€/netos). Medidas superiores a 231 cm, consultar precio y viabilidad.



durian ENCIMERAS

FONDO ≥48 cm. CON GRIFO TRASERO

pisa flat con tapa

/50 - 59 - 100 cm./



- Para encimera 1,2 cm. altura mínima de cajón 26 cm.
- Fondo mínimo mobiliario 48 cm. (uñero recto 49 cm.).
- Incremento de lavabo cm 100 +110€.
- Compatible con válvula clicker opcional.
- Incremento de tapa +110€.

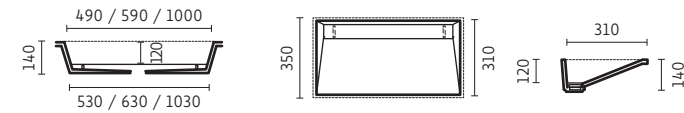

ferrara con tapa

/50 - 59 cm./



- Para encimera 1,2 cm. altura mínima de cajón 24 cm.
- Fondo mínimo mobiliario 48 cm.
- Incremento de tapa +110€.
- Por omisión, tapa perimetral izq. y grifería a 17 cm. del inicio del lavabo.

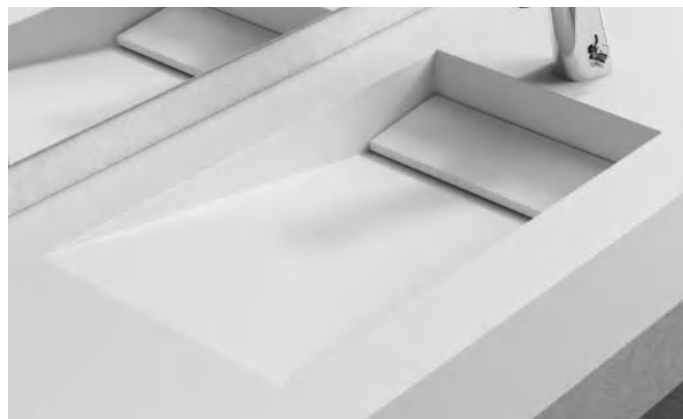
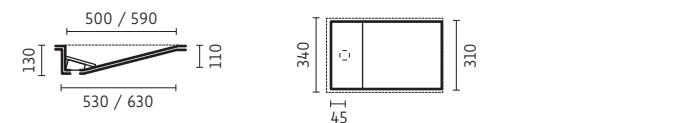

ferrara sin tapa

/50 - 59 cm./



- Para encimera 1,2 cm. altura mínima de cajón 24 cm.
- Fondo mínimo mobiliario 48 cm.

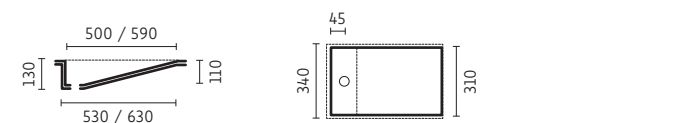

sicilia

/44 - 50 - 60 cm./



- Para encimera 1,2 cm. altura mínima de cajón 25 cm.
- Fondo mínimo mobiliario 48 cm. (uñero recto 49 cm.).
- Incrementos de medida en 60 cm. +60€.

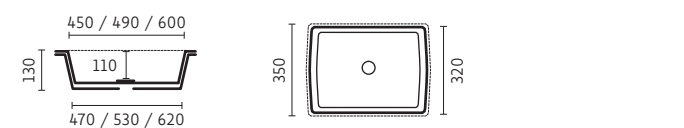

milano con tapa

/59 cm./



- Para encimera 1,2 cm. altura mínima de cajón 28 cm.
- Fondo mínimo mobiliario 48 cm. (uñero recto 49 cm.).
- Incremento de tapa +80€.
- Desagüe atrasado



milano sin tapa

/59 cm./



- Para encimera 1,2 cm. altura mínima de cajón 28 cm.
- Fondo mínimo mobiliario 48 cm. (uñero recto 49 cm.).
- Desagüe atrasado



bologna

/50 cm./



- Para encimera 1,2 cm. altura mínima de cajón 24 cm.
- Fondo mínimo mobiliario 48 cm.

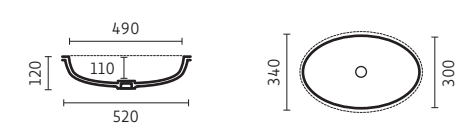

new napoli

/Ø32 cm./



- Para encimera 1,2 cm. altura mínima de cajón 24 cm.
- Fondo mínimo mobiliario 48 cm. (uñero recto 49 cm.).

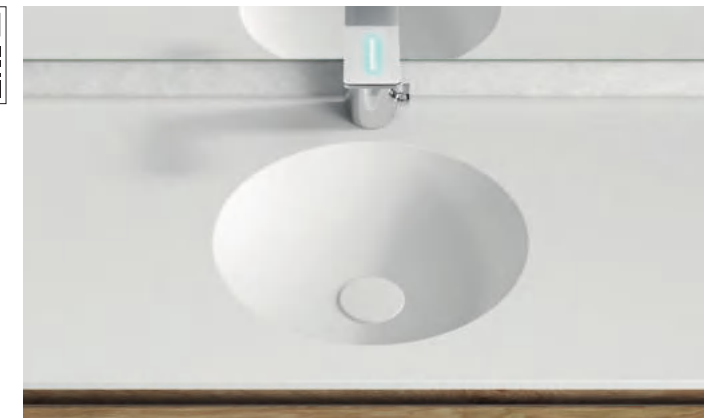

durian ENCIMERAS

FONDO ≥46 cm. CON GRIFO TRASERO

elba

/40 - 50 - 60 - 110 cm./



- Para encimera 1,2 cm. altura mínima de cajón 24 cm.
- Fondo mínimo mobiliario 46 cm.
- Incrementos de medida en 60 cm. +60€ y 110 cm. +110€.

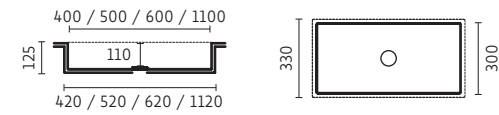

elba slim

/50 cm./



- Para encimera 1,2 cm. altura mínima de cajón 24 cm.
- Fondo mínimo mobiliario 46 cm.



florence

/40 - 50 cm./



- Para encimera 1,2 cm. altura mínima de cajón 24 cm.
- Fondo mínimo mobiliario 46 cm. (uñero recto 47 cm.).

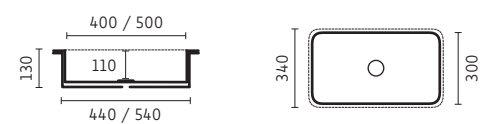

florence L /60 - 80 cm./

- Para encimera 1,2 cm. altura mínima de cajón 28 cm.
- Fondo mínimo mobiliario 46 cm. (uñero recto 47 cm.).
- Incrementos de medida en 60 cm. +60€ y 80 cm. +80€.

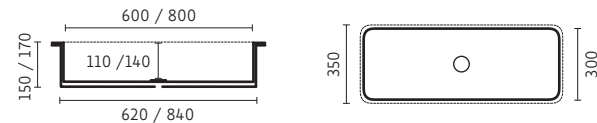

florence XL

/100 cm./



- Para encimera 1,2 cm. altura mínima de cajón 28 cm.
- Fondo mínimo mobiliario 46 cm. (uñero recto 47 cm.).
- Incremento de medida +110€.
- Opción 2º orificio grifería +33€.

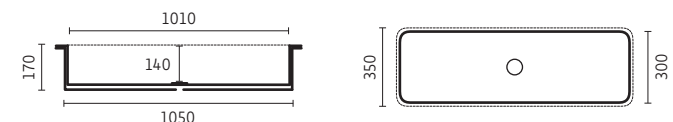

FONDO ≥46 cm. CON GRIFO TRASERO

asis

/46 cm./



- Para encimera 1,2 cm. altura mínima de cajón 24 cm.
- Fondo mínimo mobiliario 46 cm.
- Desagüe atrasado

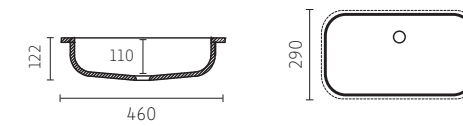

new siena

/45 cm./



- Para encimera 1,2 cm. altura mínima de cajón 24 cm.
- Fondo mínimo mobiliario 46 cm.

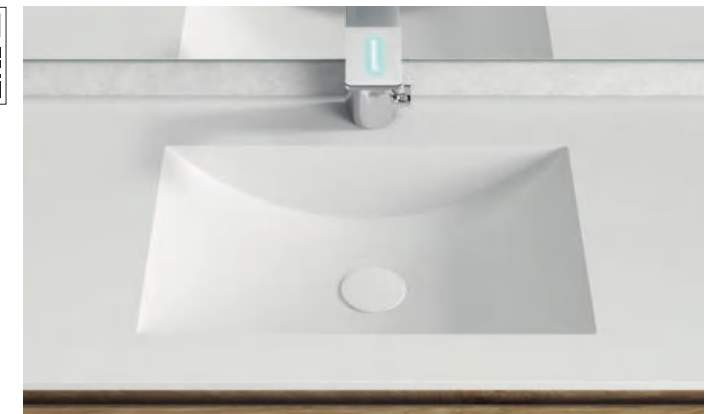

new capri

/50 cm./



- Para encimera 1,2 cm. altura mínima de cajón 24 cm.
- Fondo mínimo mobiliario 46 cm.
- Desagüe atrasado

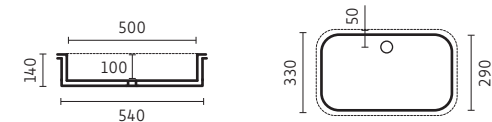

venecia

/59 cm./



- Para encimera 1,2 cm. altura mínima de cajón 24 cm.
- Fondo mínimo mobiliario 46 cm. (uñero recto 47 cm.).
- Solo válido para mueble bajo lavabo con anchura mínima de 75 cm.



durian ENCIMERAS

FONDO ≥40 cm. CON GRIFO TRASERO

siena mini

/48 cm./



- Para encimera 1,2 cm. altura mínima de cajón 24 cm.
- Fondo mínimo mobiliario 40 cm.



turin

/33 cm./



- Para encimera 1,2 cm. altura mínima de cajón 24 cm.
- Fondo mínimo mobiliario 40 cm. (uñero recto 41 cm.).



elba mini

/40 cm./



- Para encimera 1,2 cm. altura mínima de cajón 26 cm.
- Fondo mínimo mobiliario 40 cm. (uñero recto 41 cm.).



florence mini

/40 cm./



- Para encimera 1,2 cm. altura mínima de cajón 26 cm.
- Fondo mínimo mobiliario 40 cm.



durian CORTES EN ENCIMERAS



rectos

Referencia	Corte	PVP
901 100 000 007	L	75
901 100 000 002	U	75
901 100 000 003	diagonal	75

- Cortes válidos para encimeras de 1,2 cm. de grueso.
- Indicar cotas de corte.



curvo oval

Referencia	PVP
901 100 000 005	110

- Cortes válidos para encimeras de 1,2 cm. de grueso.
- Indicar cotas de corte y confirmar viabilidad.



esquina redonda

Referencia	PVP
901 100 000 004	45

- Cortes válidos para encimeras de 1,2 cm. de grueso.
- Indicar radio.



corte personalizado

Referencia	PVP
901 100 000 008	175

- Cortes válidos para encimeras de 1,2 cm. de grueso.
- Confirmar viabilidad. Necesario aportar plantilla o dibujo DXF.





durian CONTOUR LINE

contour line zona húmeda

Referencia	Medida	PVP
901 100 000 042	hasta 100	150

- Marco de 1 cm. de ancho.
- Mínimo facturable 1 metro. Precio por metro lineal.

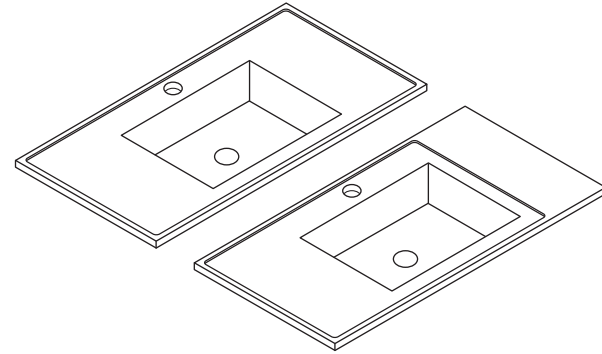

contour line jabonera

Referencia	Medida	PVP
901 100 000 040	8 x 10	75

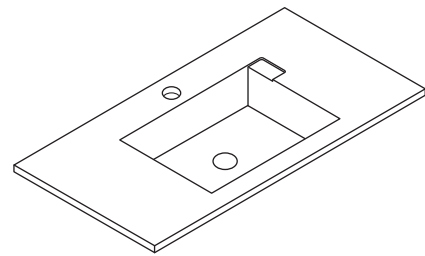

contour line amenities

Referencia	Medida	PVP
901 100 000 041	hasta 20 x 40	95

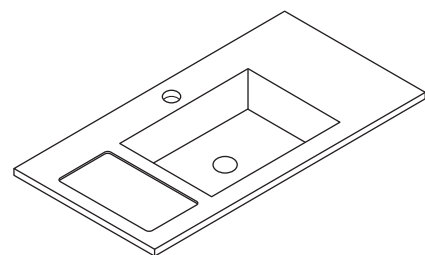

durian MECANIZADOS

slim line 6 mm.

Referencia	Fresado	Ancho hasta 120	Ancho 121+220
901 100 000 081	frontal	95	145
901 100 000 082	izquierdo	50	-
901 100 000 083	derecho	50	-

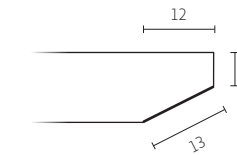

mecanizado tapete para sobre encimera

Referencia	Mecanizado	PVP
901 100 000 056	ROMA	95
901 100 000 057	NEW POMPEI	145

- Grosor 1,2 cm. Fondo mínimo 50 cm.

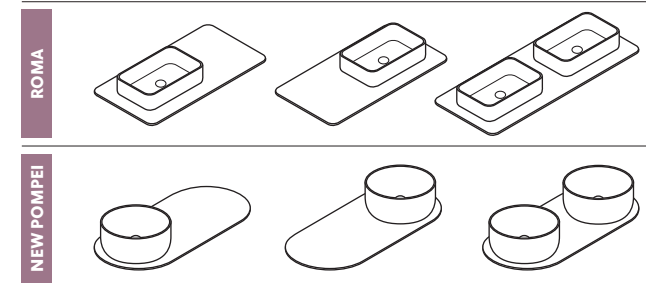

mecanizado tapete para encimera

Referencia	Mecanizado	PVP
901 100 000 058	radio 20	145

- Grosor 1,2 cm. Fondo mínimo 50 cm.

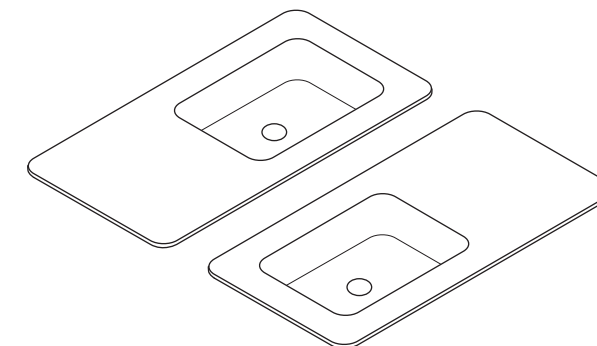



durian TOALLEROS

mecanizado toallero superior

Referencia	Medida	Ancho 30→50
901 100 000 035	Izquierdo	98/und.
901 100 000 037	Derecho	98/und.

- Vuelo mínimo 8 cm. (2+4+2).
- Para calcular su precio, añadir 10 cm. a la anchura de la encimera + mecanizado toallero.

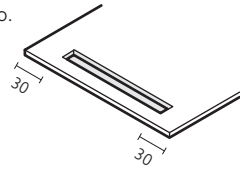

mecanizado toallero frontal/lateral

Referencia	Medida	PVP
901 100 000 031	0→30 cm.	76/und.
901 100 000 031	30,1→50 cm.	86/und.
901 100 000 031	50,1→70 cm.	98/und.

- Indicar posición.
- Centrado en altura.
- Altura mínima faldón 8 cm.

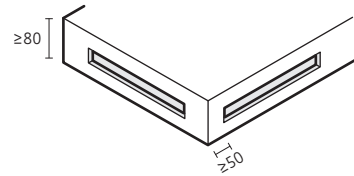

mecanizado toallero estructura

Referencia	Medida	PVP
901 100 000 029	0→30 cm.	76/und.
901 100 000 029	30,1→50 cm.	86/und.
901 100 000 029	50,1→80 cm.	98/und.

- Indicar posición.
- Altura mínima faldón 8 cm.

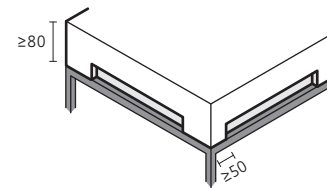

mecanizado + toallero verso

Referencia	Medida	PVP
901 100 000 096	38,5 x 5 x 3,5h	85

- Se suministra suelto, indicar posición.

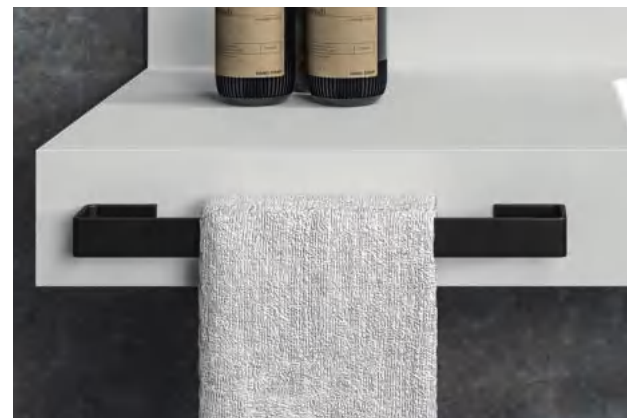
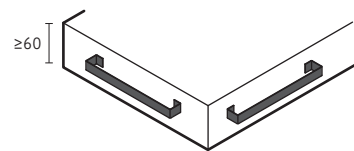

durian COMPLEMENTOS

rebosadero + tubo

Referencia	PVP
901 100 000 014	90

- No válido para: Venezia, New Napoles y Bologna.
- Solo opción centrado.
- Necesario según Código Técnico de Edificación (CTE).

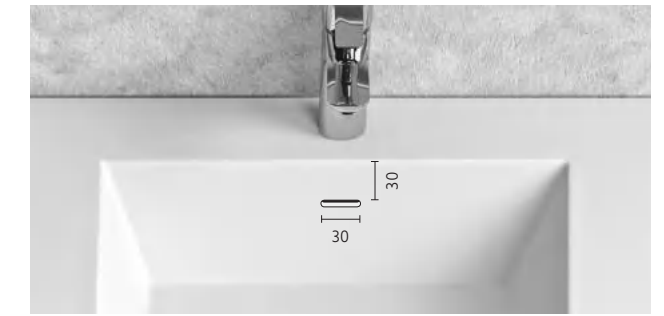
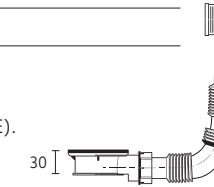

copete recto sin unión

Referencia	Medida	PVP
503 XXX YYY 110	6 cm.	70/m.
503 XXX YYY 110	7→15 cm.	90/m.
503 XXX YYY 110	16→35 cm.	160/m.

- Mínimo facturable 1 metro. Copete suelto sin encimera +35€.
- Orificio grifo Ø<5 cm +33€/und, Ø>5 cm. +98€/und.



copete media caña

Referencia	Medida	PVP
503 XXX YYY 120	6 cm.	165/m.
503 XXX YYY 120	7→15 cm.	195/m.
503 XXX YYY 120	16→35 cm.	230/m.

- Mínimo facturable 1 metro
- Orificio grifo Ø<5 cm +33€/und, Ø>5 cm. +98€/und.



lavabo extra

PVP
150/und.

- Ubicación personalizable.



fondo XL

Medida	PVP
53→65 cm.	+20%





durian[®] ON CONCEPT

durian[®] TODI

todi sobre encimera

/Ø40 cm./

✓
STOCK

Referencia	Medida	Durian [®]	Laca Select Mate	Oro
178	Ø40 x 14h.	395	553	608

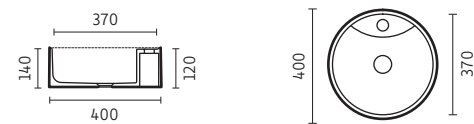

durian[®] FORLI

forli sobre encimera

/40 cm./

✓
STOCK

Referencia	Medida	Durian [®]	Laca Select Mate	Oro
183	40 x 40 x 14h	396	554	609



durian[®] RHO

rho sobre encimera

/Ø40 cm./

✓
STOCK

Referencia	Medida	Durian [®]	Laca Select Mate	Oro
181	Ø40 x 14h	391	547	602



durian[®] SONA

sona sobre encimera

/41 cm./

✓
STOCK

Referencia	Medida	Durian [®]	Laca Select Mate	Oro
184	41 x 34 x 15h	391	547	602

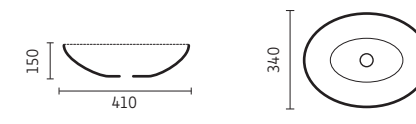

durian ROMA

roma sobre encimera

/43 - 53 - 63 - 83 - 103 cm./

✓
STOCK

Ref.	Medida	Durian*	Laca Select Mate	Oro
146	43 x 33 x 13h.	385	575	632
	53 x 33 x 13h.	416	601	661
	63 x 33 x 15h.	442	643	707
	83 x 33 x 15h.	514	722	794
	103 x 33 x 15h.	598	804	884

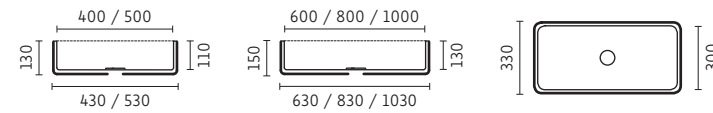

roma semi encastrado

/43 - 53 cm./

✓
STOCK

Ref.	Medida	Durian*	Laca Select Mate	Oro
176	43 x 33 x 13h.	385	575	632
	53 x 33 x 13h.	416	601	661

* Rebaje perimetral de encastre 0,5 cm.

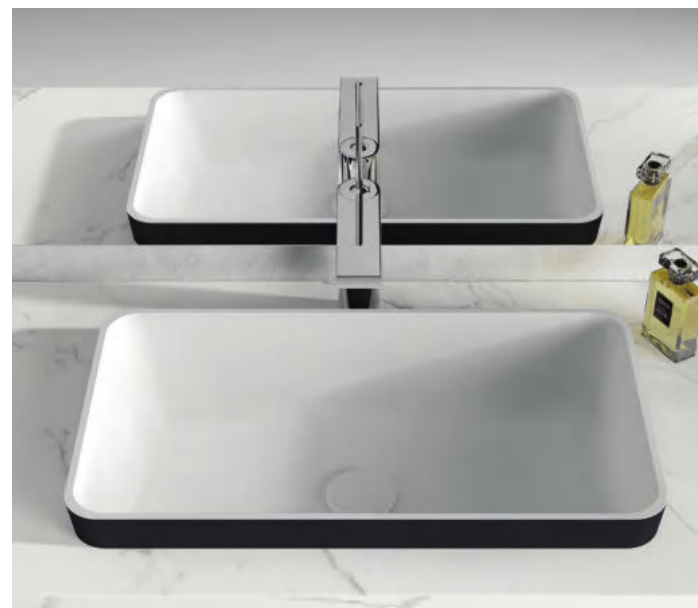

durian GENOVA

genova sobre encimera

/54 cm./

✓
STOCK

Ref.	Medida	Durian*	Laca Select Mate	Oro
145	54,5 x 33 x 15,5h.	426	650	715

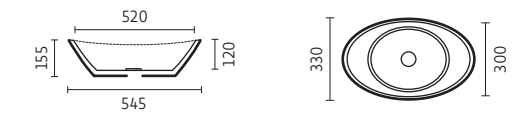

genova semi encastrado

/54 cm./

✓
STOCK

Ref.	Medida	Durian*	Laca Select Mate	Oro
175	54,5 x 33 x 15,5h.	426	650	715

* Rebaje perimetral de encastre 0,5 cm.

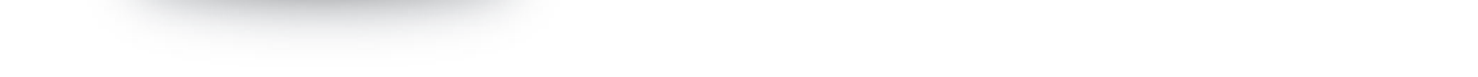
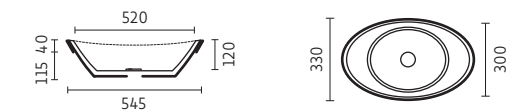

durian VERONA

verona sobre encimera

/63 cm./

✓
STOCK

Ref.	Medida	Durian*	Laca Select Mate	Oro
144	63 x 35 x 15,5h.	455	624	687



verona semi encastrado

/63 cm./

✓
STOCK

Ref.	Medida	Durian*	Laca Select Mate	Oro
174	63 x 35 x 15,5h.	455	624	687

• Rebaje perimetral de encastre 0,5 cm.



durian NEW POMPEI

new pompeii sobre encimera

/Ø40 cm./

✓
STOCK

Ref.	Medida	Durian*	Laca Select Mate	Oro
170	Ø40 x 13,5h	430	625	688



new pompeii semi encastrado

/Ø40 cm./

✓
STOCK

Ref.	Medida	Durian*	Laca Select Mate	Oro
172	Ø40 x 13,5h	430	625	688

• Rebaje perimetral de encastre 0,5 cm.



durian[®] NEW TRENTO

new trento sobre encimera

/37 cm./

STOCK

Ref.	Medida	Durian [®]	Laca Select Mate	Oro
171	37 x 37 x 12h.	402	595	654



new trento semi encastrado

/37 cm./

STOCK

Ref.	Medida	Durian [®]	Laca Select Mate	Oro
173	37 x 37 x 12h.	402	595	654

• Rebaje perimetral de encastre 0,5 cm.

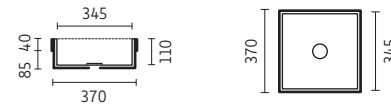

new trento altura XL

/37 cm./

STOCK

Ref.	Medida	Durian [®]	Laca Select Mate	Oro
371	37 x 37 x 40h.	634	888	977

PERSONALIZADO

Ref.	Medida	Durian [®]
371	37 x 37 x 20→40h.	695

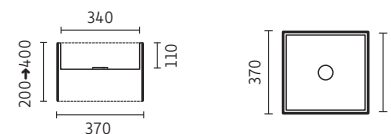

durian[®] PALERMO

palermo sobre encimera

/50 cm./

STOCK

Ref.	Medida	Durian [®]	Laca Select Mate	Oro
177	37 x 37 x 12h.	441	638	702

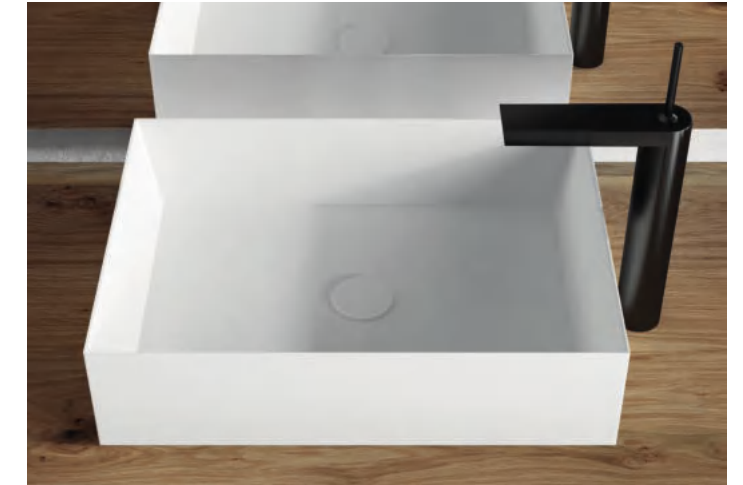

palermo semi encastrado

/50 cm./

STOCK

Ref.	Medida	Durian [®]	Laca Select Mate	Oro
182	50 x 37 x 12h.	441	638	702

• Rebaje perimetral de encastre 0,5 cm.

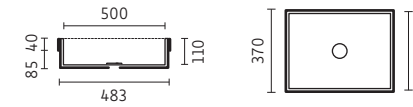

palermo altura XL

/50 cm./

STOCK

Ref.	Medida	Durian [®]	Laca Select Mate	Oro
377	52 x 37 x 40h.	697	976	1074

PERSONALIZADO

Ref.	Medida	Durian [®]
377	52 x 37 x 20→40h.	765

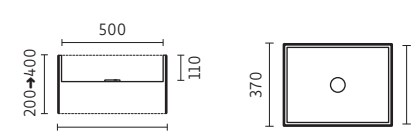

CERAMIC EXCLUSIVE



GRAN DUREZA



GRAN CALIDAD



GROSOR EXTRAFINO

CERAMIC



PINTADO A MANO



ACABADO MATE

exclusive calacatta

/Ø40 cm./

Referencia	Medida	PVP
V180NC	Ø40 x 14h.	890

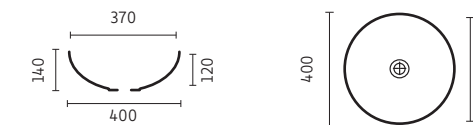

PINTADO A MANO



ACABADO MATE

exclusive marquina

/Ø40 cm./

Referencia	Medida	PVP
V180NM	Ø40 x 14h.	890

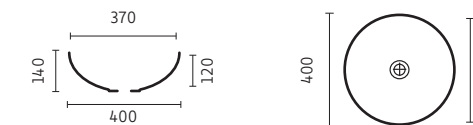

BLANCO BRILLO

exclusive blanco

/Ø40 cm./

Referencia	Medida	PVP
V180NB	Ø40 x 14h.	195

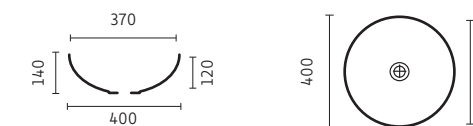



RESISTENCIA RALLADO



GRAN CALIDAD



RESISTENCIA QUÍMICA



OPCIÓN COLOR



GRAN CALIDAD



GROSOR EXTRAFINO

esencial

/42 cm./



BLANCO BRILLO

Referencia	Color	Medida	PVP
V1001N040	Blanco	42 x 42 x 16h.	175

• Esmaltado 3 caras.

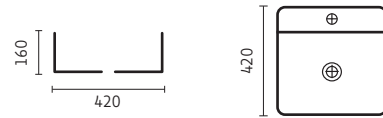

new stadium extrafino

/46 cm./



BLANCO BRILLO



NEGRO MATE

Referencia	Color	Medida	PVP
V130NB	Blanco brillo	46 x 32,5 x 13sh.	160
V130NN	Negro mate	46 x 32,5 x 13sh.	255

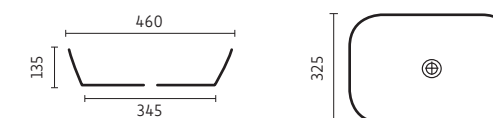

bowl extrafino

/Ø35 cm./



BLANCO BRILLO



GROSOR EXTRAFINO

Referencia	Color	Medida	PVP
V1501N035	Blanco	Ø35 x 11h.	175



circle extrafino

/Ø36 cm./



BLANCO BRILLO



NEGRO MATE

Referencia	Color	Medida	PVP
V140NB	Blanco brillo	Ø36 x 11h.	195
V140NN	Negro mate	Ø36 x 11h.	285



oval light

/41 cm./



BLANCO BRILLO

Referencia	Color	Medida	PVP
V1201N041	Blanco	41 x 34 x 15h.	175

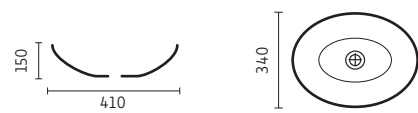

new square extrafino

/37 cm./



BLANCO BRILLO



NEGRO MATE

Referencia	Color	Medida	PVP
V160NB	Blanco brillo	37 x 37 x 11h.	215
V160NN	Negro mate	37 x 37 x 11h.	345



CERAMIC RIVER



river 46 centrado

Referencia	M2	M1	M3	M9	M11	H	V	PVP
RV010NN061	61	46	cent.	43	27	12	17	155
RV010NN071	71	46	cent.	52	27	12	17	170
RV010NN081	81	46	cent.	52	27	12	17	190
RV010NN091	91	46	cent.	52	27	12	17	215
RV010NN101	101	46	cent.	52	27	12	17	230
RV010NN121	121	46	cent.	62	27	12	17	345

• Para Uñero recto y Gola en P2.

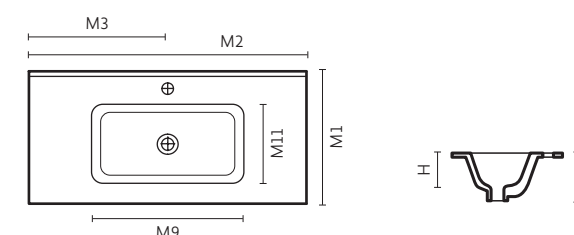

river 46 descentrado dch./izq.

Referencia	Lavab.	M2	M1	M3	M9	M11	H	V	PVP
RV020NN091	izq.	91	46	30,5	44	26	12	17	265
RV020NN101	izq.	101	46	36	52	26	12	17	285
RV050NN091	dch.	91	46	30,5	44	26	12	17	265
RV050NN101	dch.	101	46	36	52	26	12	17	285

• Para Uñero recto y Gola en P2.

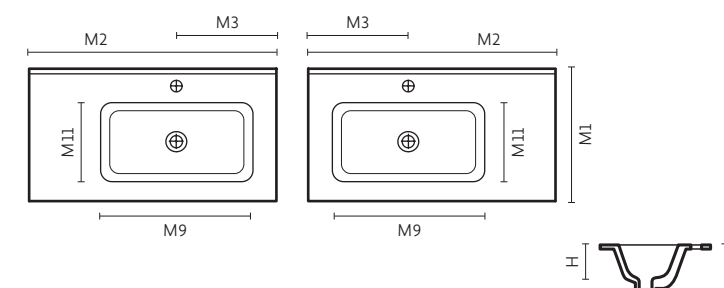

IZQUIERDO

river 40 centrado fondo reducido

Referencia	M2	M1	M3	M9	M11	H	V	PVP
RV030NN061	61	40	cent.	43	22	12	17	180
RV030NN071	71	40	cent.	43	22	12	17	190
RV030NN081	81	40	cent.	43	22	12	17	195

• Para Uñero recto y Gola en P2.

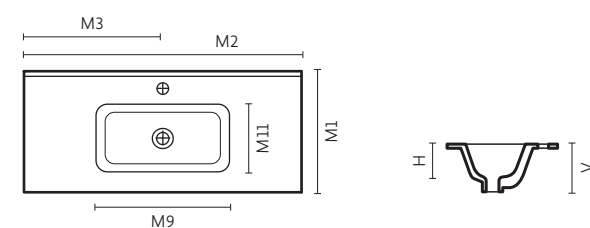

river 46 doble lavabo

Referencia	M2	M1	M3	M9	M11	H	V	PVP
RV040NN121	121	46	30,5	41	27	12	17	375
RV040NN141	141	46	35,5	50	27	12	17	665

• Para Uñero recto y Gola en P2.

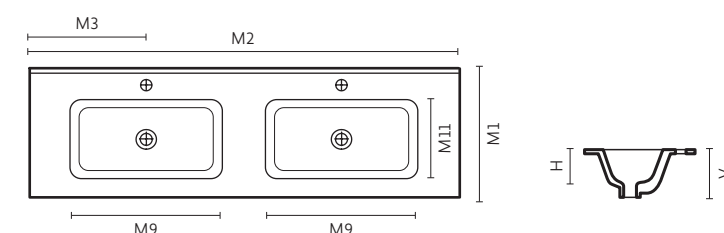

CERAMIC CUADRO



cuadro 46 centrado



Referencia	M2	M1	M3	M9	H	V	PVP
V0101N061	61	46	cent.	43	13	17	135
V0101N071	71	46	cent.	45	13	17	155
V0101N081	81	46	cent.	45	13	17	165
V0101N091	91	46	cent.	46	13	17	195
V0101N101	101	46	cent.	49	13	17	220
V0101N121	121	46	cent.	51	13	17	310

• Para Uñero recto y Gola en P2.

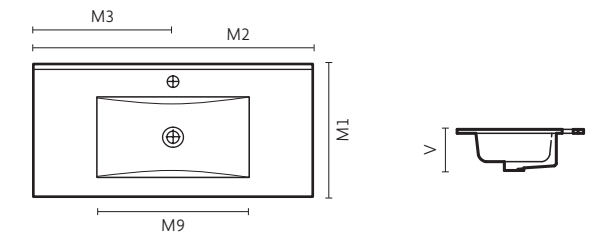

cuadro 46 descentrado dch./izq.

Referencia	Lavabo	M2	M1	M3	M9	H	V	PVP
V0311N091	izq.	91	46	34,5	48	13	17	260
V0311N101	izq.	101	46	36,5	51	13	17	320
V0311N121	izq.	121	46	40	51	13	17	390
V0321N091	dch.	91	46	34,5	48	13	17	260
V0321N101	dch.	101	46	36,5	51	13	17	320
V0321N121	dch.	121	46	40	51	13	17	390

• Para Uñero recto y Gola en P2.

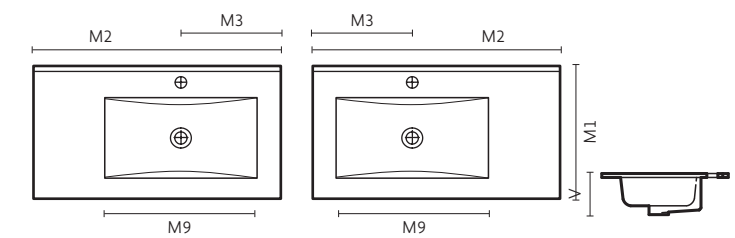

IZQUIERDO

cuadro mini 36 centrado fondo reducido

Referencia	M2	M1	M3	M9	H	V	PVP
V0401N061	61	36,5	cent.	44	9,5	14	135
V0401N071	71	36,5	cent.	44	9,5	14	185
V0401N081	81	36,5	cent.	44	9,5	14	190

• Siempre en P2.

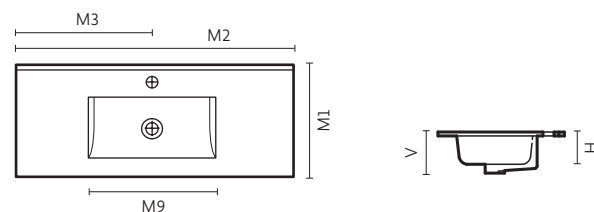

cuadro 46 doble lavabo

Referencia	M2	M1	M3	M9	H	V	PVP
V0102N121	121	46	30,5	41	12	17	395

• Para Uñero recto y Gola en P2.

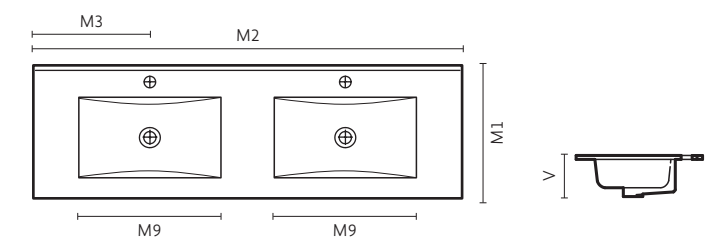

2023

ACABADOS **KYRYA**

FANTASÍA

ARLUX

FENIX

MADERA

LACA SELECT MATE

LACA RAL

Los acabados pueden presentar alguna variación con respecto a la veta y color original del material.

FANTASÍA

ESPACIOS QUE ACOMPAÑAN TU VIDA

La entrada de ensueño a tu espacio KYRYA®.

forest

Tableros laminados que recrean la madera con mucha delicadeza, desde el toque nórdico y minimalista, hasta los robles más elegantes y cosmopolita, la mejor opción para quienes desean generar un ambiente de ilusión y fantasía en su baño.

colors

Tableros laminados llenos de color y fantasía, elegidos para crear una consonancia cromática perfecta sin importar como los combines, explora tu creatividad y dale color a tu vida.

forest

FANTASÍA

Tableros laminados que recrean la madera con mucha delicadeza, desde el toque nórdico y minimalista, hasta los robles más elegantes y cosmopolita, la mejor opción para quienes desean generar un ambiente de ilusión y fantasía en su baño.



FAMA01
ROBLE BLANCO



FAMA13
NORDIC

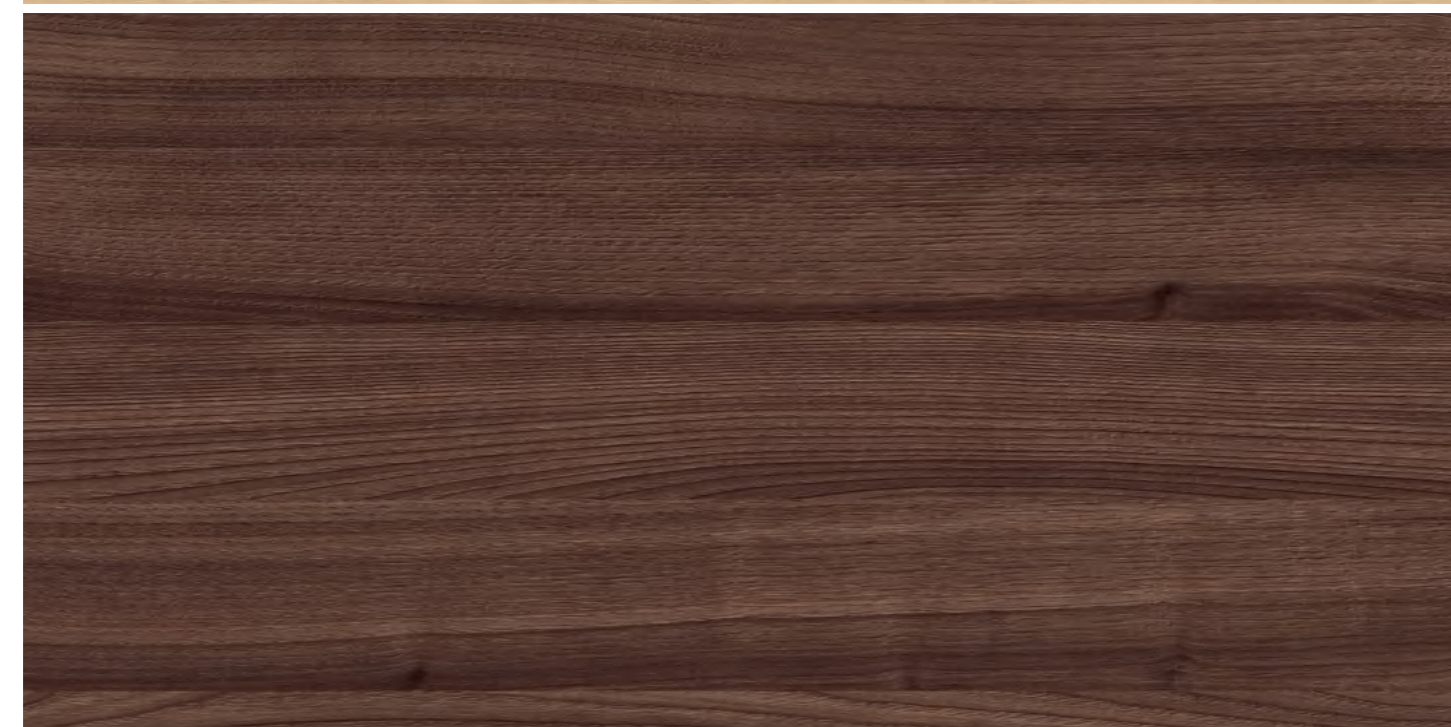

FAMA15
AUSTIN



Más información e instrucciones de montaje.

www.kyrya.es



FAMA03
ROBLE PUCCINI



FAMA11
OLMO WINTER



FAMA12
ROBLE ANDES



FAMA05
ROBLE AZABACHE



colors

FANTASÍA MATE

Tableros laminados llenos de color y fantasía, elegidos para crear una consonancia cromática perfecta sin importar como los combines, explora tu creatividad y dale color a tu vida.



FACO01 BLANCO



FACO02 GREY



FACO03 MARENGO



FACO04 BISCUIT

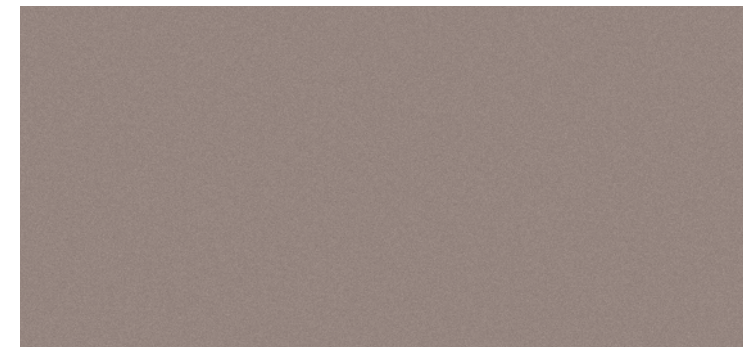

FACO07 NEW TAUPE

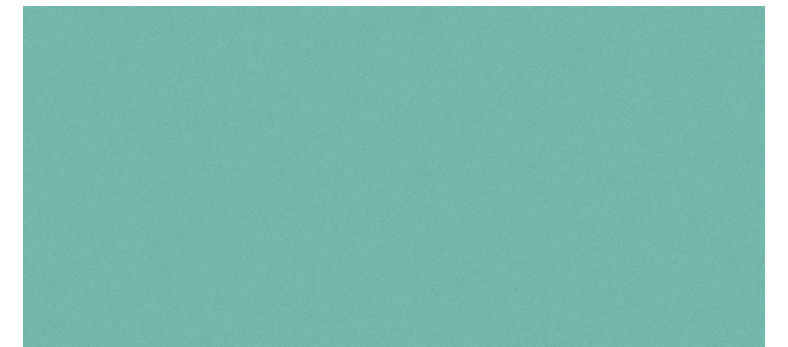

FACO08 CIELO



FACO14 AZUR



FACO13 PRADO



FACO11 MOSTAZA

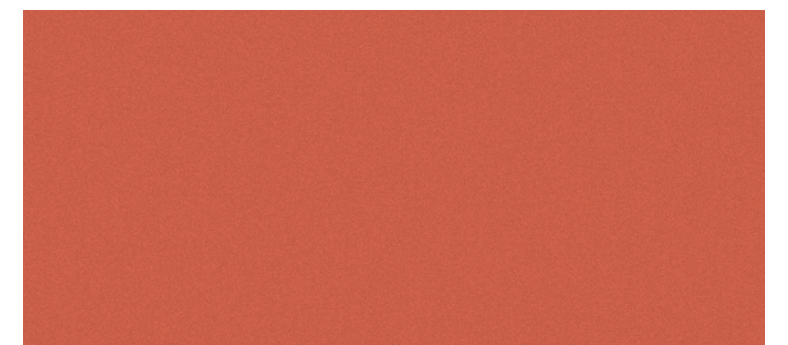

FACO12 ARCILLA

ARLUX

ARTE Y LUJO HECHO MATERIAL

Donde el diseño y la calidad de los materiales se percibe.

gravel

La serie **GRAVEL** de ARLUX nos transportan a los lechos pedregosos de los ríos como inspiración a estos acabados repletos de detalles y texturas. 3 acabados que combinan perfectamente en cualquier baño dando un aspecto natural y elegante. Están realizados con sistemas de alta presión para conseguir una textura y una resistencia al nivel de los estándares de calidad de nuestra gama ARLUX.

touch

La serie **TOUCH** de ARLUX está inspirada en la sinceridad material de elementos industriales para poder dar a los muebles ese aspecto tan ligado a la arquitectura de diseño. Cada acabado tiene un tacto y una textura perfectamente estudiada para conseguir esa sensación de realismo y alta calidad de acabados que desde KYRYA® te ofrecemos en nuestra gama ARLUX.

feel

La serie **FEEL** de ARLUX quiere transportarte a otros lugares, desde una elegante malla de fresno nos acercamos a los matices de los paisajes del mundo. Cuatro diseños con una textura llena de profundidad y sensaciones. Unas maderas atemporales, sobrias y elegantes para hacer del baño tu paraíso.

wood

La serie **WOOD** de ARLUX está seleccionada para aquellos que aprecian la rusticidad de la madera y desean hacer de su mueble de baño una pieza realmente personal. Las profundas marcas y nudos de estos tres diseños son realmente impresionantes y gracias a los tres tonos que KYRYA® te ofrece podrás adecuarlo a tu propio estilo.

oak

En la serie **OAK** de ARLUX pensamos en una de las maderas más ligadas al mobiliario que existe, siempre llena de variedades, los robles y sus distintas especies son esenciales en un mueble que evoca calidad y autenticidad. Hemos seleccionado para ti tres especies desde la más neutra y elegante a la más rústica y grisácea para conseguir un aspecto vintage industrial.

marble

MARBLE de ARLUX es esencia y sinceridad dos acabados clásicos inalterables y siempre de moda. Descubre las nuevas texturas de estos acabados y crea un espacio de baño que respire calidad y estilo único. **HPL BLANCO BRILLO** siempre un clásico que no puede faltar.



ARLUX

gravel

La serie **GRAVEL** de ARLUX nos transportan a los lechos pedregosos de los ríos como inspiración a estos acabados repletos de detalles y texturas. 3 acabados que combinan perfectamente en cualquier baño dando un aspecto natural y elegante. Están realizados con sistemas de alta presión para conseguir una textura y una resistencia al nivel de los estándares de calidad de nuestra gama ARLUX.



ARCR01
SOFT



ARCR03
LIGHT

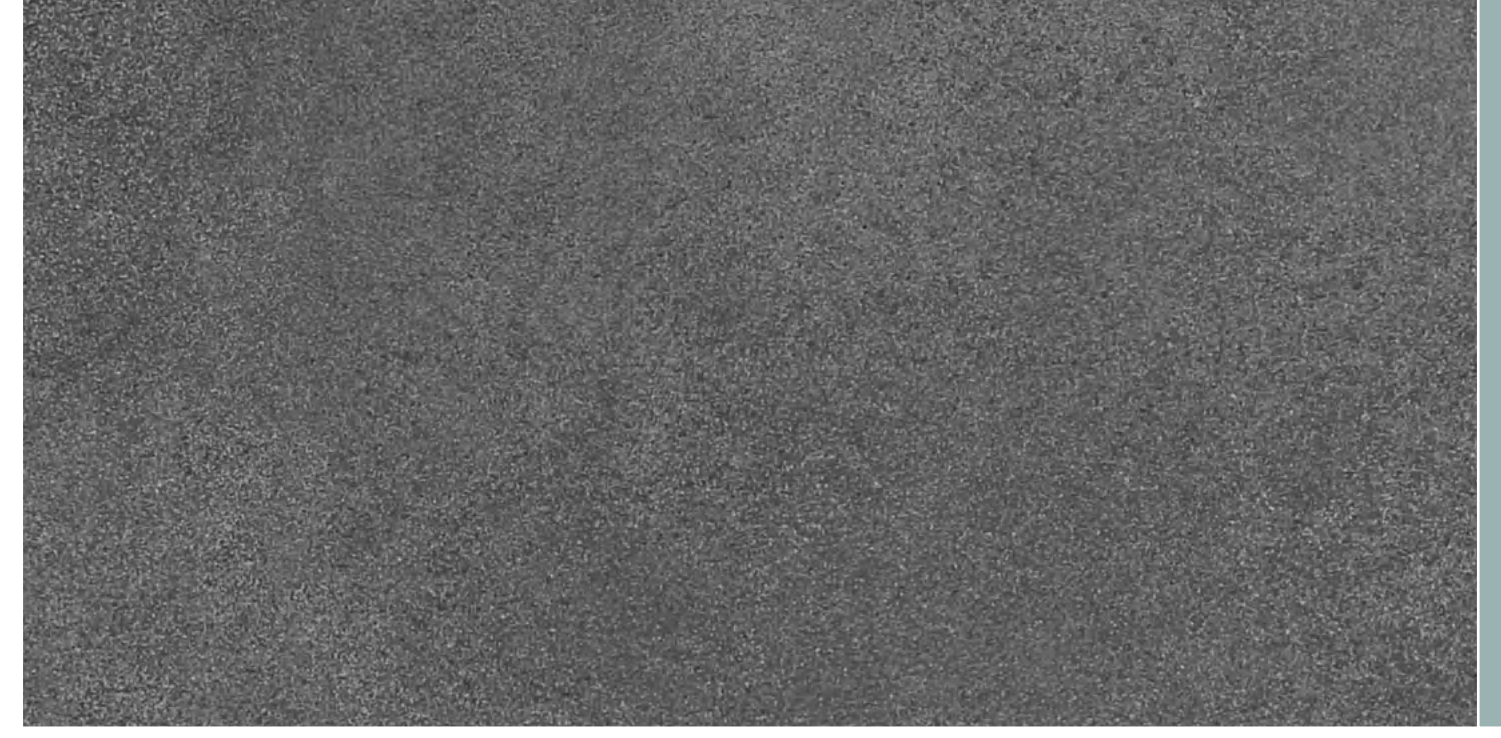

ARCR02
DARK

ARLUX

touch

La serie **TOUCH** de ARLUX está inspirada en la sinceridad material de elementos industriales para poder dar a los muebles ese aspecto tan ligado a la arquitectura de diseño. Cada acabado tiene un tacto y una textura perfectamente estudiada para conseguir esa sensación de realismo y alta calidad de acabados que desde KYRYA® te ofrecemos en nuestra gama ARLUX.



ARTO01
ROC



ARTO02
DESERT



ARTO05
TOPO

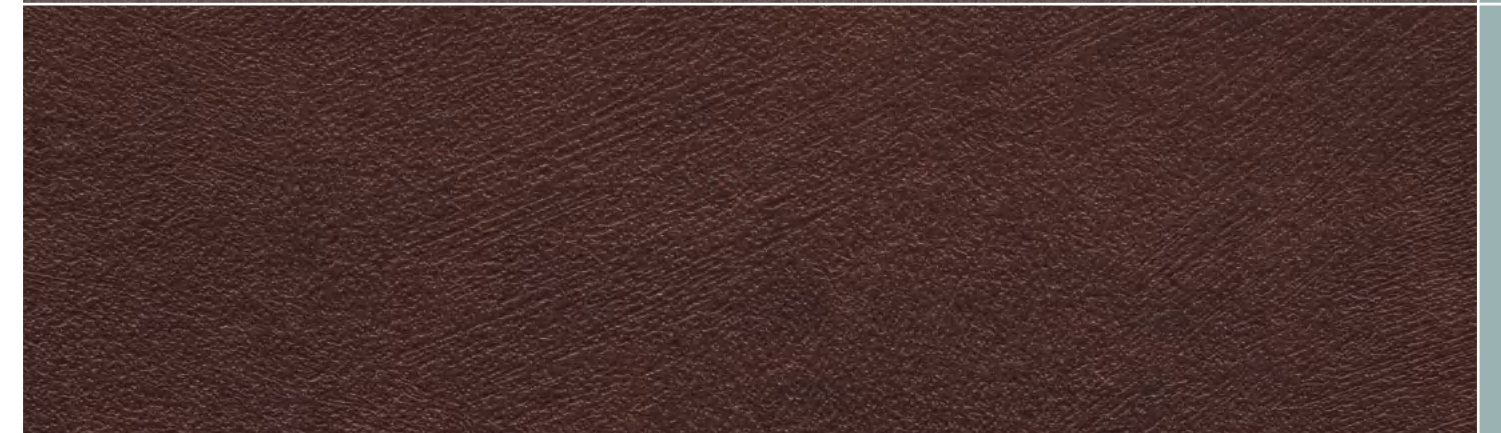

ARTO04
CORTEN

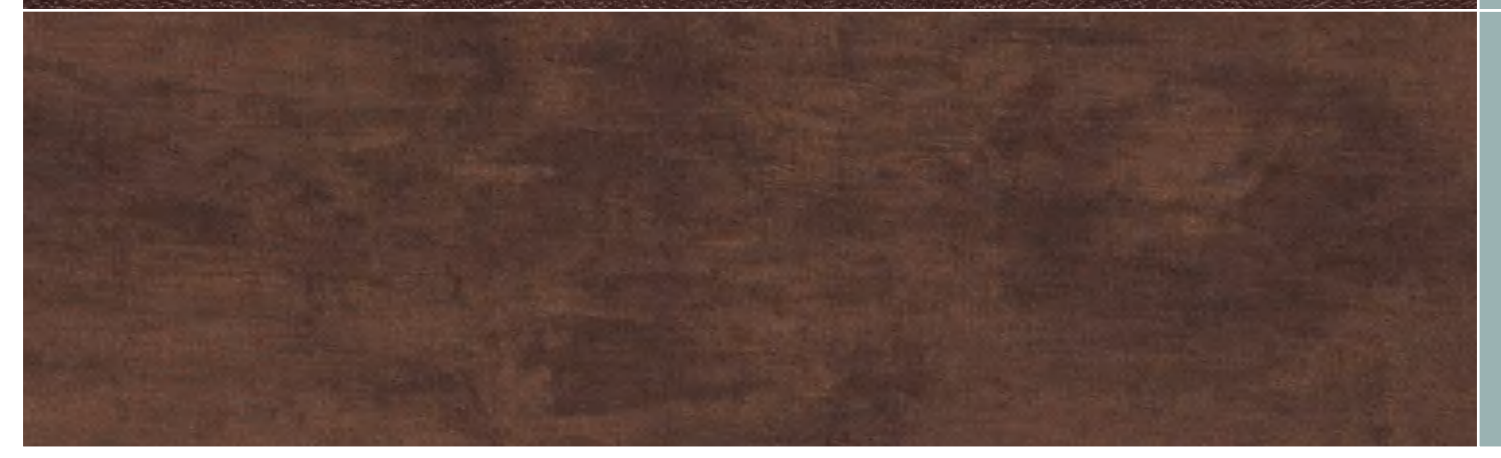

ARTO06
BRONZE

ARLUX
feel

La serie **FEEL** de ARLUX quiere transportarte a otros lugares, desde una elegante malla de fresno nos acercamos a los matices de los paisajes del mundo. Cuatro diseños con una textura llena de profundidad y sensaciones. Unas maderas atemporales, sobrias y elegantes para hacer del baño tu paraíso.

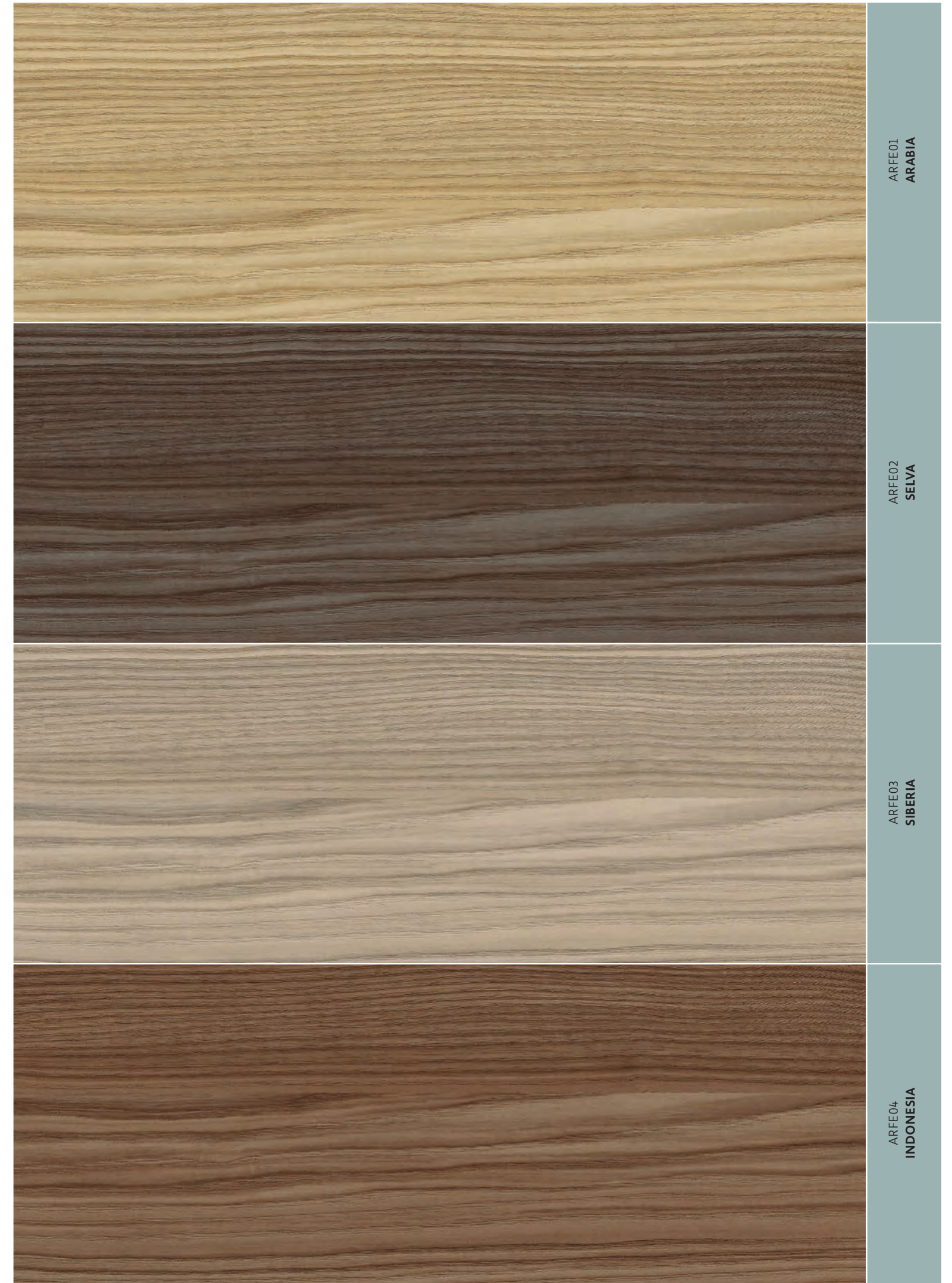

ARFE01
ARABIA

ARFE02
SELVA

ARFE03
SIBERIA

ARFE04
INDONESIA



ARLUX wood

La serie **WOOD** de ARLUX está seleccionada para aquellos que aprecian la rusticidad de la madera y desean hacer de su mueble de baño una pieza realmente personal. Las profundas marcas y nudos de estos tres diseños son realmente impresionantes y gracias a los tres tonos que KYRYA® te ofrece podrás adecuarlo a tu propio estilo.

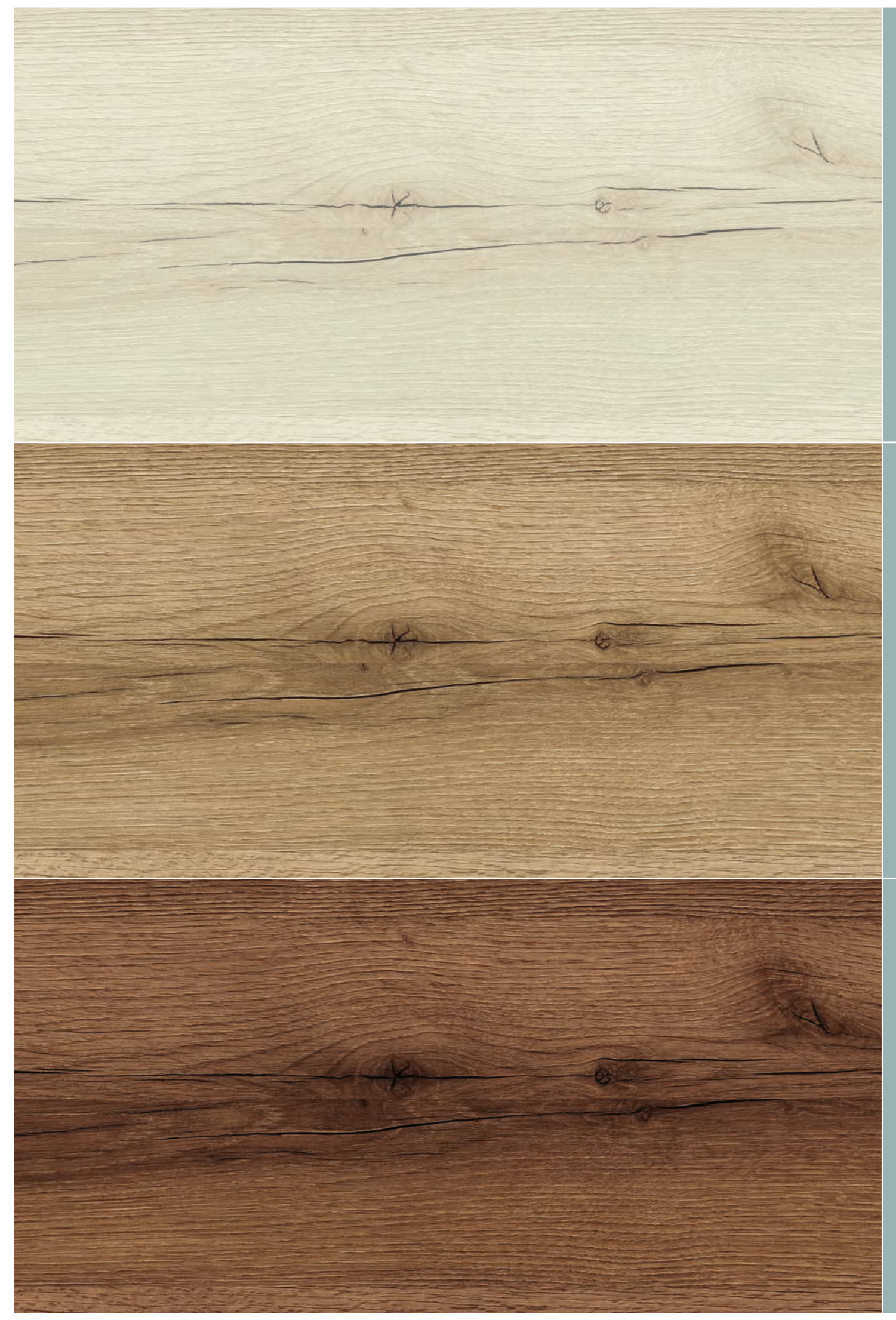

ARW008
ARTIC

ARW003
LECNO

ARW007
TABACO

ARLUX oak

En la serie **OAK** de ARLUX pensamos en una de las maderas más ligadas al mobiliario que existe, siempre llena de variedades, los robles y sus distintas especies son esenciales en un mueble que evoca calidad y autenticidad. Hemos seleccionado para ti tres especies desde la más neutra y elegante a la más rústica y grisácea para conseguir un aspecto vintage industrial.



ARRO01
OAK SIERRA



ARRO02
OAK NATUR



ARRO03
OAK CENIZA



ARRO04
OAK BRANDY

ARLUX marble

MARBLE de ARLUX es esencia y sinceridad dos acabados clásicos inalterables y siempre de moda. Descubre las nuevas texturas de estos acabados y crea un espacio de baño que respire calidad y estilo único.

HPL BLANCO BRILLO
Siempre un clásico que no puede faltar.

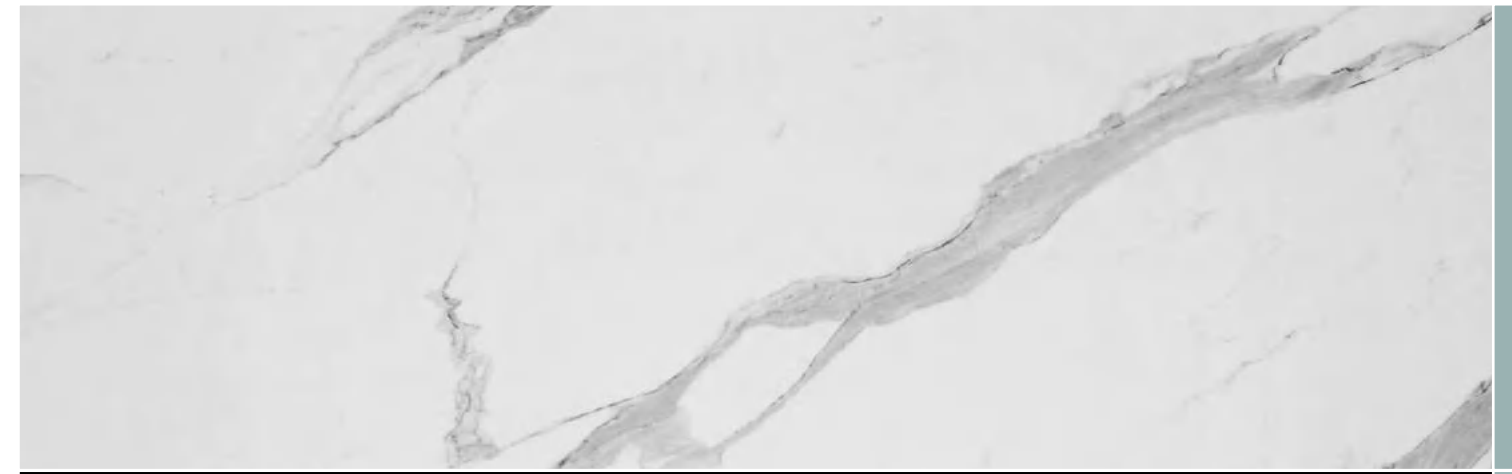

ARMA04
CALACATTA 21

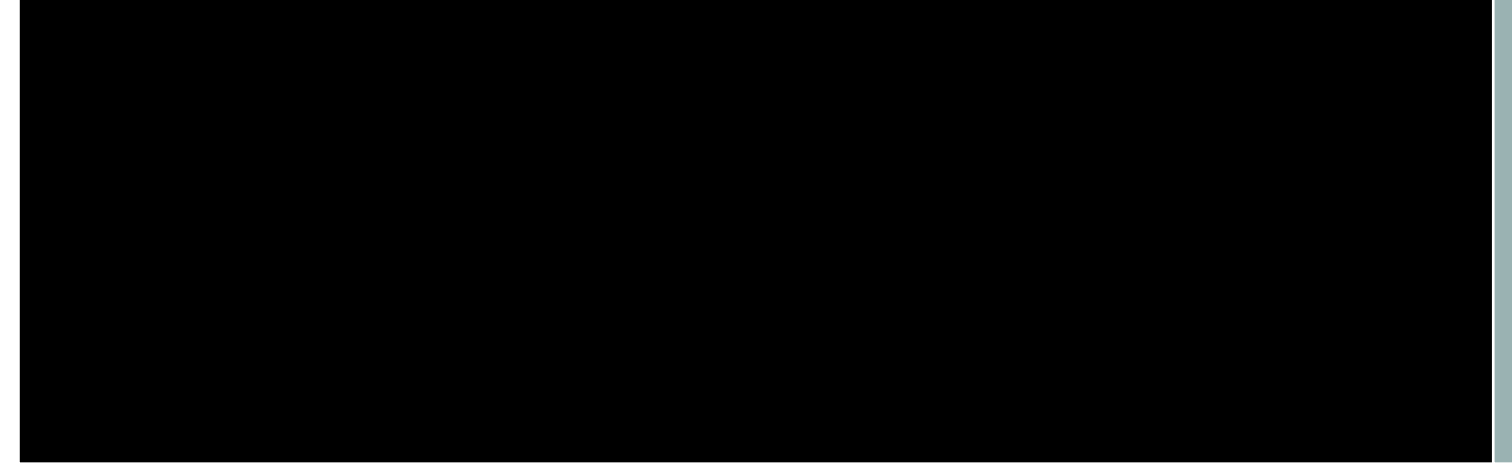

ARMA05
MARQUINA 21

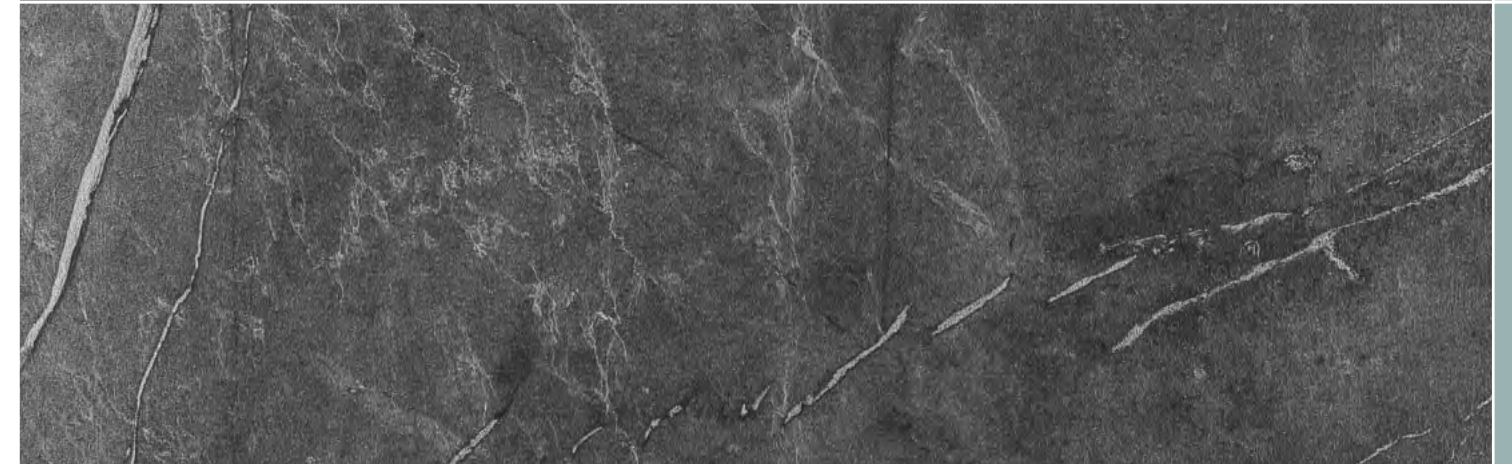

ARMA07
MYSTIC

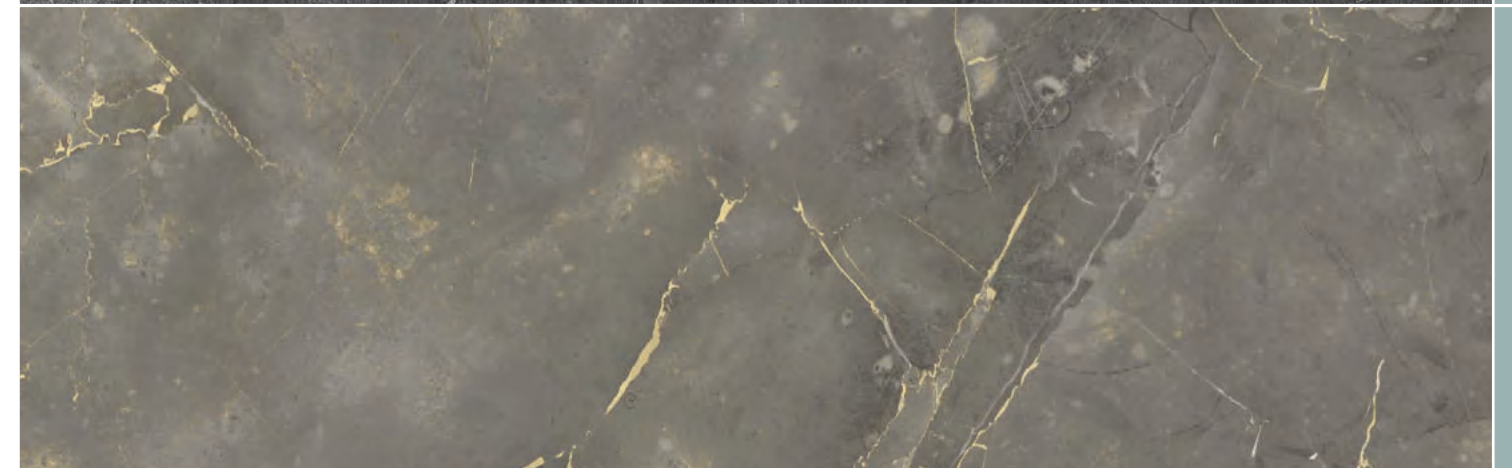

ARMA06
OASIS

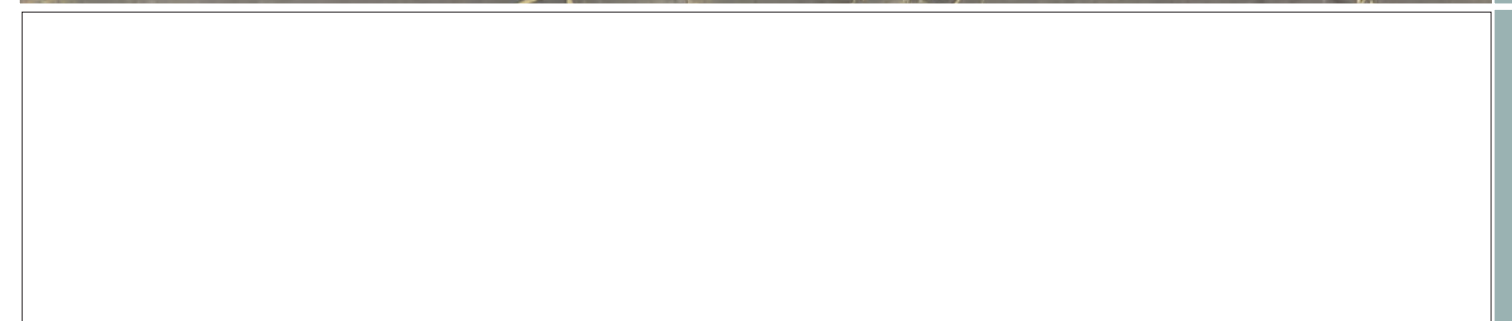

ARCO01
HPL BLANCO BRILLO

FENIX[®]

NANOTECH MATT MATERIAL
FOR INTERIOR DESIGN.
MADE IN ITALY



SUPERFICIE
MUY MATE



GRAN INTENSIDAD
DE COLOR



SUPERFICIE
HIDROFUGA



FÁCIL
DE LIMPIAR



PROPIEDAD
ANTI-BACTERIAS

FENIX[®] es un material nanotecnológico supermate para el diseño de interiores que combina elegantes soluciones estéticas y prestaciones tecnológicas de vanguardia. Material innovador creado para aplicaciones de diseño de interior por Arpa Industriale, adecuado para aplicaciones tanto verticales como horizontales. La superficie exterior de **FENIX[®]** se obtiene con la aplicación de la nanotecnología y se caracteriza por el uso resinas acrílicas que son endurecidas y fijadas a través de un proceso de Electron Beam Curing que abre un camino inédito en el mundo del diseño de interiores. Con una baja reflectancia de la luz, su superficie es extraordinariamente mate, antihuella digital, agradable y suave al tacto. Gracias al uso de la nanotecnología, **FENIX[®]** es capaz de regenerarse de posibles microarañazos superficiales mediante un proceso de reparación térmica, como indica su propio nombre.



ANTI-HUELLA
DIGITAL



RESISTENCIA
AL IMPACTO



RESISTENCIA
A QUÍMICOS



REPARACIÓN
TÉRMICA

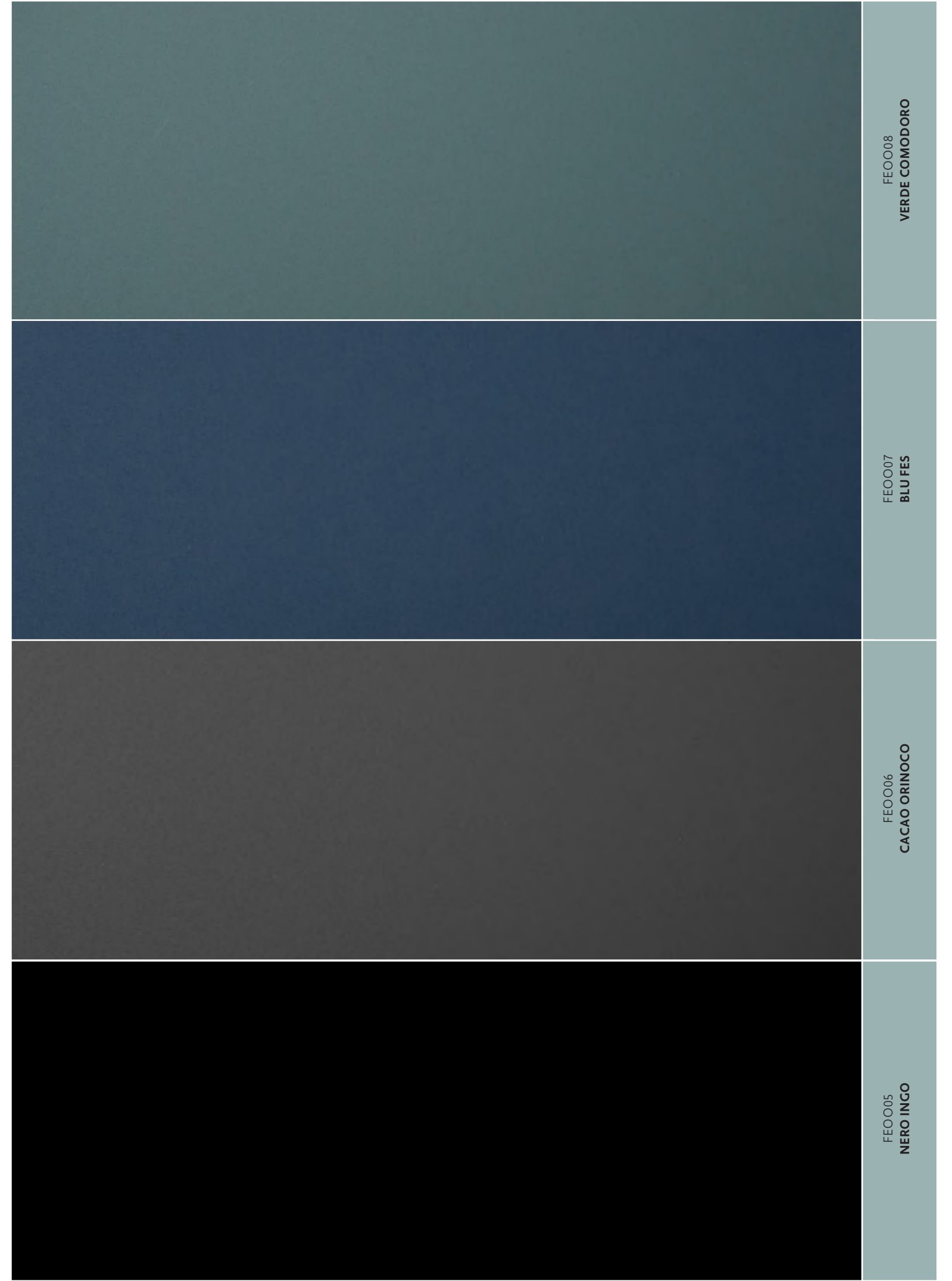
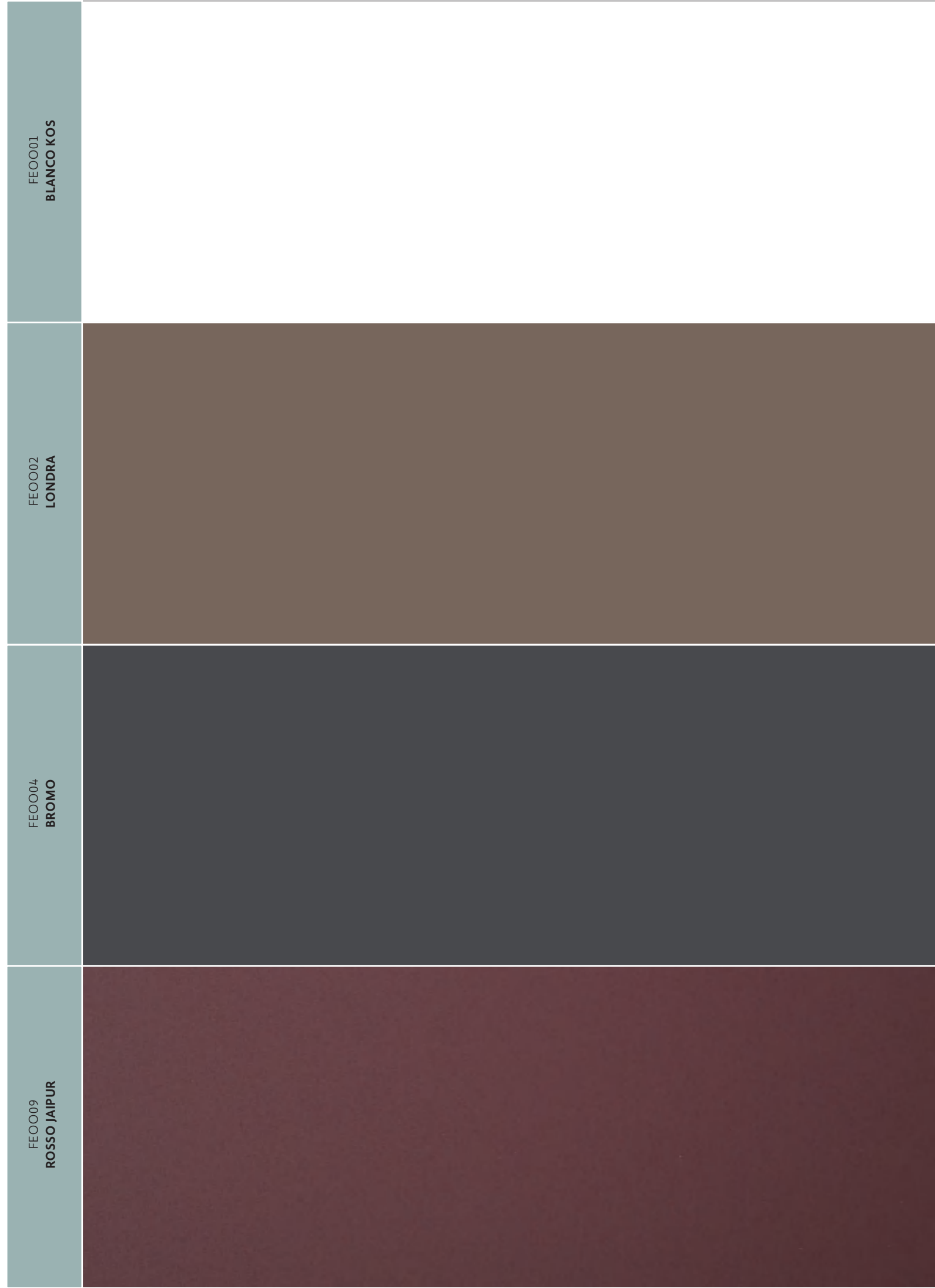

MADERA

LA PERFECCIÓN DE LA NATURALEZA

La expresión más natural en tu espacio de baño.

fresno

El **FRESNO** es una madera que nace en los márgenes húmedos de los ríos, y que se adapta a todo tipo de climas, eso la convierte en la madera resistente por excelencia para quienes buscan un acabado sólido y duradero, pero a la vez precioso y adaptable a diferentes estilos.

roble

Ya sea Duramen de color marrón-amarillo o Albura de tonos claros, el **ROBLE** es una madera que ofrece unas destacadas características de resistencia a la humedad y de alta densidad como material. La madera ideal para crear los ambientes y diseños en madera más ambiciosos.

nogal

De marrón claro a color chocolate oscuro, la albura puede tener tonalidades grisáceas e incluso amarillas. Se trata de una de las maderas oscuras favoritas, una elegancia natural que se adapta a los gustos más exquisitos.



fresno

MADERA

El **FRESNO** es una madera que nace en los márgenes húmedos de los ríos, y que se adapta a todo tipo de climas, eso la convierte en la madera resistente por excelencia para quienes buscan un acabado sólido y duradero, pero a la vez precioso y adaptable a diferentes estilos.

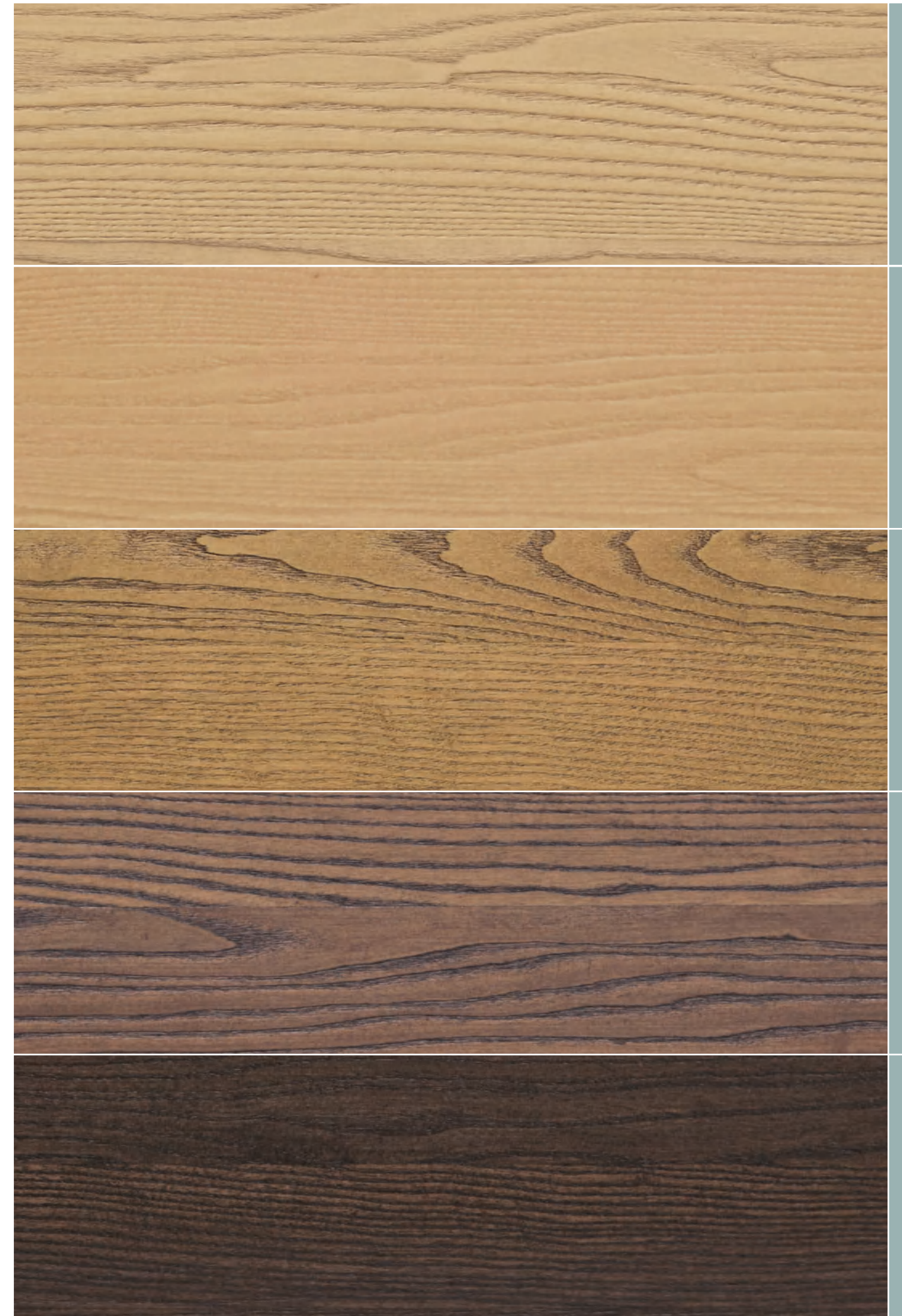

MAFO09
FRESNO VAINILLA

MAFO12
FRESNO ALMENDRA

MAFO10
FRESNO MIEL

MAFO08
FRESNO AVELLANA

MAFO11
FRESNO CHOCOLATE

roble

MADERA

Ya sea Duramen de color marrón-amarillo o Albura de tonos claros, el **ROBLE** es una madera que ofrece unas destacadas características de resistencia a la humedad y de alta densidad como material. La madera ideal para crear los ambientes y diseños en madera mas ambiciosos.

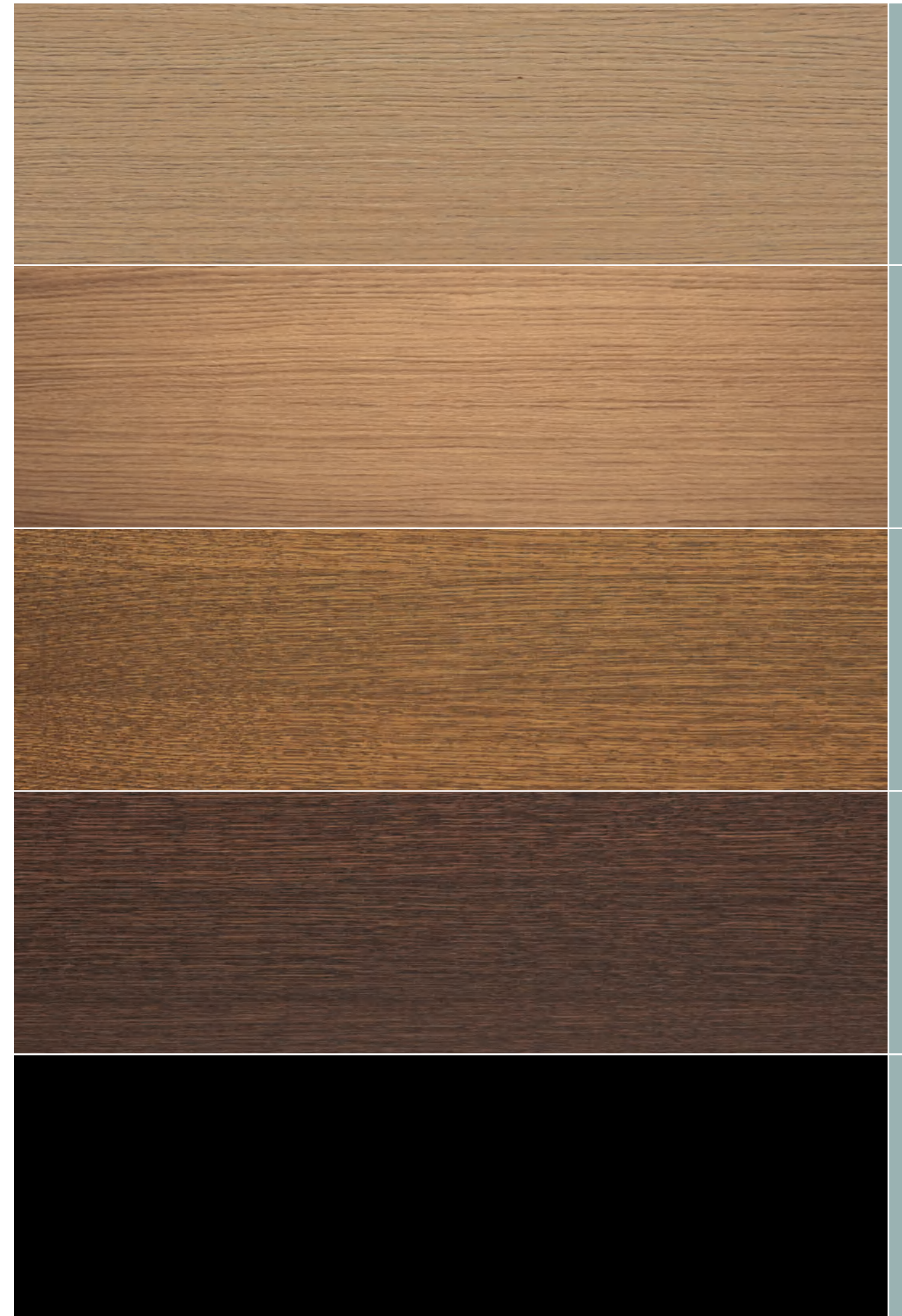

MAR006
ROBLE VAINILLA

MAR004
ROBLE ALMENDRA

MAR007
ROBLE MIEL

MAR005
ROBLE AVELLANA

MAR008
ROBLE CHOCOLATE

nogal

MADERA

De marrón claro a color chocolate oscuro, la albura puede tener tonalidades grisáceas e incluso amarillas. Se trata de una de las maderas oscuras favoritas, una elegancia natural que se adapta a los gustos mas exquisitos.

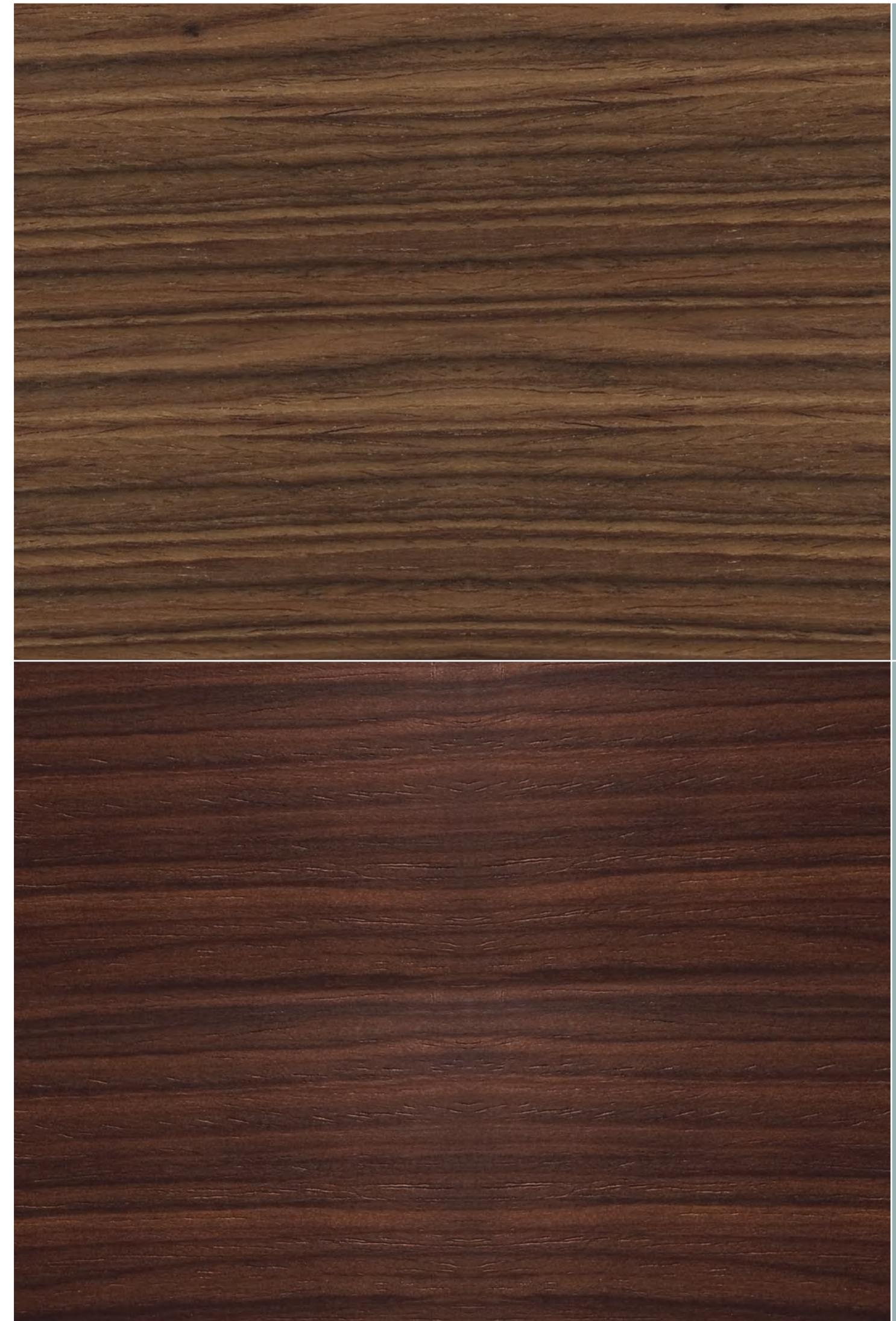

MANO01
NOGAL CLARO

MANO02
NOGAL OSCURO

LACA

UN MUNDO DE COLOR

La esencia de la artesanía en un mundo de colores a escoger.



LACA SELECT MATE



XB01



XN01

En KYRYA® hemos seleccionado 30 colores en **acabado mate**, que nos permite dar un plazo de entrega menor y coste más ajustado.

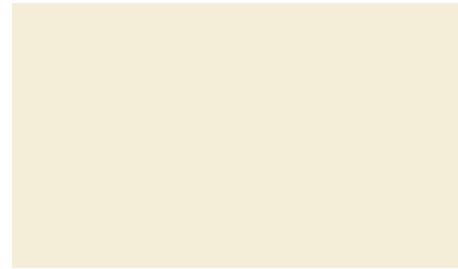

XC01



XC02



XC03



XC04



XC05

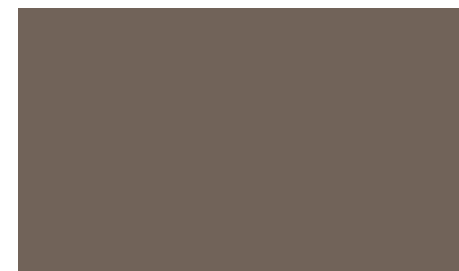

XC06



XC07



XC08

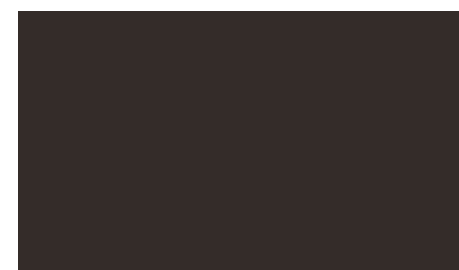

XC09



XR01



XR02



XR03



XG01



XG02



XG03



XG04



XG05



XG06



XA01



XA02



XA03



XV01



XV02



XV03



XV04



XV05



XV06

LACA RAL
(mate/pulido/metalizados)

KYRYA® ofrece la posibilidad de elegir cualquier color de la carta RAL tanto en **acabado mate** o **brillo pulido** con un incremento del 15% y del 20% en **metalizados** sobre la tarifa Laca Select Mate.



RAL



METALIZADOS

TIRADORES

	ANSO		CRISTINA		NEW STANDARD		DIANA		GINA		ELSA	
	mueble hasta	tirador medida	mueble hasta	tirador medida	mueble hasta	tirador medida	mueble hasta	tirador medida	mueble hasta	tirador medida	mueble hasta	tirador medida
horizontal (ancho**)	250	90	500	200	300	140	300	140	500	200	300	126
	>251	180	501-750	400	301-500	200	301-500	200	501-700	350	301-500	190
	-	-	>75	600	501-700	320	501-700	320	>701	600	>501	350
	-	-	-	-	>701	500	>701	500	-	-	-	-
vertical (alto**)	-	-	700	200	700	200	700	200			700	190
	-	-	701-1400	400	701-1400	320	701-1400	320			>701	350
	-	-	>1401	600	>1401	500	>1401	500			-	-

LAVABOS CERAMIC

	medidas		mueble fondo	desplazamiento		uñero
	ancho	fondo		izquierdo	derecho	
RIVER CENTRADO	610/710/810	400	393	centrado	-	P1/P2
RIVER CENTRADO	610/710/810/910/1010/1210	460	455	centrado	-	P1/P2
RIVER IZQ./DCH.	910	460	455	305	-	P1/P2
	1010	460	455	360	-	P1/P2
RIVER DOBLE	1210	460	455	305	305	P1/P2
	1410	460	455	355	355	P1/P2
CUADRO CENTRADO	610/710/810/910/1010/1210	460	455	centrado	-	P1/P2
CUADRO DOBLE	1210	460	455	305	305	P1/P2
CUADRO IZQ./DCH.	910	460	455	345	345	P1/P2
	1010	460	455	365	365	P1/P2
	1210	460	455	400	400	P1/P2
CUADRO MINI	610/710/810	360	355	centrado	-	P2

LAVABOS DURIAN®

grupo	modelo	L poza	H poza	P poza	fondo encimera	alto cajón
B	ELBA 110	111/112	11/12.5	30/33	>46	>24
B	ELBA 40	40/42	11/12.5	30/33	>46	>24
B	ELBA 50	50/52	11/12.5	30/33	>46	>24
B	ELBA 60	60/62	11/12.5	30/33	>46	>24
B	ELBA SLIM 50	50/53	8.5/10.5	30/33	>46	>24
B	FLORENCE 40	40/44	11./13	30/34	>46	>24
	Fondo uñero recto min. 47 cm.					
B	FLORENCE 50	50/54	11./13	30/34	>46	>24
	Fondo uñero recto min. 47 cm.					
B	FLORENCE 60	60/62	11./15	30/35	>46	>28
	Fondo uñero recto min. 47 cm.					
B	FLORENCE 80	80/84	14/17	30/35	>46	>28
	Fondo uñero recto min. 47 cm.					
B	FLORENCE 100	101/105	14/17	30/35	>46	>28
	Fondo uñero recto min. 47 cm.					
B	ASIS 46	46	11	29	>46	>24
A	PISA FLAT 50	49/53	12./14	31/35	>48	>26
	Fondo uñero recto min. 49 cm.					
A	PISA FLAT 59	59/63	12./14	31/35	>48	>26
	Fondo uñero recto min. 49 cm.					
A	PISA FLAT 100	100/103	12./14	31/35	>48	>26
	Fondo uñero recto min. 49 cm.					
A	FERRARA 50	50/53	11./13	31/34	>48	>24
	Con tapa o sin tapa. De no indicar mano se suministrará la tapa perimetral en la izquierda. Ubicación grifería recomendada a 17 cm. del inicio del lavabo.					
A	FERRARA 59	59/63	11./13	31/34	>48	>24
	Con tapa o sin tapa. De no indicar mano se suministrará la tapa perimetral en la izquierda. Ubicación grifería recomendada a 17 cm. del inicio del lavabo. Tapa con suplemento.					
A	SICILIA 44	45/47	11./13	32/35	>48	>26
	Fondo uñero recto min. 49 cm.					
A	SICILIA 50	49/53	11./13	32/35	>48	>26
	Fondo uñero recto min. 49 cm.					
A	SICILIA 60	60/62	11./13	32/35	>48	>26
	Fondo uñero recto min. 49 cm.					
A	MILANO 59	57/62	14/16	31/35	>48	>28
	Fondo uñero recto min. 49 cm.					
A	BOLOGNA	49/52	11./12	30/34	>48	>24
B	VENECIA	59/65	10./13	31/33	>46	>24
	Fondo uñero recto min. 47 cm.					
B	NEW SIENA	45/48	12.5/14	28/32	>46	>24
B	NEW CAPRI	50/54	10./14	29/33	>46	>24
A	NEW NAPOLI	32/36	11./13	32/36	>48	>24
	Fondo uñero recto min. 49 cm.					
C	SIENA MINI	48/49	8.5/10.5	22.5/25	>40	>24
C	TURÍN	33/35	9./10	25/27	>40	>24
	Fondo uñero recto min. 41 cm.					
C	ELBA MINI	40/42.5	10./13	25/27.5	>40	>26
	Fondo uñero recto min. 41 cm.					
C	FLORENCE MINI	40/44	11./14	21/25	>40	>26



CONDICIONES GENERALES DE VENTA

Al realizar el pedido el cliente acepta nuestras condiciones generales de venta y la tarifa de precios vigente.

PRECIOS Y PRODUCTO:

Los precios que figuran en esta tarifa son PVP recomendados, (salvo error tipográfico), pudiendo ser modificados según necesidad, IVA y montaje no incluidos. Esta tarifa anula las anteriores.

La empresa se reserva el derecho de modificar técnicamente y sin previo aviso los productos de manera parcial o totalmente que aparecen en esta tarifa con el fin de mejorarlos. Incluso su anulación.

La empresa no se responsabiliza de los posibles cambios de color o tono en ampliaciones o variaciones de pedido suministradas posteriormente.

Los acabados representados en esta tarifa pueden presentar alguna variación con respecto a la veta y color original del material.

Los mármoles son productos naturales que pueden sufrir cambios sobre la imagen en veta, textura y tonalidad, aceptando esta condición al realizar el pedido.

PEDIDOS:

Los pedidos son en firme y sólo se cursarán aquellos que se reciban por escrito y que contengan todos los datos (acabado, tirador, estructura, distribución y medidas) que sean necesarios para poder tramitar el pedido completo.

Una vez tramitado el pedido se enviará por correo electrónico una copia del mismo para su verificación, disponiendo un plazo de 24 horas para modificarlo o corregirlo.

Transcurridas las 24 horas, no se aceptarán modificaciones ni anulaciones.

Todos los pedidos recibidos se tramitan de forma individual no pudiéndose realizar la agrupación de los mismos.

Los plazos de entrega indicados en los pedidos son una fecha estimada de salida de la mercancía desde nuestras instalaciones.

La empresa no se responsabiliza de posibles indemnizaciones por el retraso total o parcial de la entrega.

CONDICIONES DE PAGO:

1. Pago adelantado a la confirmación del pedido.

2. Giro domiciliado a 30 días fecha factura.

El cliente debe de cumplir escrupulosamente las condiciones de pago pactadas. En el caso de producirse un retraso o impago, se dejara de suministrar material al cliente y la introducción de nuevos pedidos hasta que este esté al corriente del pago. De no solucionarse en el plazo de 15 días, procederemos a remitir el aviso de falta de pago a nuestra compañía aseguradora.

La mercancía es propiedad de la empresa hasta que no esté realizado el pago total de la factura correspondiente, actuando el cliente en calidad de depositario.

TRANSPORTE Y MERCANCÍA:

Los precios incluyen portes pagados para pedidos superiores a 300€ netos en la península y 500€ netos en las Islas Baleares.

Pedidos inferiores a este importe tendrán un recargo de 20€ y 40€ netos respectivamente.

La mercancía solo se entregará en la dirección de la tienda o almacén del cliente.

A la recepción de la mercancía el cliente es responsable de verificar el estado de la misma, especialmente en los productos más frágiles como espejos y encimeras, al igual que la verificación del albarán con los bultos entregados. Después de la revisión si esta todo correcto puede firmar el albarán de entrega sin reserva. **En caso de observar incidencia, duda, o no poder examinarlo adecuadamente, añadir en el albarán la frase “embalaje dañado” o “mercancía en mal estado”.**

Después de indicarlo en el albarán del transporte debe de comunicarse a la empresa acompañada de las correspondientes imágenes y la información de las piezas dañadas. La mercancía viaja asegurada, pero solo si se ha indicado reserva en la entrega, se dispone de un plazo de 24 horas para comunicar cualquier reclamación a la agencia, pasado este plazo la empresa no se responsabiliza de ningún tipo de reclamación por rotura o falta de mercancía.

La empresa no admite devoluciones, cualquier envío realizado a nuestras instalaciones sin previa autorización será rechazado y devuelto al destinatario en el mismo momento.

GARANTÍA:

Todos los productos están garantizados ante cualquier defecto de fabricación según la normativa europea vigente. La garantía se compromete a la reparación o sustitución de los elementos defectuosos.

Es importante seguir las instrucciones de montaje y que el mismo se realice por personal cualificado.

No se admiten reclamaciones de productos instalados, la instalación supone la aceptación del producto.

La garantía no cubre deterioros producidos imputables a la incorrecta instalación, manipulación o uso del mismo, ni elementos consumibles (leds, transformadores, etc.).

Queda excluida cualquier otra reclamación por parte del cliente.

Cualquier reclamación de producto debe de realizarse por escrito y acompañando la correspondiente factura de compra.

TRIBUNALES:

Al efectuar el pedido queda implícito la aceptación de todas y cada una de las condiciones generales de venta.

En caso de litigio, ambas partes se someterán a la jurisdicción de los tribunales del emisor de la factura de venta.

OBSERVACIONES

- Frentes y laterales en 19 mm.
- Cajones metálicos GRASS con freno y extracción total para muebles desde fondo 32,5 cm.
- Bisagras de puerta GRASS regulables con sistema de freno anti golpe.
- Lacados alto brillo, pulido y mate en los colores de la carta RAL +15%.
- Todos los armazones de los muebles se suministran con su propio canto.
- Todas las traseras, baldas y elementos estructurales no decorativos se suministran en Gris marengo.
- Encimeras calado standard son los modelos KYRYA*.
- Tolva metálica disponible para coqueta de ancho: 35 y 45 cm. (ver módulos tolva en pág. 43).
- Los muebles incluyen el tirador o uñero en el precio, excepto los indicados en pág. 16-29.
- Cuando el mueble va ser instalado entre 3 paredes, debe especificarse en el pedido.
- Tolerancias admitidas: Mobiliario ±2 mm. / Durian* ±3 mm. / Porcelana ±10 mm. / Pivstone* ±5 mm.
- Fondo de cajón superior, en bajos lavabo, 5 cm. inferior al resto, para facilitar la instalación (excepto vaciado sanitario).
- Bajo lavabos con cajón hasta 45 cm. de alto, incluye mecanizado sifón (escote).
- De no indicar lo contrario el mobiliario se fabrica 3 mm. en ancho y 2 mm. de fondo más pequeño respecto a la encimera, excepto muebles con frentes vitrina, que en fondo se resta 5 mm.
- Cualquier artículo no representado en esta tarifa, consultar su viabilidad.
- Las encimeras y lavabos no incluyen soportes ni válvulas.

MEDIDAS

BALDAS:

- Altos desde 40 hasta 59 cm. incluyen 1 balda.
- Altos hasta 94 cm. incluyen 2 baldas.
- Altos desde 95 cm. incluyen 3 baldas.
- Columnas desde 139 cm. incluyen 4 baldas.
- Semicolumna con puerta superior a 59 cm. incluye 1 balda.
- Semicolumna con puerta superior a 94 cm. incluye 2 baldas.

CAJONES:

- Fondo mínimo cajón metálico 32,5 cm.
- Altura mínima cajón 16 cm. (en el caso de uñero con calle o Anso, mínimo 19 cm.).
- Altura mínima cajón para lavabos 24 cm.

OPCIONES

- Otras medidas fuera de tarifa incremento 10% cada 10 cm.
- Cambio de distribución propuesta en ancho incremento 60€.
- Altura o anchura espejos incremento 10% cada 10 cm.
- Segundo mecanizado sifón (escote) incremento 38€.
- Cambio de posición o medida de tiradores incremento 30€.
- Cremallera de 3 posiciones por estante incremento 30€/módulo.
- Laca metalizada incremento 20%.
- Madera o Laca según muestra. Consultar viabilidad y precio.
- Encimeras calado no estándar incremento 90€.
- Mueble especial para lavabo de otro fabricante. Consultar viabilidad y precio.
- Puerta con espejo, incremento de 60€/unidad en altos y 90€/unidad en columnas.
- Separadores interiores cajón y cajón interior, (ver pág. 63).
- Guías cajón con cristales laterales (altura mínima cajón 30 cm.). Incremento 65€.
- Suplemento cambio a balda cristal 35€/und.
- Piezas de medidas especiales pueden tener incremento 102,6€ en concepto de embalaje.





WWW.KYRYA.ES

BUJIOL S.L.

Pol. Centrovía - Nicaragua, 6
50198 La Muela
ZARAGOZA (Spain)

(+34) 976 902 763
info@kyrya.es