

# COSMIC

SHOWERTIME

2022

PRECIOS DE VENTA AL PÚBLICO RECOMENDADOS. IVA NO INCLUIDO.  
TARIFA ORIENTATIVA VENDA AO PÚBLICO. OS PREÇOS INDICADOS ESTAO SUJETOS A IVA.



**COSMIC**



# Showertime

- 004 COSMIC
- 006 CONFIGURADOR  
CONFIGURADOR
- 008 NUESTROS VALORES  
NUESTROS VALORES
- 014 ÍNDICE POR TIPOLOGÍA DE MAMPARAS  
ÍNDICE POR TIPOLOGÍA DE MAMPARAS
- 018 ÍNDICE DE AMBIENTES  
ÍNDICE DE AMBIENTES
- 020 VIDRIOS DECORADOS Y ACABADOS METÁLICOS  
VIDRIOS DECORADOS Y ACABADOS METÁLICOS
- 022 MAMPARAS  
DIVISÓRIAS
- 022 **WALK IN BAÑERA · WALK IN BANHEIRA**
- 050 **WALK IN DUCHA · WALK IN DUCHE**
- 090 **CORREDERAS · PORTA DE CORRER**
- 178 **BATIENTES · PORTA DE ABRIR**
- 290 **PUERTAS DE PASO · PORTA DE PASO**
- 314 **SOLUCIONES ESPECIALES · SOLUÇÕES ESPECIAIS**
- 336 **MAMPARAS EN STOCK · DIVISÓRIAS EN STOCK**
  
- 356 PLATOS DE DUCHA  
PLATOS DE DUCHA
- 366 INFO Y ANEXOS TÉCNICOS  
INFO E ANEXOS TÉCNICOS
- 368 PERFILES SUPLEMENTARIOS  
PERFILES SUPLEMENTARIOS
- 369 RECAMBIOS  
PEÇAS DE REPOSIÇÃO
- 371 INSTRUCCIONES PEDIDO MAMPARA SUITE CON TOALLERO/S  
INSTRUÇÕES DE PEDIDO DIVISÓRIA SUITE COM TOALHEIRO/S
- 372 INSTRUCCIONES MAMPARAS ESPECIALES  
INSTRUÇÕES DIVISÓRIAS ESPECIAIS
- 373 SERVICIO DE MONTAJE E INSTALACIÓN  
SERVIÇO DE MONTAGEM E INSTALAÇÃO
- 374 TARIFA 2021 DE INSTALACIÓN DE MAMPARAS  
LISTA DE PREÇOS 2021 DE INSTALAÇÃO DE DIVISÓRIAS
- 375 TOMA DE MEDIDAS  
TOMADA DE MEDIDAS
- 377 CONDICIONES GENERALES DE VENTA  
CONDIÇÕES GERAIS DE VENDA
- 379 DECLARACIÓN DE CONFORMIDAD SEGÚN NORMA 14428  
DECLARACIÓN DE CONFORMIDAD SEGÚN NORMA 14428

Stock

Info

# Cosmic

La **experiencia** de más de treinta años avala a **Cosmic** como fabricante de **mamparas** y **divisorias** para el baño de calidad. La firma realiza una búsqueda constante de nuevos diseños para sorprender con **propuestas innovadoras**.

Las **mamparas**, **divisorias** y **platos de ducha** de la marca **Cosmic** destacan por su **funcionalidad**. El carácter natural de la empresa de explorar en otros sectores permite descubrir nuevos procesos y rodearse de los **mejores colaboradores**.

El resultado es un **completo catálogo** de mamparas con múltiples diseños y acabados y con un estilo inconfundiblemente **Cosmic**.

---

A **experiência** de mais de trinta anos confirma **Cosmic** como fabricante de **painéis**, **divisórias** e **bases de chuveiro** para o banho de qualidade. A empresa realiza uma pesquisa constante de novos designs para surpreender com **propostas inovadoras**.

Os **painéis** e **divisórias** da marca **Cosmic** destacam-se pela sua **funcionalidade**. O carácter natural da empresa de explorar outros setores permite descobrir **novos processos** e rodear-se dos **melhores colaboradores**.

O resultado é um **catálogo completo** de divisórias com múltiplos designs e acabamentos, com um estilo inconfundível **Cosmic**.





# Configurador web Cosmic

## Configurador web Cosmic

Nuevo configurador de mamparas disponible en [www.icosmic.com](http://www.icosmic.com)

Nuestro configurador de mamparas es una aplicación, de muy fácil usabilidad, que permite ver cómo quedaría en un ambiente de baño el sistema de mampara elegido. Toda nuestra gama está disponible en la nueva herramienta.

El acceso se realiza a través del menú principal, desplegando la pastilla **CONFIGURADOR 3D**. Hay que seleccionar la primera opción del desplegable, con el título Mamparas.

La primera pantalla permite elegir el sistema de apertura que el usuario necesite (batiente, corredera o walk-in) y a partir de aquí, escoger el modelo de mampara. A continuación, el configurador ofrece la posibilidad de decidir el acabado de perfilería, tipo de vidrio, decorado, medidas, tratamiento anti-cal Drop Free e incluso los tiradores.

En pocos minutos el usuario se podrá descargar un PDF con su configuración personal, con un precio y una referencia. Este documento se aceptará para realizar el pedido.

**¡Bienvenido al configurador de mamparas COSMIC!**

---

Novo configurador de divisórias disponível em [www.icosmic.com](http://www.icosmic.com)

O nosso configurador de divisórias é uma aplicação muito fácil de usar, que permite ver como ficaria o sistema de divisória escolhido num ambiente de banho. Toda a nossa gama está disponível na nova ferramenta.

O acesso realiza-se através do menu principal, no separador **CONFIGURADOR 3D**. É necessário selecionar a primeira opção da lista suspensa, com o título Divisórias.

O primeiro ecrã permite escolher o sistema de abertura que o utilizador necessita (batente, correção ou walk-in) e, a partir daqui, escolher o modelo de divisória. Em seguida, o configurador oferece a possibilidade de decidir o acabamento dos perfis, tipo de vidro, decoração, medidas tratamento antical Drop Free e até os puxadores.

Em poucos minutos, o utilizador poderá transferir um PDF com a sua configuração pessoal, com um preço e uma referência. Este documento será aceite para realizar a encomenda.

**Bem-vindo ao configurador de divisórias COSMIC!**



COLECCIÓN SUITE

MODELO SC7 MAMPARA DE DUCHA: 1 PUERTA CORREDERA Y 1 FIJO MÁS LATERAL A PUERTA



1) PERFILERIA



2) VIDRIO



3) DECORADOS



4) TIRADORES



5) MEDIDAS(mm)

Ancho frontal:   
(Entre 1200 y 2000mm)

Ancho lateral:   
(Entre 200 y 1200mm)

Altura: **2100mm**

6) FICHA PDF



Stock

Info

# El compromiso de Cosmic

## O compromisso de Cosmic

Cosmic destaca por ofrecer al mercado mamparas y sistemas que se convierten en piezas únicas, capaces de integrarse en cualquier espacio. El compromiso de la marca se centra en ofrecer calidad, sostenibilidad y un servicio que se adapta totalmente a las necesidades del cliente:

### Calidad probada hasta el detalle

Todos los sistemas divisorios Cosmic cumplen la normativa europea vigente UNE EN 14428, que asegura unas prestaciones de uso, seguridad y durabilidad excelentes.

### Sostenibilidad

Se cumplen estrictamente las normas ambientales en vigor y se reduce al máximo el impacto del transporte ya que se trabaja con fabricantes de vidrio próximos a la empresa.

### Servicio Integral de Instalación

Una amplia red de especialistas técnicos ofrece un completo servicio para la toma de medidas, instalación, y el mantenimiento en cualquier punto de España o Portugal. El sistema permite dar respuesta tanto a proyectos pequeños como de mayor envergadura. Además del asesoramiento personalizado, todos los productos van acompañados de un completo manual de instrucciones para su perfecta instalación, así como para un cuidado y mantenimiento apropiados.

Cosmic destaca-se por oferecer ao mercado divisórias e sistemas que se convertem em peças únicas, capazes de integrar-se em qualquer espaço. O compromisso da marca centra-se em oferecer qualidade, sustentabilidade e um serviço que se adapta totalmente às necessidades do cliente:

### Qualidade comprovada até ao último detalhe

Todos os sistemas divisorios fabricados por Cosmic cumprem a norma europeia vigente UNE EN 14428, que assegura um desempenho de uso, segurança e durabilidade excelente.

### Sustentabilidade

São cumpridas rigorosamente as normas ambientais em vigor e reduz-se ao máximo o impacto do transporte, já que se trabalha com fabricantes de vidro próximos da empresa.

### Serviço Integral de Instalação

Uma ampla rede de especialistas técnicos oferece um serviço completo para a medição, instalação e manutenção em qualquer ponto de Espanha ou Portugal. O sistema permite dar resposta tanto a projetos pequenos, como de maior envergadura. Além do aconselhamento personalizado, todos os produtos vêm acompanhados de um manual completo de instruções para a sua perfeita instalação e também para um cuidado e uma manutenção apropriados.

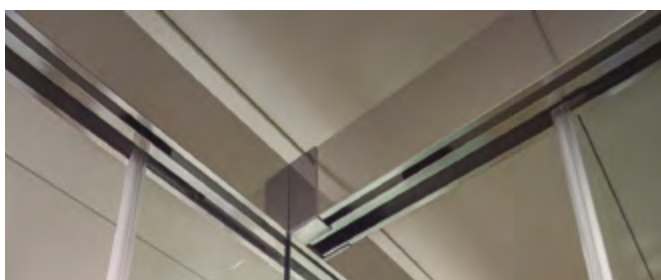



### **Innovaciones técnicas y de vanguardia**

Constante evolución en las gamas existentes y en la aplicación de nuevos avances en las novedades. Investigamos para ofrecer soluciones técnicas eficaces: como por ejemplo los nuevos rodamientos para las colecciones de correderas PLUS y TECHNIC simplificados para un mejor funcionamiento, cierre de seguridad Soft-Close, bisagras con apertura a 180 grados o a 90 grados y sistema Up & Down para facilitar la apertura.

### **Funcionalidad**

Diseño de colecciones polivalentes, especialmente a partir de la incorporación en la colección Suite de las soluciones "T", que permiten la división de una estancia en diferentes espacios, ideal para establecimientos hoteleros. Modelos reversibles para una mejor adaptación.

### **Inovações técnicas e de vanguarda**

Constante evolução nas gamas existentes e na aplicação de novos avanços nas novidades. Investigamos para oferecer soluções técnicas eficazes: como por exemplo, os novos rolagamentos para as coleções de corredeiras PLUS e TECHNIC simplificadas para um melhor funcionamento, fecho de segurança Soft-Close, dobradiças com abertura a 180° ou 90° e sistema Up & Down para facilitar a abertura.

### **Funcionalidade**

Design de coleções polivalentes, especialmente a partir da incorporação na coleção Suite das soluções "T", que permitem a divisão dos aposentos em diferentes espaços, ideal para estabelecimentos hoteleiros. Modelos reversíveis para uma melhor adaptação.



# El aval de Cosmic

## A garantía de Cosmic

Una mampara Cosmic es sinónimo de garantía. Su resistencia a la corrosión y a los ciclos de humedad convierten cada uno de los productos en un **aval**. Las estrictas pruebas a que se someten convierten los sistemas divisorios en la mejor elección posible:

Uma divisória Cosmic é sinônimo de garantia. Sua resistência à corrosão e aos ciclos de umidade tornam cada um dos produtos em **garantia**. Os testes rigorosos que eles fazem tornam possíveis os sistemas de partição:

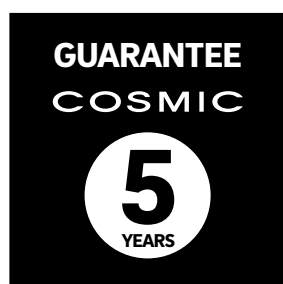

### **GARANTÍA · GARANTIA**

Cosmic garantiza por un período de 5 años todos los defectos de materia prima y fabricación. Esta garantía consiste en la sustitución de la pieza que determine su irregular funcionamiento, salvo por razones de uso inadecuado, montaje o instalación incorrectos (si el producto no ha sido instalado por el Servicio Técnico Oficial), desgaste natural, mantenimiento indebido o defectos provocados por reacciones químicas, electroquímicas o eléctricas.

garante por um período de 5 anos todos defeitos de matéria-prima e fabricação. Esta garantia consiste na substituição da peça que determina a sua operação irregular, exceto por razões de uso incorreto, instalação ou instalação incorretas (se o produto não tiver sido instalado pelo Serviço Técnico Oficial), desgaste natural, manutenção inadequada ou defeitos causados por reações químicas, eletroquímicas ou elétricas.

### **LIMPIEZA · LIMPEZA**

Los sistemas divisorios están libres de ángulos, aristas vivas, asperezas, bordes y rebabas para facilitar su acceso y su limpieza.

Os sistemas divisórios estão livres de ângulos, arestas vivas, asperezas, bordas e rebarbas para facilitar o seu acesso e limpeza.

### **RESISTENCIA A LA CORROSIÓN · RESISTÊNCIA À CORROSÃO**

Todos los componentes están constituidos por materiales resistentes a la corrosión. Tanto el recubrimiento de aluminio como la prestación de adherencia mínima cumplen las normas ISO 7599 y EN ISO 2409 respectivamente.

Todos os componentes são constituídos por materiais resistentes à corrosão. Quer o revestimento de alumínio como a prestação de aderência mínima da pintura cumprem as normas ISO 7599 e a EN ISO 2409 respetivamente.

### **RESISTENCIA A PRODUCTOS QUÍMICOS · RESISTENCIA A PRODUCTOS QUÍMICOS**

Las partes acristaladas son resistentes al uso de productos químicos. Su estética y color permanece inalterable al paso del tiempo.

As peças vitrificadas são resistentes ao uso de produtos químicos. Sua estética e cor permanecem inalteradas ao longo do tempo.

### **RESISTENCIA A LOS CICLOS DE HUMEDAD · RESISTENCIA A LOS CICLOS DE HUMEDAD**

Los sistemas divisorios se mantienen intactos a los cambios de humedad.

Os sistemas divisórios mantêm-se intactos às mudanças de humidade.

### **ENDURANCIA · RESISTÊNCIA**

Los sistemas divisorios son sometidos a un test de 20.000 ciclos de apertura y cierre que garantiza su perfecta funcionalidad.

Os sistemas divisórios são submetidos a um teste de 20.000 ciclos de abertura e fecho que garante a sua perfeita funcionalidade.

### **ESTABILIDAD · ESTABILIDADE**

El uso de vidrio templado en los sistemas divisorios asegura una mayor estabilidad, resistiendo a una energía que representa el impacto de un cuerpo humano sobre una amplia zona.

O uso de vidro temperado nos sistemas divisórios assegura uma maior estabilidade, resistindo a uma energia que representa o impacto de um corpo humano sobre uma área ampla.

### **ESTANQUEIDAD · ESTANQUICIDADE**

Cada nuevo modelo se somete a estrictas pruebas que certifican su estanqueidad. Algunos modelos de puertas batientes pueden presentar pequeñas fugas de agua a través del sistema interior de las bisagras.

Cada novo modelo é submetido a rigorosas provas que certificam a sua estanquicidade. Alguns dos modelos de portas de abrir podem apresentar pequenas fugas de água através do sistema interior as dobradiças.

# La profesionalidad de Cosmic

## O profissionalismo de Cosmic

Dar respuesta a las necesidades más universales, de forma **profesional** y anticipándose a los tiempos establecidos. La experiencia es un plus para ofrecer el mejor servicio a través de un departamento especializado con capacidad para gestionar grandes proyectos:

### Grandes proyectos

Cosmic pone a disposición de sus clientes **Contract** una división especializada para ofrecer soluciones globales en hoteles, complejos residenciales, urbanizaciones o equipamientos colectivos (culturales, deportivos, institucionales, sanitarios).

### Proveedor de las principales cadenas hoteleras

Contamos con una experiencia probada para servir grandes pedidos. Cosmic suministra proyectos a medida a grandes cadenas hoteleras como Melià, NH, H10 Catalonia, Barceló y Hotusa.

Responder às necessidades mais universais, de forma profissional e antecipando-se aos prazos estabelecidos. A experiência é um fator extra para oferecer o melhor serviço através de um departamento especializado com capacidade para gerir grandes projetos:

### Grandes projetos

Cosmic coloca à disposição dos seus clientes Contract, uma divisão especializada para oferecer soluções globais em hotéis, complexos residenciais, urbanizações ou equipamentos coletivos (culturais, desportivos, institucionais, sanitários).

### Fornecedor das principais cadeias hoteleiras

Contamos com uma experiência comprovada para satisfazer grandes pedidos. Cosmic fornece projetos por medida a grandes cadeias hoteleiras como Melià, NH, H10 Catalonia, Barceló e Hotusa.

W Barcelona  
[www.w-barcelona.com](http://www.w-barcelona.com)





Hotel NH Collection  
Köln Mediapark  
[www.nh-collection.com](http://www.nh-collection.com)



Eurostars Madrid Tower  
[www.eurostarsmadridtower.com](http://www.eurostarsmadridtower.com)



### Confianza y servicio personalizado

La división **Contract** da respuesta a las necesidades más universales del mercado actual con infinitas opciones para la personalización. El departamento se completa con un servicio técnico a disposición de los clientes que resuelve, de forma rápida y eficaz, cualquier tipo de montaje de mampara.

### Estricto cumplimiento de plazos

Cosmic cumple de forma estricta con los plazos establecidos, para agilizar los procesos de los grandes proyectos. En obras a medida, en 48 horas la empresa da respuesta sobre sus posibilidades o viabilidad.

### Confiança e serviço personalizado

A divisão **Contract** responde às necessidades mais universais do mercado atual com infinitas opções para a personalização. O departamento é complementado com um serviço técnico à disposição dos clientes que resolve, de forma rápida e eficaz, qualquer ipo de montagem de divisória.

### Cumprimento rigoroso de prazos

Cosmic cumpre de forma rigorosa os prazos estabelecidos, para agilizar os processos dos grandes projetos. Em obras à medida, a empresa dá resposta sobre as suas possibilidades ou viabilidade em 48 horas.

# Walk-in bañera

## Walk-in banheira

### supra2

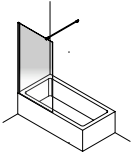

2H1  
PÁG. 34

### plus

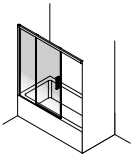

PHC  
PÁG. 36

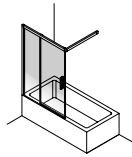

PHQ  
PÁG. 38

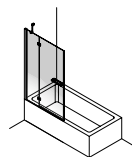

PHS  
PÁG. 40

### technic

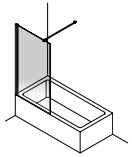

TH1  
PÁG. 42

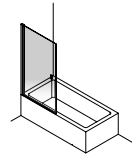

THB  
PÁG. 44

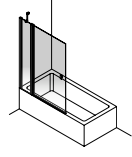

THS  
PÁG. 46

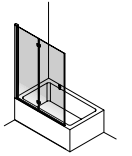

THP  
PÁG. 48

# Walk-in ducha

## Walk-in duche

### suite

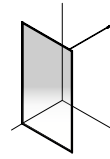

SWM  
PÁG. 68

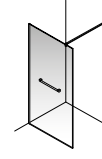

SW1  
PÁG. 70

### supra2

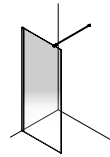

2W1  
PÁG. 72

### plus

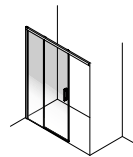

PWC  
PÁG. 74

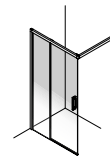

PWQ  
PÁG. 76

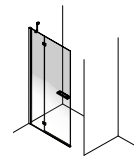

PWS  
PÁG. 78

### technic

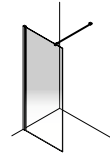

TW1  
PÁG. 80

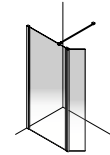

TWT  
PÁG. 82

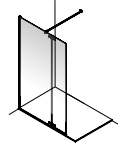

TWH  
PÁG. 84

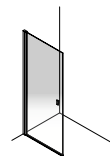

TWB  
PÁG. 86

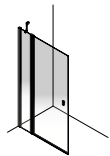

TWS  
PÁG. 88



# Correderas · Portas de correr

## mirai

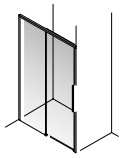

MC2 · 8C2  
PÁG. 124

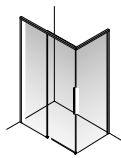

MC7 · 8C7  
PÁG. 126

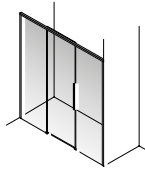

MC3 · 8C3  
PÁG. 128

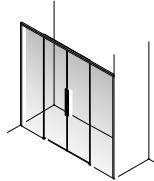

MC4 · 8C4  
PÁG. 130

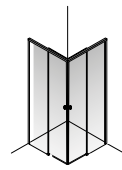

MC5  
PÁG. 132

## suite

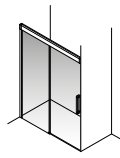

SC2  
PÁG. 134

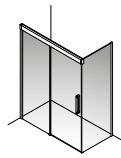

SC7  
PÁG. 136

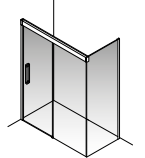

SC5  
PÁG. 138

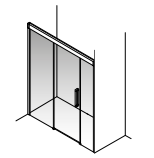

SC3  
PÁG. 140

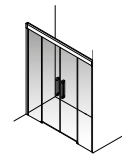

SC4  
PÁG. 142

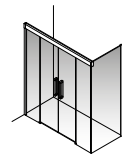

SC9  
PÁG. 144

## plus

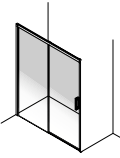

PC2  
PÁG. 146

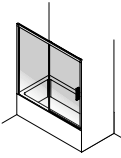

PB2  
PÁG. 146

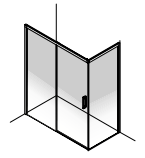

PC7  
PÁG. 148

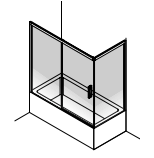

PB7  
PÁG. 148

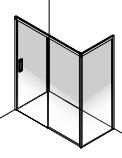

PCS  
PÁG. 150

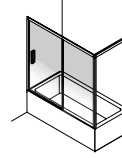

PBS  
PÁG. 150

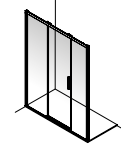

PC3  
PÁG. 152

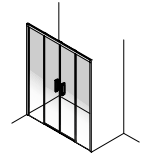

PC4  
PÁG. 154

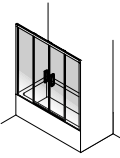

PB4  
PÁG. 154

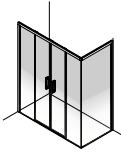

PC9  
PÁG. 156

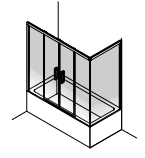

PB9  
PÁG. 156

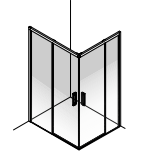

PC5  
PÁG. 158

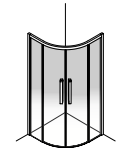

PCC  
PÁG. 160

## technic

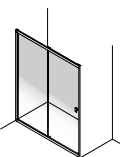

TC2  
PÁG. 162

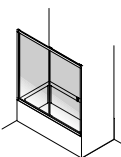

TB2  
PÁG. 162

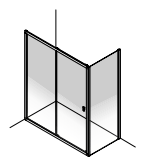

TC7  
PÁG. 164

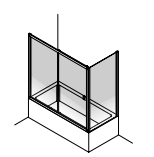

TB7  
PÁG. 164

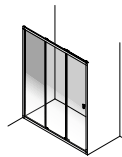

TC3  
PÁG. 166

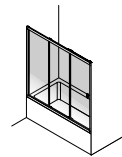

TB3  
PÁG. 166

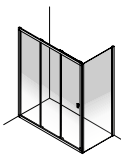

TC8  
PÁG. 168

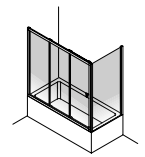

TB8  
PÁG. 168

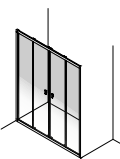

TC4  
PÁG. 170

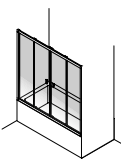

TB4  
PÁG. 170

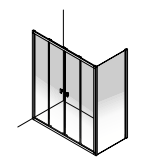

TC9  
PÁG. 172

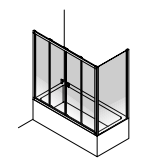

TB9  
PÁG. 172

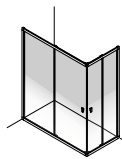

TC5  
PÁG. 174

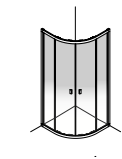

TCC · TCX  
PÁG. 176

# Batientes y plegables · Portas de abrir e dobráveis

## suite

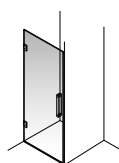

SS1  
PÁG. 210

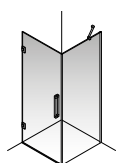

SS6  
PÁG. 212

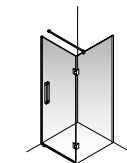

SSU  
PÁG. 214

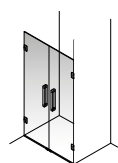

SSD  
PÁG. 216

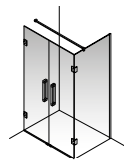

SSE  
PÁG. 218

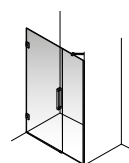

SSR  
PÁG. 220

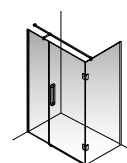

SST  
PÁG. 222

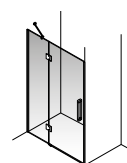

SS2  
PÁG. 224

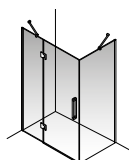

SS7  
PÁG. 226

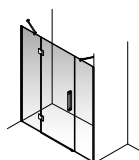

SS3  
PÁG. 228

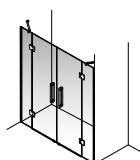

SS4  
PÁG. 230

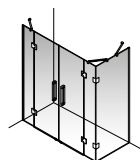

SS9  
PÁG. 232

## plus

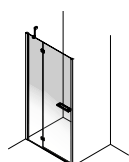

PS2  
PÁG. 234

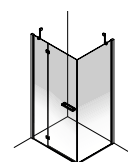

PS7  
PÁG. 236

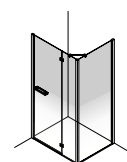

PSS  
PÁG. 238

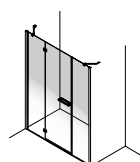

PS3  
PÁG. 240

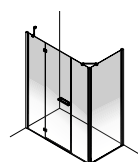

PS8  
PÁG. 242

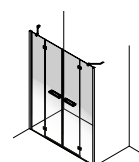

PS4  
PÁG. 244

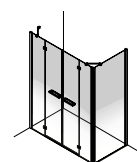

PS9  
PÁG. 246

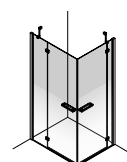

PS5  
PÁG. 248

## technic

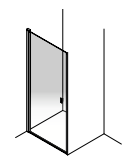

TS1  
PÁG. 250

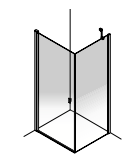

TS6  
PÁG. 252

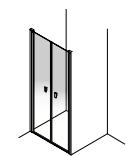

TSD  
PÁG. 254

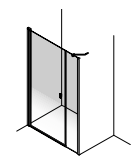

TSR  
PÁG. 256

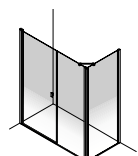

TST  
PÁG. 258

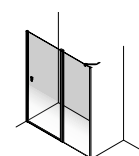

TS2  
PÁG. 260

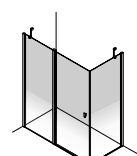

TS7  
PÁG. 262

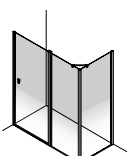

TSS  
PÁG. 264

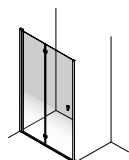

TP2  
PÁG. 266

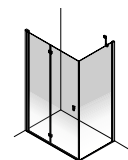

TP7  
PÁG. 268

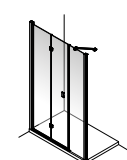

TPR  
PÁG. 270

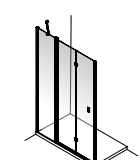

TP3  
PÁG. 272

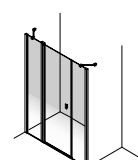

TS3  
PÁG. 274

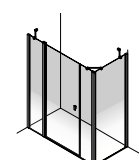

TS8  
PÁG. 276

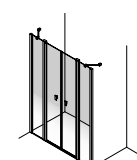

TS4  
PÁG. 278

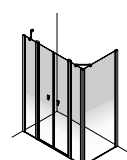

TS9  
PÁG. 280

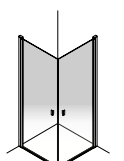

TSB  
PÁG. 282

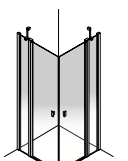

TS5  
PÁG. 284

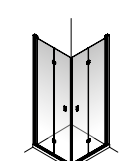

TP5  
PÁG. 286

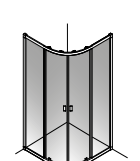

TSC · TSX  
PÁG. 288

# Puertas de paso · Portas de paso

## suite



SPP  
PÁG. 304

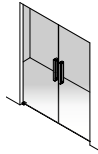

SPD  
PÁG. 306



SP2  
PÁG. 308

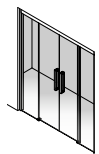

SP4  
PÁG. 310



SPB  
PÁG. 312

## Soluciones especiales · Soluções especiais

### Soluciones T

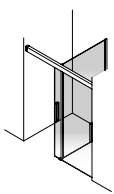

ST1  
PÁG. 328

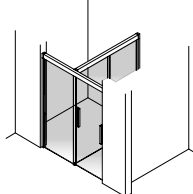

ST2  
PÁG. 330

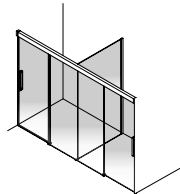

ST3  
PÁG. 332

## Stock · Stock

### Walk-in · Walk-in

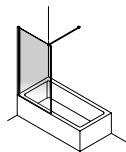

**technic**  
KH1  
PÁG. 338

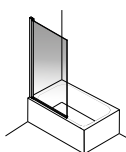

**technic**  
KHB  
PÁG. 340

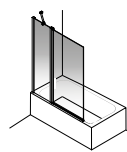

**technic**  
KHS  
PÁG. 342

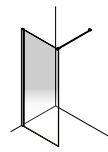

**supra2**  
KW8  
PÁG. 344

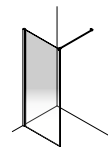

**technic**  
KW6  
PÁG. 344

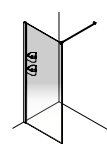

**bsmart**  
BW1  
PÁG. 346

### Correderas · Porta de correr

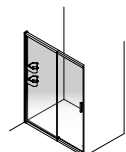

**bsmart**  
BC2  
entre paredes  
PÁG. 348

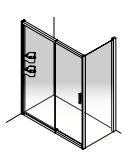

**bsmart**  
BC2  
para lateral  
PÁG. 350

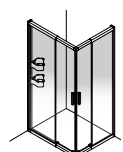

**bsmart**  
BC5  
PÁG. 352

# Ambientes • Ambientes



TECHNIC THB

PÁG. 24

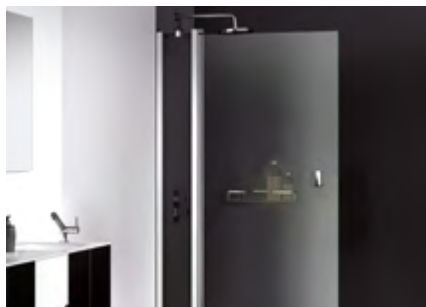

TECHNIC THS

PÁG. 28



TECHNIC THP

PÁG. 30



SUITE SWM

PÁG. 52



PLUS PWQ

PÁG. 56

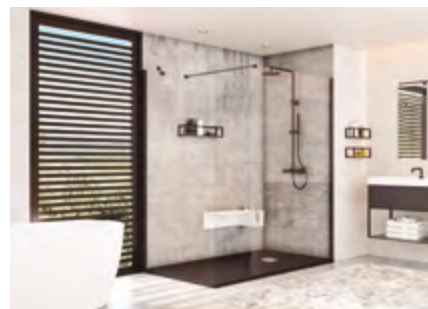

TECHNIC TW1

PÁG. 60



TECHNIC TWH

PÁG. 64



SUITE SC1

PÁG. 92



SUITE SC2

PÁG. 96



SUITE SC4

PÁG. 100



MIRAI MC7

PÁG. 102



MIRAI MC3

PÁG. 106



MIRAI MC4

PÁG. 108



PLUS PC2

PÁG. 110



PLUS PC9

PÁG. 112

# Ambientes • Ambientes



TECHNIC TC2

PÁG. 116



TECHNIC TC5

PÁG. 120

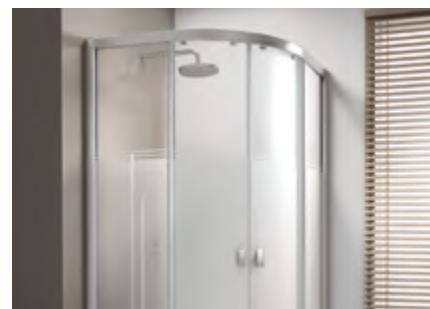

TECHNIC TCC

PÁG. 122



SUITE SBR

PÁG. 180



SUITE SS7

PÁG. 186



PLUS PB3

PÁG. 190



TECHNIC TS6

PÁG. 194



TECHNIC TP7

PÁG. 198



TECHNIC TS6

PÁG. 202

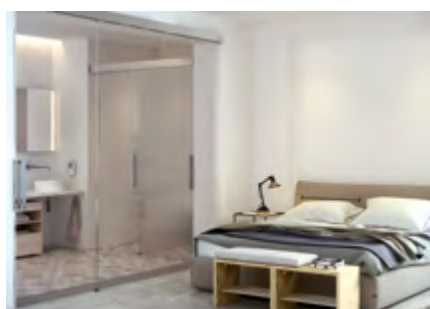

SUITE SPP

PÁG. 292



STOCK

PÁG. 290



PLATOS DE DUCHA

PÁG. 358



SOLUCIONES ESPECIALES

PÁG. 316

Stock

Info

# Vidrios, decorados y acabados metálicos

## Vidros, decorações e acabamentos metálicos

### VIDRIOS VIDROS



TRANSPARENTE  
TRANSPARENTE



AFFUMICATO  
AFFUMICATO



BRONCE  
BRONZE



MATE  
MATE

### DECORADO DECORADO

Decorado Pictor combinable con vidrio transparente, affumicato y bronce.  
Decorado Pictor combinável com vidro transparente, fumado e bronze.



PICTOR



Tratamiento anti-incrustaciones de cal Drop Free opcional en todas las mamparas. (No disponible en las puertas de acceso). El tratamiento Drop Free que se aplica en las mamparas Cosmic posee la propiedad de repeler el agua, evitando así las incrustaciones persistentes de cal, sales y suciedad. Con un simple paño húmedo, se consigue el brillo y transparencia del primer día. **IMPORTANTE:** El uso de productos como componentes abrasivos y con PH>11, pueden dañar el tratamiento Drop Free. Ciertos limpiadores "Antical" pueden crear una capa invisible en el cristal que desaparece con una limpieza con agua y jabón neutro.

Tratamento anti-depósito de calcário Drop Free opcional em todas as divisórias. O tratamento Drop Free aplicado nas divisórias da Cosmic possui a propriedade de repelir a água, evitando assim o depósito persistente de calcário, sais e sujidade. Com um simples pano húmido, consegue-se o brilho e transparência igual ao do primeiro dia. **IMPORTANTE:** O uso de componentes abrasivos e com PH>11, podem danificar o tratamento Drop Free. Certos produtos de limpeza "Antical" podem criar uma capa invisível no vidro que desaparece com uma limpeza com água e sabão neutro.

**SERIGRAFÍAS**  
SERIGRAFIAS

VIDRIO MATIFICADO  
VIDRO FOSCO

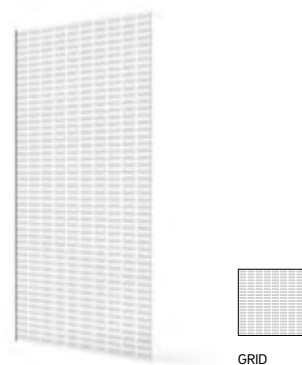
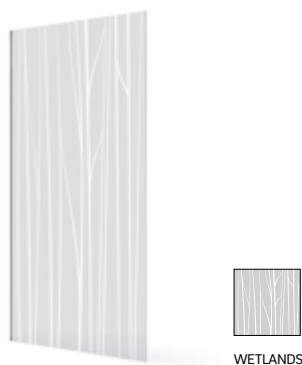
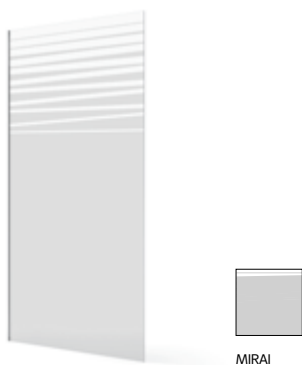

DIGITALES  
DIGITAL

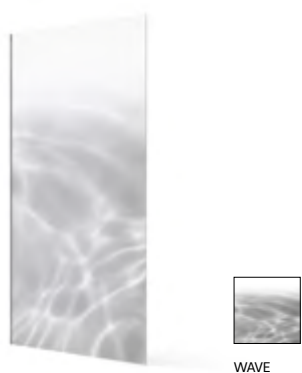
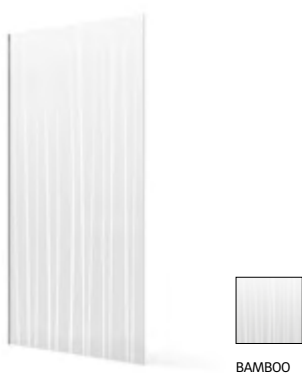

**ACABADOS METÁLICOS**  
ACABAMENTOS METÁLICOS



BRILLO  
BRILHO



MATE  
MATE



BLANCO  
BRANCO



INOX MATE  
INOX MATE

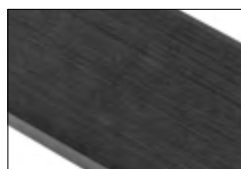

NEGRO MATE  
PRETO MATE



BRONCE MATE\*  
BRONZE MATE\*

\* solo disponible en modelo Suite SWM  
\* solo disponível em modelo Suite SWM





# Walk-in bañera

## Walk-in banheira





**Stock**

**Info**



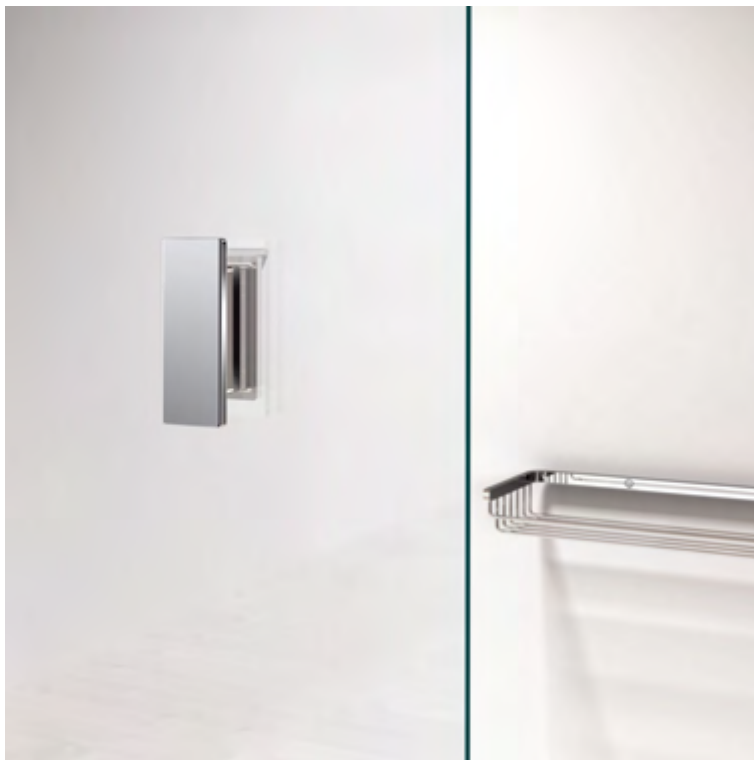

Puerta batiente con apertura a 180 grados gracias a su perfil-rótula  
Tirador de reducidas dimensiones, que da ligereza a la mampara.

Porta de Abrir com abertura a 180° graças ao seu perfil-rótula.  
Puxador de dimensões reduzidas que proporciona leveza à divisória.





Sistema Up&Down: la rótula eleva la puerta cuando se abre, consiguiendo una apertura suave, sin roces con el suelo y sin deteriorar la goma. Modelos reversibles para una mejor adaptación al espacio.

Sistema Up&Down: a rótula eleva a porta quando se abre, conseguindo uma abertura suave, sem fricção com o solo e sem deteriorar a borracha. Modelos reversíveis para uma melhor adaptação ao espaço.











Modelos plegables con bisagras. Posibilidad de disponer de un segundo tirador para facilitar la apertura (bajo pedido).

Modelos de Portas de Abrir Deslizantes. Posibilidad de disponer de un segundo puxador para facilitar a abertura (por encomenda).

# supra2

2H1 | WALK IN DE BAÑERA: 1 FIJO  
WALK IN DE BANHEIRA: 1 FIXO

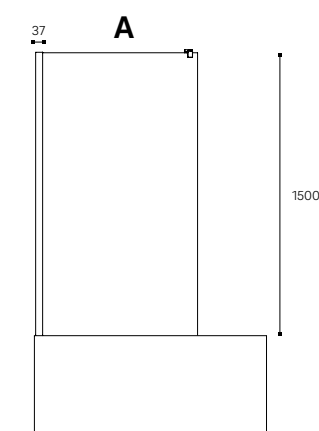

Dimensiones en mm.  
Dimensões em mm.



VIDRIO TEMPLADO  
VIDRO TEMPERADO  
**8 MM**



COMPENSACIÓN  
COMPENSAÇÃO  
**10 MM**



ALTURA MODELO DUCHA  
ALTURA MODELO DUCHE  
**1950 MM**



ALTURA MODELO BAÑERA  
ALTURA DO MODELO BANHEIRA  
**1500 MM**



MEDIDAS Y ALTURAS ESPECIALES  
MEDIDAS E ALTURAS ESPECIAIS  
(VER PÁG. / CONSULTA A PÁG. **372**)



REVERSIBLE  
REVERSÍVEL



TRATAMIENTO OPCIONAL (M)  
TRATAMENTO OPCIONAL (M)  
**45€**



Longitud máxima del tirante  
Extensão máxima do braço suporte  
**1000 MM**



MONTAJE  
MONTAJEM  
**85 € \***

\* Precio recomendado  
Código montaje **CSM03**  
Para desplazamientos  
consultar pág. **373**

\* Preço recomendado  
Código montagem **CSM03**  
Para deslocações  
consultar pág. **373**

## ACABADOS METÁLICOS ACABAMENTOS METÁLICOS



BLANCO  
BRANCO



PLATA BRILLO  
PRATA BRILHO



PLATA MATE  
PRATA MATE

## 2H1 | BAÑERA BANHEIRA

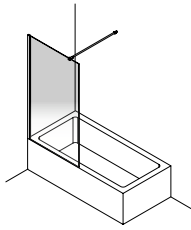

		<b>A mm</b>		
<b>PERFIL BLANCO - PLATA BRILLO - PLATA MATE</b> <b>PERFIL BRANCO - PLATA BRILHO - PRATA MATE</b>		<b>700-849</b>	<b>850-1000</b>	<b>1001-1200</b>
VIDRIO VIDRO	Transparente	301 €	336 €	370 €
	Affumicato, Bronce, Mate, Transp. decorado	376 €	420 €	463 €
	Affumicato decorado Bronce decorado Nuevos / Novos decorados *	421 €	470 €	518 €

\* Para serigrafías digitales confirmar precio con ATC. / Para serigrafias digitais confirmar preço com ATC.

### VIDRIO Y DECORADO VIDRO E DECORADO

TRANSP.



SIN DECORADO



PICTOR

AFFUMICATO



SIN DECORADO



PICTOR

BRONCE



SIN DECORADO



PICTOR

MATE



SIN DECORADO

### NUEVOS DECORADOS NOVOS DECORADOS

SERIGRAFIAS ESPECIALES



MIRAI



WETLANDS



GRID

SERIGRAFIAS DIGITALES



BAMBOO



WAVE



FOG

PHC | WALK IN DE BAÑERA: 1 PUERTA CORREDERA Y 1 FIJO  
WALK IN DE BANHEIRA: 1 PORTA DE CORRER E 1 FIXO

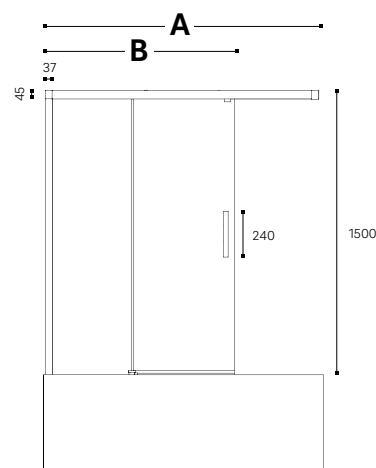

Dimensiones en mm.  
Dimensões em mm.



VIDRIO TEMPLADO  
VIDRO TEMPERADO  
**6** MM



COMPENSACIÓN  
COMPENSAÇÃO  
**15** MM



ALTURA MODELO DUCHA  
ALTURA MODELO DUCHE  
**1950** MM



ALTURA MODELO BAÑERA  
ALTURA DO MODELO BANHEIRA  
**1500** MM



MEDIDAS Y ALTURAS ESPECIALES  
MEDIDAS E ALTURAS ESPECIAIS  
(VER PÁG. / CONSULTA A PÁG. **372**)



PUERTAS DESMONTABLES,  
**FÁCIL LIMPIEZA**  
PORTAS REMOVÍVEIS,  
**FÁCIL LIMPEZA**



TRATAMIENTO OPCIONAL (M)  
TRATAMENTO OPCIONAL (M)  
**65€**



MONTAJE  
MONTAJEM  
**100 €\***

\* Precio recomendado  
Código montaje **CSM06**  
Para desplazamientos  
consultar pág. **373**

\* Preço recomendado  
Código montagem **CSM06**  
Para deslocações  
consultar pág. **373**

## ACABADOS METÁLICOS ACABAMENTOS METÁLICOS



BLANCO  
BRANCO



PLATA BRILLO  
PRATA BRILHO



PLATA MATE  
PRATA MATE

# PHC | BAÑERA BANHEIRA

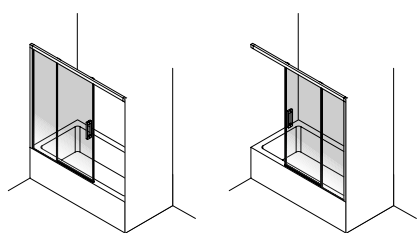

**L** IZQUIERDA  
ESQUERDA

**R** DERECHA  
DIREITA

FIJACIÓN / FIXAÇÃO

**A mm**

		1600	2000
HUECO DE LUZ FRONTAL mm		1200-1600	1601-2000
ESPAÇO LIVRE FRONTAL mm		1200-1600	1601-2000
<b>B</b>	SUMA DE LOS CRISTALES mm SOMA DOS CRISTAIS mm	1000	1200
<b>PERFIL BLANCO - PLATA BRILLO - PLATA MATE</b> <b>PERFIL BRANCO - PRATA BRILHO - PRATA MATE</b>			
VIDRIO VIDRO	Transparente	578 €	624 €
	Affumicato, Bronce, Mate, Transp. decorado	723 €	780 €
	Affumicato decorado Bronce decorado Nuevos / Novos decorados *	809 €	874 €

\* Para serigrafías digitales confirmar precio con ATC. / Para serigrafias digitais confirmar preço com ATC.

## VIDRIO Y DECORADO VIDRO E DECORADO

TRANSP.



SIN DECORADO



PICTOR

AFFUMICATO



SIN DECORADO



PICTOR

BRONCE



SIN DECORADO



PICTOR

MATE



SIN DECORADO

## NUEVOS DECORADOS NOVOS DECORADOS

SERIGRAFIAS ESPECIALES



MIRAI



WETLANDS



GRID

SERIGRAFIAS DIGITALES



BAMBOO



WAVE



FOG

PHQ | WALK IN DE BAÑERA: 1 PUERTA CORREDERA Y 1 FIJO CON GUÍA A PARED CONTRARIA  
WALK IN DE BANHEIRA: 1 PORTA DE CORRER E 1 FIXO COM GUÍA PARA PAREDE OPOSTA

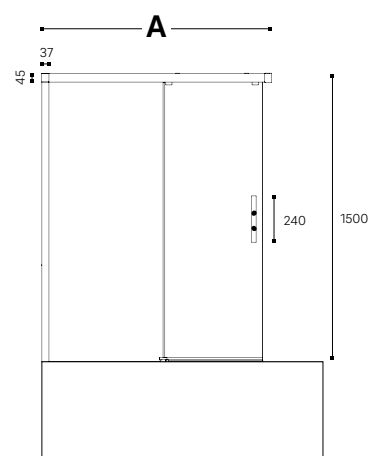

Dimensiones en mm.  
Dimensões em mm.



VIDRIO TEMPLADO  
VIDRO TEMPERADO  
**6 MM**



COMPENSAÇÃO  
COMPENSAÇÃO  
**15 MM**



ALTURA MODELO DUCHA  
ALTURA MODELO DUCHE  
**1950 MM**



ALTURA MODELO BAÑERA  
ALTURA DO MODELO BANHEIRA  
**1500 MM**



MEDIDAS Y ALTURAS ESPECIALES  
MEDIDAS E ALTURAS ESPECIAIS  
(VER PÁG. / CONSULTA A PÁG. **372**)



PUERTAS DESMONTABLES,  
**FÁCIL LIMPIEZA**  
PORTAS REMOVÍVEIS,  
**FÁCIL LIMPEZA**



TRATAMIENTO OPCIONAL (M)  
TRATAMENTO OPCIONAL (M)  
**65€**



Longitud máxima del tirante  
Extensão máxima do braço suporte  
**1000 MM**



MONTAJE  
MONTAJEM  
**100 €\***

\* Precio recomendado  
Código montaje **CSM06**  
Para desplazamientos  
consultar pág. **373**

\* Preço recomendado  
Código montagem **CSM06**  
Para deslocações  
consultar pág. **373**

## ACABADOS METÁLICOS ACABAMENTOS METÁLICOS



BLANCO  
BRANCO



PLATA BRILLO  
PRATA BRILHO



PLATA MATE  
PRATA MATE



# PHQ | BAÑERA BANHEIRA

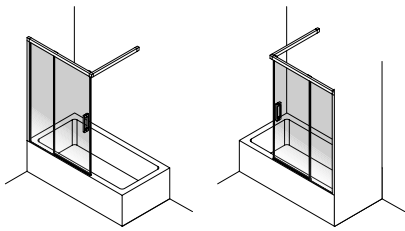

**L** IZQUIERDA  
ESQUERDA

**R** DERECHA  
DIREITA

FIJACIÓN / FIXAÇÃO

**A mm**

		1000	1200
MEDIDA FRONTAL EN mm		1000	1000
MEDIDA FRONTAL EN mm		1000	1000
SUMA DE LOS CRISTALES mm		950	1150
SOMA DOS CRISTAIS mm		950	1150
<b>PERFIL BLANCO - PLATA BRILLO - PLATA MATE</b>			
<b>PERFIL BRANCO - PRATA BRILHO - PRATA MATE</b>			
VIDRIO VIDRO	Transparente	578 €	624 €
	Affumicato, Bronce, Mate, Transp. decorado	723 €	780 €
	Affumicato decorado Bronce decorado Nuevos / Novos decorados *	809 €	874 €

\* Para serigrafías digitales confirmar precio con ATC. / Para serigrafias digitais confirmar preço com ATC.

## VIDRIO Y DECORADO VIDRO E DECORADO

TRANSP.



SIN DECORADO



PICTOR

AFFUMICATO



SIN DECORADO



PICTOR

BRONCE



SIN DECORADO



PICTOR

MATE



SIN DECORADO

## NUEVOS DECORADOS NOVOS DECORADOS

SERIGRAFIAS ESPECIALES



MIRAI



WETLANDS



GRID

SERIGRAFIAS DIGITALES



BAMBOO



WAVE



FOG

PHS | WALK IN DE BAÑERA: 1 PUERTA BATIENTE Y 1 FIJO  
WALK IN DE BANHEIRA: 1 PORTA DE ABRIR E 1 FIXO

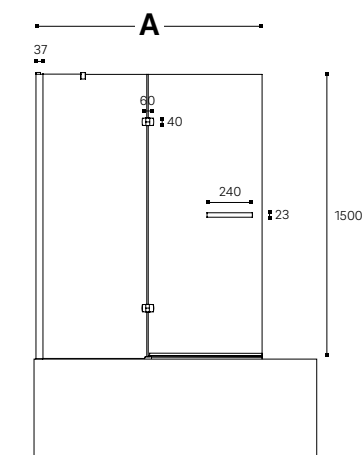

Dimensiones en mm.  
Dimensões em mm.



VIDRIO TEMPLADO  
VIDRO TEMPERADO  
**6 MM**



COMPENSAÇÃO  
COMPENSAÇÃO  
**15 MM**



ALTURA MODELO DUCHA  
ALTURA MODELO DUCHE  
**1950 MM**



ALTURA MODELO BAÑERA  
ALTURA DO MODELO BANHEIRA  
**1500 MM**



MEDIDAS Y ALTURAS ESPECIALES  
MEDIDAS E ALTURAS ESPECIAIS  
(VER PÁG. / CONSULTA A PÁG. **372**)



UP&DOWN  
UP&DOWN



TRATAMIENTO OPCIONAL (M)  
TRATAMENTO OPCIONAL (M)  
**65€**



APERTURA  
ABERTURA  
**90°**



MONTAJE  
MONTAJEM  
**90€\***

\* Precio recomendado  
Código montaje **CSM04**  
Para desplazamientos  
consultar pág. **373**

\* Preço recomendado  
Código montagem **CSM04**  
Para deslocações  
consultar pág. **373**

## ACABADOS METÁLICOS ACABAMENTOS METÁLICOS



BLANCO  
BRANCO



PLATA BRILLO  
PRATA BRILHO



PLATA MATE  
PRATA MATE

# PHS | BAÑERA BANHEIRA

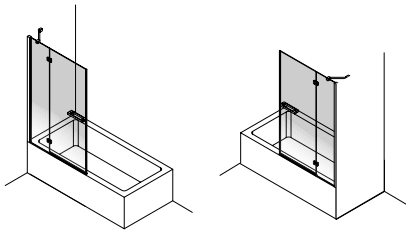

**L** IZQUIERDA  
ESQUERDA

**R** DERECHA  
DIREITA

FIJACIÓN / FIXAÇÃO

**A mm**

		800-900	901-1300
MEDIDAS DE LA PUERTA mm TAMANHO DA PORTA mm		500	600
<b>PERFIL BLANCO - PLATA BRILLO - PLATA MATE</b> <b>PERFIL BRANCO - PRATA BRILHO - PRATA MATE</b>			
VIDRIO VIDRO	Transparente	422 €	457 €
	Affumicato, Bronce, Mate, Transp. decorado	528 €	571 €
	Affumicato decorado Bronce decorado Nuevos / Novos decorados *	591 €	640 €

\* Para serigrafías digitales confirmar precio con ATC. / Para serigrafias digitais confirmar preço com ATC.

## VIDRIO Y DECORADO VIDRO E DECORADO



## NUEVOS DECORADOS NOVOS DECORADOS



Stock

Info



TH1

WALK IN DE BAÑERA: 1 FIJO  
WALK IN DE BANHEIRA: 1 FIXO

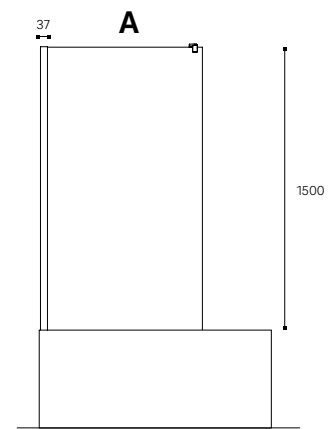

Dimensiones en mm.  
Dimensões em mm.



VIDRIO TEMPLADO  
VIDRO TEMPERADO  
**6** MM



COMPENSAÇÃO  
COMPENSAÇÃO  
**15** MM



ALTURA MODELO DUCHA  
ALTURA MODELO DUCHE  
**1950** MM



ALTURA MODELO BAÑERA  
ALTURA DO MODELO BANHEIRA  
**1500** MM



MEDIDAS Y ALTURAS ESPECIALES  
MEDIDAS E ALTURAS ESPECIAIS  
(VER PÁG. / CONSULTA A PÁG. **372**)



REVERSIBLE  
REVERSÍVEL



TRATAMIENTO OPCIONAL (M)  
TRATAMENTO OPCIONAL (M)  
**45€**



Longitud máxima del tirante  
Extensão máxima do braço suporte  
**1000** MM



MONTAJE  
MONTAJEM  
**85 € \***

\* Precio recomendado  
Código montaje **CSM03**  
Para desplazamientos  
consultar pág. **373**

\* Preço recomendado  
Código montagem **CSM03**  
Para deslocações  
consultar pág. **373**

## ACABADOS METÁLICOS ACABAMENTOS METÁLICOS



BLANCO  
BRANCO



PLATA BRILLO  
PRATA BRILHO



PLATA MATE  
PRATA MATE



NEGRO MATE  
PRETO MATE

# TH1 | BAÑERA BANHEIRA

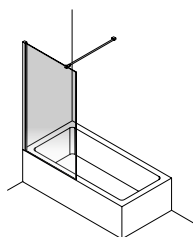

		<b>A mm</b>	
		<b>600-800</b>	<b>801-1000</b>
<b>PERFIL BLANCO - PLATA BRILLO - PLATA MATE</b>			
<b>PERFIL BRANCO - PRATA BRILHO - PRATA MATE</b>			
VIDRIO VIDRO	Transparente	267 €	301 €
	Affumicato, Bronce, Mate, Transp. decorado	334 €	376 €
	Affumicato decorado Bronce decorado Nuevos / Novos decorados *	374 €	421 €
<b>PERFIL NEGRO MATE</b>			
<b>PERFIL PRETO MATE</b>			
VIDRIO VIDRO	Transparente	319 €	360 €
	Affumicato, Bronce, Mate, Transp. decorado	399 €	450 €
	Affumicato decorado Bronce decorado Nuevos / Novos decorados *	447 €	504 €

\* Para serigrafías digitales confirmar precio con ATC. / Para serigrafias digitais confirmar preço com ATC.

## VIDRIO Y DECORADO VIDRO E DECORADO

TRANSP.	AFFUMICATO	BRONCE	MATE
SIN DECORADO	SIN DECORADO	SIN DECORADO	SIN DECORADO
PICTOR	PICTOR	PICTOR	

## NUEVOS DECORADOS NOVOS DECORADOS

SERIGRAFÍAS ESPECIALES		SERIGRAFÍAS DIGITALES	
MIRAI	WETLANDS	BAMBOO	WAVE
GRID		FOG	



THB | WALK IN DE BAÑERA: 1 PUERTA BATIENTE  
WALK IN DE BANHEIRA: 1 PORTA DE ABRIR

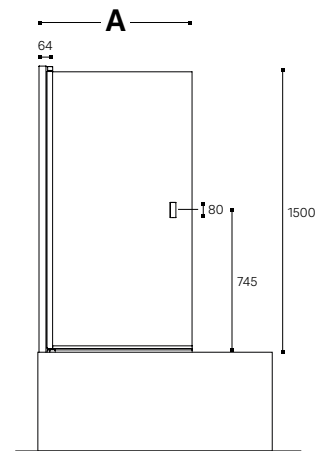

Dimensiones en mm.  
Dimensões em mm.



VIDRIO TEMPLADO  
VIDRO TEMPERADO  
**6 MM**



COMPENSACIÓN  
COMPENSAÇÃO  
**15 MM**



ALTURA MODELO DUCHA  
ALTURA MODELO DUCHE  
**1950 MM**



ALTURA MODELO BAÑERA  
ALTURA DO MODELO BANHEIRA  
**1500 MM**



APERTURA  
ABERTURA  
**180°**



MEDIDAS Y ALTURAS ESPECIALES  
MEDIDAS E ALTURAS ESPECIAIS  
(VER PÁG. / CONSULTA A PÁG. **372**)



REVERSIBLE  
REVERSÍVEL



UP&DOWN  
UP&DOWN



TRATAMIENTO OPCIONAL (M)  
TRATAMENTO OPCIONAL (M)  
**45€**



MONTAJE  
MONTAJEM  
**85 € \***

\* Precio recomendado  
Código montaje **CSM03**  
Para desplazamientos  
consultar pág. **373**

\* Preço recomendado  
Código montagem **CSM03**  
Para deslocações  
consultar pág. **373**

## ACABADOS METÁLICOS ACABAMENTOS METÁLICOS



BLANCO  
BRANCO



PLATA BRILLO  
PRATA BRILHO



PLATA MATE  
PRATA MATE

# THB | BAÑERA BANHEIRA

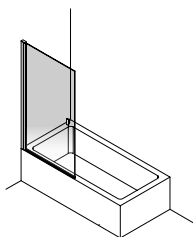

		<b>A mm</b>	
		600-800	801-1000
<b>PERFIL BLANCO - PLATA BRILLO - PLATA MATE</b>			
<b>PERFIL BRANCO - PRATA BRILHO - PRATA MATE</b>			
<b>VIDRIO VIDRO</b>	Transparente	336 €	370 €
	Affumicato, Bronce, Mate, Transp. decorado	420 €	463 €
	Affumicato decorado Bronce decorado Nuevos / Novos decorados *	470 €	518 €

\* Para serigrafías digitales confirmar precio con ATC. / Para serigrafías digitais confirmar preço com ATC.

## VIDRIO Y DECORADO VIDRO E DECORADO

TRANSP.



SIN DECORADO



PICTOR

AFFUMICATO



SIN DECORADO



PICTOR

BRONCE



SIN DECORADO



PICTOR

MATE



SIN DECORADO

## NUEVOS DECORADOS NOVOS DECORADOS

SERIGRAFÍAS ESPECIALES



MIRAI



WETLANDS



GRID

SERIGRAFÍAS DIGITALES



BAMBOO



WAVE



FOG



THS | WALK IN DE BAÑERA: 1 PUERTA BATIENTE Y 1 FIJO  
WALK IN DE BANHEIRA: 1 PORTA DE ABRIR E 1 FIXO

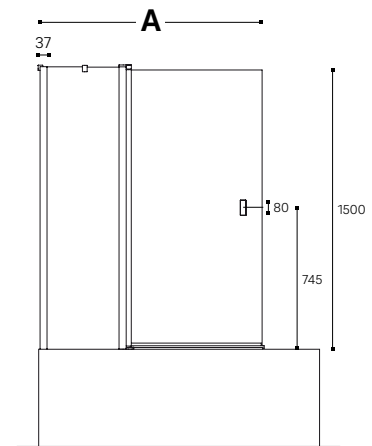

Dimensiones en mm.  
Dimensões em mm.



VIDRIO TEMPLADO  
VIDRO TEMPERADO  
**6 MM**



COMPENSACIÓN  
COMPENSAÇÃO  
**15 MM**



ALTURA MODELO DUCHA  
ALTURA MODELO DUCHE  
**1950 MM**



ALTURA MODELO BAÑERA  
ALTURA DO MODELO BANHEIRA  
**1500 MM**



APERTURA  
ABERTURA  
**180°**



MEDIDAS Y ALTURAS ESPECIALES  
MEDIDAS E ALTURAS ESPECIAIS  
(VER PÁG. / CONSULTA A PÁG. **372**)



REVERSIBLE  
REVERSÍVEL



UP&DOWN  
UP&DOWN



TRATAMIENTO OPCIONAL (M)  
TRATAMENTO OPCIONAL (M)  
**65€**



MONTAJE  
MONTAJEM  
**90 €\***

\* Precio recomendado  
Código montaje **CSM04**  
Para desplazamientos  
consultar pág. **373**

\* Preço recomendado  
Código montagem **CSM04**  
Para deslocações  
consultar pág. **373**

## ACABADOS METÁLICOS ACABAMENTOS METÁLICOS



BLANCO  
BRANCO



PLATA BRILLO  
PRATA BRILHO



PLATA MATE  
PRATA MATE



# THS | BAÑERA BANHEIRA

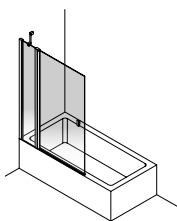

		<b>A mm</b>		
<b>PERFIL BLANCO - PLATA BRILLO - PLATA MATE PERFIL BRANCO - PRATA BRILHO - PRATA MATE</b>		<b>800-880</b>	<b>881-1200</b>	<b>1201-1400</b>
VIDRIO VIDRO	Transparente	443 €	480 €	516 €
	Affumicato, Bronce, Mate, Transp. decorado	554 €	600 €	645 €
	Affumicato decorado Bronce decorado Nuevos / Novos decorados *	620 €	672 €	722 €
MEDIDA PUERTA / MEDIDA PORTA mm		500	600	700

\* Para serigrafías digitales confirmar precio con ATC. / Para serigrafias digitais confirmar preço com ATC.

## VIDRIO Y DECORADO VIDRO E DECORADO

TRANSP.



SIN DECORADO



PICTOR

AFFUMICATO



SIN DECORADO



PICTOR

BRONCE



SIN DECORADO



PICTOR

MATE



SIN DECORADO

## NUEVOS DECORADOS NOVOS DECORADOS

SERIGRAFÍAS ESPECIALES



MIRAI



WETLANDS



GRID

SERIGRAFÍAS DIGITALES



BAMBOO



WAVE



FOG

# technic

THP | WALK IN DE BAÑERA: 2 PUERTAS PLEGABLES  
WALK IN DE BANHEIRA: 2 PORTAS DOBRÁVEIS

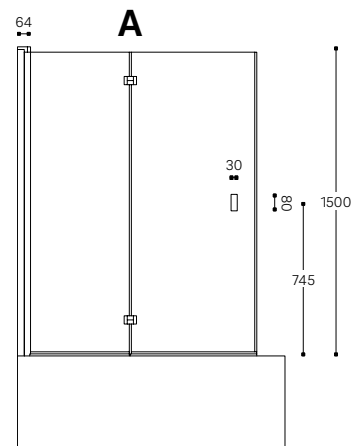

Dimensiones en mm.  
Dimensões em mm.



VIDRIO TEMPLADO  
VIDRO TEMPERADO  
6 MM



COMPENSAÇÃO  
COMPENSAÇÃO  
15 MM



ALTURA MODELO BAÑERA  
ALTURA DO MODELO BANHEIRA  
1500 MM



TRATAMIENTO OPCIONAL (M)  
TRATAMENTO OPCIONAL (M)  
45€



MEDIDAS Y ALTURAS ESPECIALES  
MEDIDAS E ALTURAS ESPECIAIS  
(VER PÁG. / CONSULTA A PÁG. 372)



APERTURA  
ABERTURA  
180°



PLEGABLE  
FOLDABLE



UP&DOWN  
UP&DOWN



MONTAJE  
MONTAJEM  
90 € \*

\* Precio recomendado  
Código montaje **CSM04**  
Para desplazamientos  
consultar pág. 373

\* Preço recomendado  
Código montagem **CSM04**  
Para deslocações  
consultar pág. 373

## ACABADOS METÁLICOS ACABAMENTOS METÁLICOS



BLANCO  
BRANCO



PLATA BRILLO  
PRATA BRILHO



PLATA MATE  
PRATA MATE

# THP | BAÑERA BANHEIRA

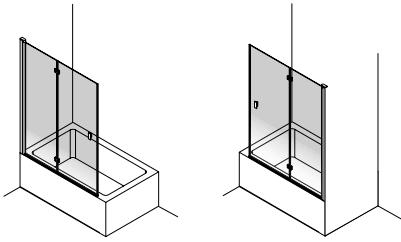

**L** IZQUIERDA  
ESQUERDA

**R** DERECHA  
DIREITA

FIJACIÓN / FIXAÇÃO

		<b>A mm</b>	
		800-1000	1001-1200
<b>PERFIL BLANCO - PLATA BRILLO - PLATA MATE</b>			
<b>PERFIL BRANCO - PRATA BRILHO - PRATA MATE</b>			
VIDRIO VIDRO	Transparente	464 €	503 €
	Affumicato, Bronce, Mate, Transp. decorado	580 €	629 €
	Affumicato decorado Bronce decorado Nuevos / Novos decorados *	650 €	704 €

\* Para serigrafías digitales confirmar precio con ATC. / Para serigrafias digitais confirmar preço com ATC.

## VIDRIO Y DECORADO VIDRO E DECORADO

TRANSP.



SIN DECORADO



PICTOR

AFFUMICATO



SIN DECORADO



PICTOR

BRONCE



SIN DECORADO



PICTOR

MATE



SIN DECORADO

## NUEVOS DECORADOS NOVOS DECORADOS

SERIGRAFÍAS ESPECIALES



MIRAI



WETLANDS



GRID

SERIGRAFÍAS DIGITALES



BAMBOO



WAVE



FOG



# Walk-in ducha

## Walk-in duche











Mampara de hoja fija enmarcada con estilizados perfiles y con barra de sujeción a pared, en acabado anodizado negro mate siguiendo las últimas tendencias de los interioristas.

Divisória de folha fixa com moldura de perfis estilizados e com suporte de fixação à parede, no acabamento preto mate seguindo as últimas tendências dos interioristas







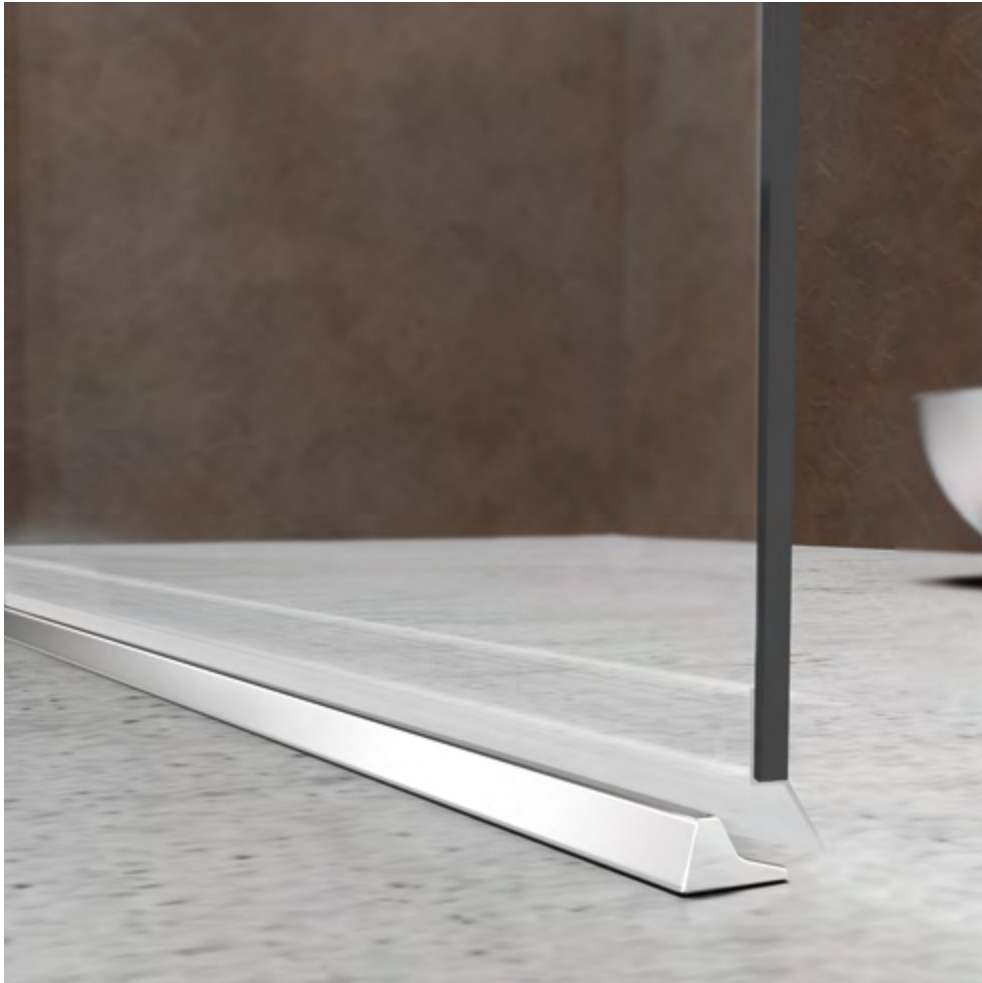

Vidrios templados de 6 mm.  
Sin guía inferior en los fijos y perfil base en las puertas

Vidros temperados de 6 mm.  
Sem guia inferior nos fixos e perfil de base nas portas.











El nuevo acabado negro mate para el perfil y el tirante da como resultado una mampara elegante y actual.

O novo acabamento preto mate para o perfil e o puxador resultam numa divisória elegante e atual.









Walk-in con práctica hoja abatible de 35 cm pensada para evitar salpicaduras manteniendo la sensación de espacio abierto.

Walk-in com folha dobrável de 35 cm pensada para evitar salpicos, mantendo a sensação de espaço aberto.

# suite

SWM | WALK IN DE DUCHA: 1 FIJO ENMARCADO  
WALK IN DE DUCHE: 1 FIXO EN MARCO

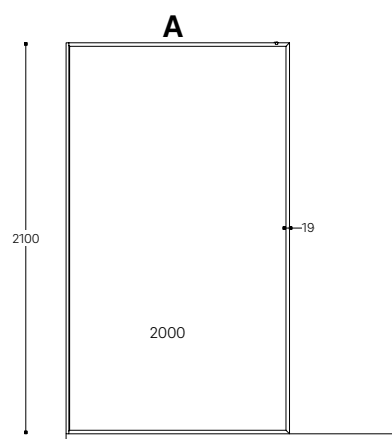

Dimensiones en mm.  
Dimensões em mm.



VIDRIO TEMPLADO  
VIDRO TEMPERADO  
**8** MM



ALTURA ESTÁNDAR  
ALTURA NORMA  
**2000** MM  
ALTURA ESPECIAL  
ALTURA ESTÁNDAR  
**HASTA 2450MM** EN PLATA BRILLO  
**HASTA 2400MM** EN LOS OTROS  
ACABADOS  
**ATÉ 2450MM** EN PRATA BRILHO  
**ATÉ 2450MM** EN OUTROS  
ACABAMENTOS



TRATAMIENTO INCLUIDO  
TRATAMENTO INCLUIDO



Longitud máxima del tirante  
Extensão máxima do braço suporte  
**1000 MM**



MEDIDAS Y ALTURAS ESPECIALES  
MEDIDAS E ALTURAS ESPECIAIS  
(VER PÁG. / CONSULTA A PÁG. **372**)



MONTAJE  
MONTAJEM  
**100 € \***

\* Precio recomendado  
Código montaje **CSM06**  
Para desplazamientos  
consultar pág. **373**

\* Preço recomendado  
Código montagem **CSM06**  
Para deslocações  
consultar pág. **373**

## ACABADOS METÁLICOS ACABAMENTOS METÁLICOS



BRILLO  
BRILHO



NEGRO MATE  
PRETO MATE



BRONZE MATE  
BRONZE MATE

## TOALLERO TOALHEIRO

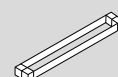

SIN TOALLERO  
SEM TOALHEIRO

400 MM

500 MM

600 MM

700 MM

# SWM | DUCHA DUCHE

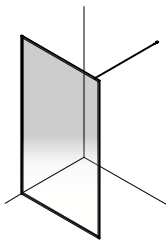

		A mm			
		800-900	901-1000	1001-1100	1101-1200
<b>PERFIL BRILLO PERFIL BRILHO</b>					
	Transparente	599 €	632 €	662 €	692 €
VIDRIO VIDRO	Affumicato, Bronce, Mate, Transp. decorado	719 €	758 €	794 €	830 €
	Affumicato decorado Bronce decorado Nuevos / Novos decorados *	809 €	853 €	894 €	934 €
	<b>PERFIL NEGRO MATE - BRONCE MATE - ORO PERFIL PRETO MATE - BRONZE MATE - OURO</b>				
	Transparente	702 €	733 €	768 €	804 €
VIDRIO VIDRO	Affumicato, Bronce, Mate, Transp. decorado	842 €	880 €	922 €	965 €
	Affumicato decorado Bronce decorado Nuevos / Novos decorados *	948 €	990 €	1.037 €	1.085 €
	<b>TOALLERO TOALHEIRO</b>				
		<b>400</b>	<b>500</b>	<b>600</b>	<b>700</b>
BRILLO BRILHO		+83 €	+94 €	+105 €	+116 €
NEGRO MATE - BRONCE MATE - ORO PRETO MATE - BRONZE MATE - OURO		+83 €	+94 €	+105 €	+116 €

\* Para serigrafías digitales confirmar precio con ATC. / Para serigrafias digitais confirmar preço com ATC.

## VIDRIO Y DECORADO VIDRO E DECORADO

TRANSP.



SIN DECORADO



PICTOR

AFFUMICATO



SIN DECORADO



PICTOR

BRONCE



SIN DECORADO



PICTOR

MATE



SIN DECORADO

## NUEVOS DECORADOS NOVOS DECORADOS

SERIGRAFIAS ESPECIALES



MIRAI



WETLANDS



GRID

SERIGRAFIAS DIGITALES



BAMBOO



WAVE



FOG

# suite

SW1 | WALK IN DE DUCHA: 1 FIJO  
WALK IN DE DUCHE: 1 FIXO

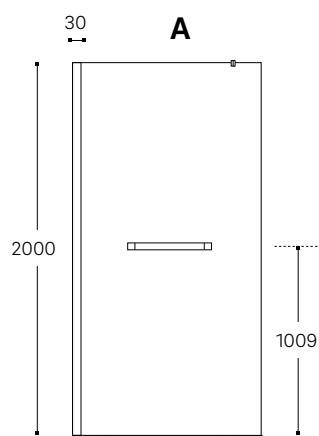

Dimensiones en mm.  
Dimensões em mm.



VIDRIO TEMPLADO  
VIDRO TEMPERADO  
**8 MM**



COMPENSACIÓN  
COMPENSAÇÃO  
**10 MM**



ALTURA ESTÁNDAR  
ALTURA NORMA  
**2000 MM**  
ALTURA ESPECIAL  
ALTURA ESTÁNDAR  
**HASTA / ATÉ 2500 MM**



Longitud máxima del tirante  
Extensão máxima do braço suporte  
**1000 MM**



MEDIDAS Y ALTURAS ESPECIALES  
MEDIDAS E ALTURAS ESPECIAIS  
**HASTA / ATÉ 2500 MM**  
(VER PÁG. / CONSULTA A PÁG. **372**)



TRATAMIENTO INCLUIDO  
TRATAMENTO INCLUIDO



MONTAJE  
MONTAJEM  
**100 € \***

\* Precio recomendado  
Código montaje **CSM06**  
Para desplazamientos  
consultar pág. **373**

\* Preço recomendado  
Código montagem **CSM06**  
Para deslocações  
consultar pág. **373**

## ACABADOS METÁLICOS ACABAMENTOS METÁLICOS



BRILLO  
BRILHO



NEGRO MATE  
PRETO MATE



INOX MATE  
INOX MATE

## TOALLERO TOALHEIRO

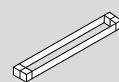

400 MM

500 MM

600 MM



# SW1 | DUCHA DUCHE

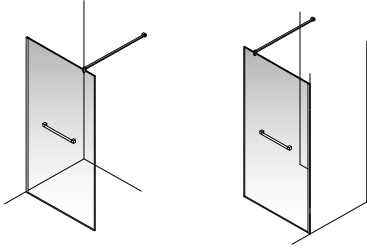

**L** IZQUIERDA  
ESQUERDA

**R** DERECHA  
DIREITA

FIJACIÓN / FIXAÇÃO

		A mm			
		800-900	901-1000	1001-1100	1101-1200
<b>PERFIL BRILLO</b> <b>PERFIL BRILHO</b>					
	Transparente	556 €	583 €	612 €	640 €
VIDRIO VIDRO	Affumicato, Bronce, Mate, Transp. decorado	667 €	700 €	734 €	768 €
	Affumicato decorado Bronce decorado Nuevos / Novos decorados *	751 €	787 €	826 €	864 €
<b>PERFIL NEGRO MATE - PERFIL INOX MATE</b> <b>PERFIL PRETO MATE - PERFIL INOX MATE</b>					
	Transparente	672 €	708 €	743 €	778 €
VIDRIO VIDRO	Affumicato, Bronce, Mate, Transp. decorado	806 €	850 €	892 €	934 €
	Affumicato decorado Bronce decorado Nuevos / Novos decorados *	907 €	956 €	1.003 €	1.050 €

		400	500	600
<b>TOALLERO</b> <b>TOALHEIRO</b>				
BRILLO BRILHO		Incluido / Incluso	+11 €	+22 €
NEGRO MATE PRETO MATE	INOX MATE INOX MATE	Incluido / Incluso	+11 €	+22 €
<b>PRECIOS SIN TOALLERO</b> <b>PREÇOS SEM TOALHEIRO</b>				
BRILLO BRILHO			-83 €	
NEGRO MATE PRETO MATE	INOX MATE INOX MATE		-83 €	

Estos precios incluyen un toallero de 400mm en el mismo acabado que el perfil de la mampara.  
Estos preços incluem um toalheiro de 400mm do mesmo acabamento do perfil da divisória.

\* Para serigrafías digitales confirmar precio con ATC. / Para serigrafías digitais confirmar preço com ATC.

## VIDRIO Y DECORADO VIDRO E DECORADO

<p>TRANSP.</p>  <p>SIN DECORADO</p>	<p>AFFUMICATO</p>  <p>SIN DECORADO</p>	<p>BRONCE</p>  <p>SIN DECORADO</p>	<p>MATE</p>  <p>SIN DECORADO</p>
<p>PICTOR</p> 	<p>PICTOR</p> 	<p>PICTOR</p> 	

## NUEVOS DECORADOS NOVOS DECORADOS

<p>SERIGRAFÍAS ESPECIALES</p>  <p>MIRAI</p>	 <p>WETLANDS</p>	<p>SERIGRAFÍAS DIGITALES</p>  <p>BAMBOO</p>	 <p>WAVE</p>
 <p>GRID</p>		 <p>FOG</p>	

# supra2

2W1

WALK IN DE DUCHA: 1 FIJO  
WALK IN DE DUCHE: 1 FIXO

PRODUCTO EN  
**Stock**



CONSULTAR PAG. 344

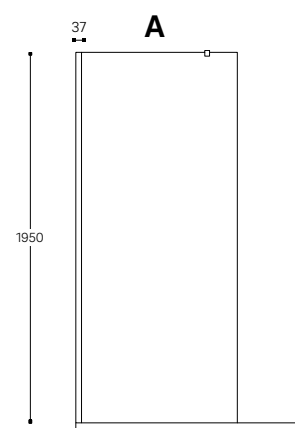

Dimensiones en mm.  
Dimensões em mm.



VIDRIO TEMPLADO  
VIDRO TEMPERADO  
**8 MM**



COMPENSAÇÃO  
COMPENSAÇÃO  
**10 MM**



ALTURA MODELO DUCHA  
ALTURA MODELO DUCHE  
**1950 MM**



TRATAMIENTO OPCIONAL (M)  
TRATAMENTO OPCIONAL (M)  
**45€**



MEDIDAS Y ALTURAS ESPECIALES  
MEDIDAS E ALTURAS ESPECIAIS  
(VER PÁG. / CONSULTA A PÁG. **372**)



REVERSIBLE  
REVERSÍVEL



Longitud máxima del tirante  
Extensão máxima do braço suporte  
**1000 MM**



MONTAJE  
MONTAJEM  
**100 €\***

\* Precio recomendado  
Código montaje **CSM06**  
Para desplazamientos  
consultar pág. **373**

\* Preço recomendado  
Código montagem **CSM06**  
Para deslocações  
consultar pág. **373**

## ACABADOS METÁLICOS ACABAMENTOS METÁLICOS



BLANCO  
BRANCO



PLATA BRILLO  
PRATA BRILHO



PLATA MATE  
PRATA MATE

## 2W1 | DUCHA DUCHE

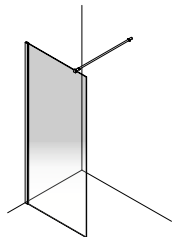

PERFIL BLANCO - PLATA BRILLO - PLATA MATE PERFIL BRANCO - PRATA BRILHO - PRATA MATE		A mm			
		700-849	850-999	1000-1099	1100-1200
VIDRIO VIDRO	Transparente	336 €	370 €	405 €	428 €
	Affumicato, Bronce, Mate, Transp. decorado	420 €	463 €	506 €	535 €
	Affumicato decorado Bronce decorado Nuevos / Novos decorados *	470 €	518 €	567 €	599 €

\* Para serigrafías digitales confirmar precio con ATC. / Para serigrafías digitais confirmar preço com ATC.

### VIDRIO Y DECORADO VIDRO E DECORADO

TRANSP.



SIN DECORADO



PICTOR

AFFUMICATO



SIN DECORADO



PICTOR

BRONCE



SIN DECORADO



PICTOR

MATE



SIN DECORADO

### NUEVOS DECORADOS NOVOS DECORADOS

SERIGRAFIAS ESPECIALES



MIRAI



WETLANDS



GRID

SERIGRAFIAS DIGITALES



BAMBOO



WAVE



FOG

PWC | WALK IN DE DUCHA: 1 PUERTA CORREDERA Y 1 FIJO  
WALK IN DE DUCHE: 1 PORTA DE CORRER E 1 FIXO

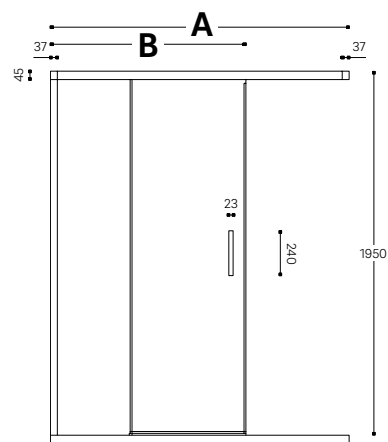

Dimensiones en mm.  
Dimensões em mm.



VIDRIO TEMPLADO  
VIDRO TEMPERADO  
**6 MM**



COMPENSAÇÃO  
COMPENSAÇÃO  
**15 MM**



ALTURA MODELO DUCHA  
ALTURA MODELO DUCHE  
**1950 MM**



TRATAMIENTO OPCIONAL (M)  
TRATAMENTO OPCIONAL (M)  
**65€**



MEDIDAS Y ALTURAS ESPECIALES  
MEDIDAS E ALTURAS ESPECIAIS  
(VER PÁG. / CONSULTA A PÁG. **372**)



PUERTAS DESMONTABLES,  
**FÁCIL LIMPIEZA**  
PORTAS REMOVÍVEIS,  
**FÁCIL LIMPEZA**



MONTAJE  
MONTAJEM  
**100 € \***

\* Precio recomendado  
Código montaje **CSM06**  
Para desplazamientos  
consultar pág. **373**

\* Preço recomendado  
Código montagem **CSM06**  
Para deslocações  
consultar pág. **373**

## ACABADOS METÁLICOS ACABAMENTOS METÁLICOS



BLANCO  
BRANCO



PLATA BRILLO  
PRATA BRILHO



PLATA MATE  
PRATA MATE

# PWC | DUCHA DUCHE

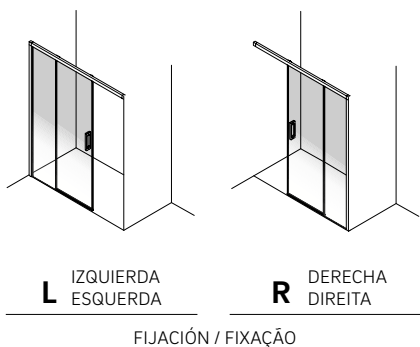

		<b>A mm</b>	
		1600	2000
HUECO DE LUZ FRONTAL mm ESPAÇO LIVRE FRONTAL mm		1200-1600	1601-2000
<b>B</b>	SUMA DE LOS CRISTALES mm SOMA DOS CRISTAIS mm	1000	1200
<b>PERFIL BLANCO - PLATA BRILLO - PLATA MATE</b> <b>PERFIL BRANCO - PRATA BRILHO - PRATA MATE</b>			
VIDRIO VIDRO	Transparente	630 €	676 €
	Affumicato, Bronce, Mate, Transp. decorado	788 €	845 €
	Affumicato decorado Bronce decorado Nuevos / Novos decorados *	882 €	946 €

\* Para serigrafías digitales confirmar precio con ATC. / Para serigrafias digitais confirmar preço com ATC.

## VIDRIO Y DECORADO VIDRO E DECORADO



## NUEVOS DECORADOS NOVOS DECORADOS



PWQ

WALK IN DE DUCHA: 1 PUERTA CORREDERA Y 1 FIJO CON GUIA A PARED CONTRARIA  
WALK IN DE DUCHE: 1 PORTA DE CORRER E 1 FIXO COM GUIA PARA PAREDE OPOSTA

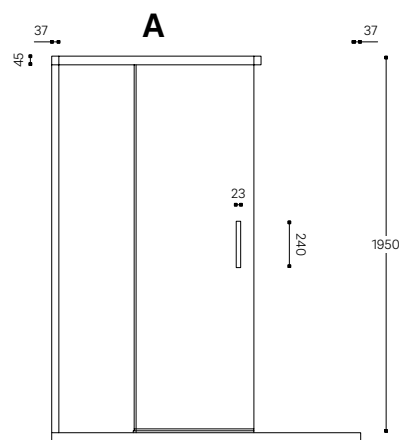

Dimensiones en mm.  
Dimensões em mm.



VIDRIO TEMPLADO  
VIDRO TEMPERADO  
**6 MM**



COMPENSACIÓN  
COMPENSAÇÃO  
**15 MM**



ALTURA MODELO DUCHA  
ALTURA MODELO DUCHE  
**1950 MM**



TRATAMIENTO OPCIONAL (M)  
TRATAMENTO OPCIONAL (M)  
**65€**



MEDIDAS Y ALTURAS ESPECIALES  
MEDIDAS E ALTURAS ESPECIAIS  
(VER PÁG. / CONSULTA A PÁG. **372**)



PUERTAS DESMONTABLES,  
**FÁCIL LIMPIEZA**  
PORTAS REMOVÍVEIS,  
**FÁCIL LIMPEZA**



Longitud máxima del tirante  
Extensão máxima do braço suporte  
**1000 MM**



MONTAJE  
MONTAJEM  
**100 € \***

\* Precio recomendado  
Código montaje **CSM06**  
Para desplazamientos  
consultar pág. **373**

\* Preço recomendado  
Código montagem **CSM06**  
Para deslocações  
consultar pág. **373**

## ACABADOS METÁLICOS ACABAMENTOS METÁLICOS



BLANCO  
BRANCO



PLATA BRILLO  
PRATA BRILHO



PLATA MATE  
PRATA MATE

# PWQ | DUCHA DUCHE

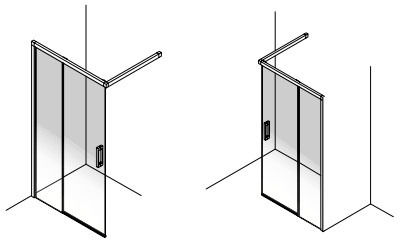

**L** IZQUIERDA  
ESQUERDA

**R** DERECHA  
DIREITA

FIJACIÓN / FIXAÇÃO

**A mm**

	1000	1200	
MEDIDA FRONTAL EN mm	1000	1200	
MEDIDA FRONTAL EN mm	1000	1200	
SUMA DE LOS CRISTALES mm	950	1150	
SOMA DOS CRISTAIS mm	950	1150	
<b>PERFIL BLANCO - PLATA BRILLO - PLATA MATE</b>			
<b>PERFIL BRANCO - PRATA BRILHO - PRATA MATE</b>			
VIDRIO VIDRO	Transparente	630 €	676 €
	Affumicato, Bronze, Mate, Transp. decorado	788 €	845 €
	Affumicato decorado Bronze decorado Nuevos / Novos decorados *	882 €	946 €

\* Para serigrafías digitales confirmar precio con ATC. / Para serigrafias digitais confirmar preço com ATC.

## VIDRIO Y DECORADO VIDRO E DECORADO

TRANSP.



SIN DECORADO



PICTOR

AFFUMICATO



SIN DECORADO



PICTOR

BRONCE



SIN DECORADO



PICTOR

MATE



SIN DECORADO

## NUEVOS DECORADOS NOVOS DECORADOS

SERIGRAFIAS ESPECIALES



MIRAI



WETLANDS



GRID

SERIGRAFIAS DIGITALES



BAMBOO



WAVE



FOG

# plus

PWS | WALK IN DE DUCHA: 1 PUERTA BATIENTE Y 1 FIJO  
WALK IN DE DUCHE: 1 PORTA DE ABRIR E 1 FIXO

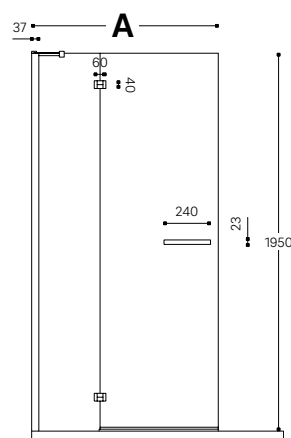

Dimensiones en mm.  
Dimensões em mm.



VIDRIO TEMPLADO  
VIDRO TEMPERADO  
6 MM



COMPENSACIÓN  
COMPENSAÇÃO  
15 MM



ALTURA MODELO DUCHA  
ALTURA MODELO DUCHE  
1950 MM



TRATAMIENTO OPCIONAL (M)  
TRATAMENTO OPCIONAL (M)  
65€



MEDIDAS Y ALTURAS ESPECIALES  
MEDIDAS E ALTURAS ESPECIAIS  
(VER PÁG. / CONSULTA A PÁG. 372)



UP&DOWN  
UP&DOWN



APERTURA  
ABERTURA  
90°



MONTAJE  
MONTAJEM  
100 € \*

\* Precio recomendado  
Código montaje **CSM06**  
Para desplazamientos  
consultar pág. 373

\* Preço recomendado  
Código montagem **CSM06**  
Para deslocações  
consultar pág. 373

## ACABADOS METÁLICOS ACABAMENTOS METÁLICOS



BLANCO  
BRANCO



PLATA BRILLO  
PRATA BRILHO



PLATA MATE  
PRATA MATE



# PWS | DUCHA DUCHE

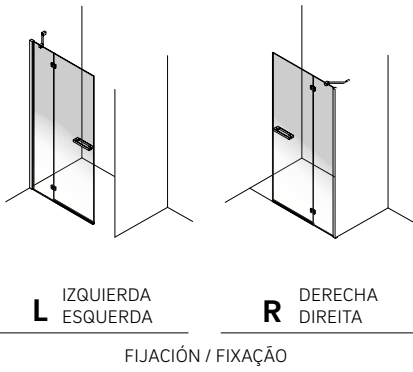

		<b>A mm</b>	
		800-900	901-1300
<b>MEDIDAS DE LA PUERTA mm</b> <b>TAMANHO DA PORTA mm</b>		500	600
<b>PERFIL BLANCO - PLATA BRILLO - PLATA MATE</b> <b>PERFIL BRANCO - PRATA BRILHO - PRATA MATE</b>			
<b>VIDRIO</b> <b>VIDRO</b>	Transparente	532 €	572 €
	Affumicato, Bronce, Mate, Transp. decorado	665 €	715 €
	Affumicato decorado Bronce decorado Nuevos / Novos decorados *	745 €	801 €

\* Para serigrafías digitales confirmar precio con ATC. / Para serigrafias digitais confirmar preço com ATC.

## VIDRIO Y DECORADO VIDRO E DECORADO



## NUEVOS DECORADOS NOVOS DECORADOS



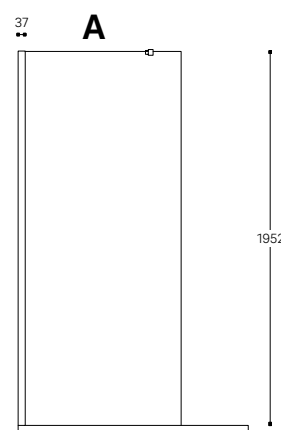

Dimensiones en mm.  
Dimensões em mm.



VIDRIO TEMPLADO  
VIDRO TEMPERADO  
**6 MM**



COMPENSACIÓN  
COMPENSAÇÃO  
**15 MM**



ALTURA MODELO DUCHA  
ALTURA MODELO DUCHE  
**1950 MM**



TRATAMIENTO OPCIONAL (M)  
TRATAMENTO OPCIONAL (M)  
**45€**



MEDIDAS Y ALTURAS ESPECIALES  
MEDIDAS E ALTURAS ESPECIAIS  
(VER PÁG. / CONSULTA A PÁG. **372**)



REVERSIBLE  
REVERSÍVEL



Longitud máxima del tirante  
Extensão máxima do braço suporte  
**1000 MM**



MONTAJE  
MONTAJEM  
**100 € \***

\* Precio recomendado  
Código montaje **CSM06**  
Para desplazamientos  
consultar pág. **373**

\* Preço recomendado  
Código montagem **CSM06**  
Para deslocações  
consultar pág. **373**

## ACABADOS METÁLICOS ACABAMENTOS METÁLICOS



BLANCO  
BRANCO



PLATA BRILLO  
PRATA BRILHO



PLATA MATE  
PRATA MATE



NEGRO MATE  
PRETO MATE

# TW1 | DUCHA DUCHE

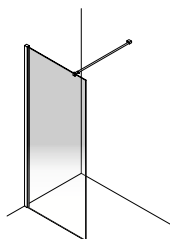

		<b>A mm</b>		
<b>PERFIL BLANCO - PLATA BRILLO - PLATA MATE</b>		<b>600-800</b>	<b>801-1000</b>	<b>1001-1200</b>
<b>PERFIL BRANCO - PRATA BRILHO - PRATA MATE</b>				
VIDRIO VIDRO	Transparente	295 €	336 €	376 €
	Affumicato, Bronce, Mate, Transp. decorado	369 €	420 €	470 €
	Affumicato decorado Bronce decorado Nuevos / Novos decorados *	413 €	470 €	526 €
<b>PERFIL NEGRO MATE</b>				
<b>PERFIL PRETO MATE</b>				
VIDRIO VIDRO	Transparente	366 €	415 €	464 €
	Affumicato, Bronce, Mate, Transp. decorado	458 €	519 €	580 €
	Affumicato decorado Bronce decorado Nuevos / Novos decorados *	512 €	581 €	650 €

\* Para serigrafías digitales confirmar precio con ATC. / Para serigrafías digitais confirmar preço com ATC.

## VIDRIO Y DECORADO VIDRO E DECORADO

TRANSP.



SIN DECORADO



PICTOR

AFFUMICATO



SIN DECORADO



PICTOR

BRONCE



SIN DECORADO



PICTOR

MATE



SIN DECORADO

## NUEVOS DECORADOS NOVOS DECORADOS

SERIGRAFÍAS ESPECIALES



MIRAI



WETLANDS



GRID

SERIGRAFÍAS DIGITALES



BAMBOO



WAVE



FOG

TWT | WALK IN DE DUCHA: 1 FIJO Y 1 HOJA BATIENTE  
WALK IN DE DUCHE: 1 FIXO E 1 FOLHA DE ABRIR

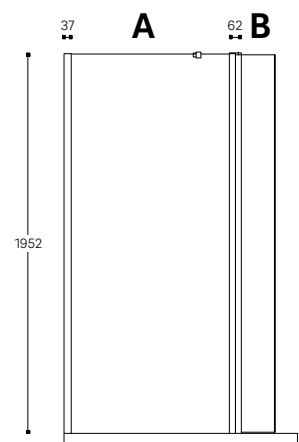

Dimensiones en mm.  
Dimensões em mm.



VIDRIO TEMPLADO  
VIDRO TEMPERADO  
**6 MM**



COMPENSACIÓN  
COMPENSAÇÃO  
**15 MM**



APERTURA  
ABERTURA  
**180°**



TRATAMIENTO OPCIONAL (M)  
TRATAMENTO OPCIONAL (M)  
**55€**



MEDIDAS Y ALTURAS ESPECIALES  
MEDIDAS E ALTURAS ESPECIAIS  
(VER PÁG. / CONSULTA A PÁG. **372**)



REVERSIBLE  
REVERSÍVEL



Longitud máxima del tirante  
Extensão máxima do braço suporte  
**1000 MM**



MONTAJE  
MONTAJEM  
**100 € \***

\* Precio recomendado  
Código montaje **CSM06**  
Para desplazamientos  
consultar pág. **373**

\* Preço recomendado  
Código montagem **CSM06**  
Para deslocações  
consultar pág. **373**

## ACABADOS METÁLICOS ACABAMENTOS METÁLICOS



BLANCO  
BRANCO



PLATA BRILLO  
PRATA BRILHO



PLATA MATE  
PRATA MATE

# TWT | BATIENTE

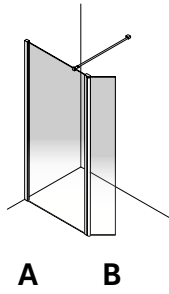

		A mm	
		600-799	800-1000
B mm	PUERTA ABATIBLE mm PORTA BATENTE mm	200	200
<b>PERFIL BLANCO - PLATA BRILLO - PLATA MATE</b> <b>PERFIL BRANCO - PRATA BRILHO - PRATA MATE</b>			
VIDRIO VIDRO	Transparente	544 €	572 €
	Affumicato, Bronce, Mate, Transp. decorado	680 €	715 €
	Affumicato decorado Bronce decorado Nuevos / Novos decorados *	762 €	801 €

\* Para serigrafías digitales confirmar precio con ATC. / Para serigrafías digitais confirmar preço com ATC.

## VIDRIO Y DECORADO VIDRO E DECORADO



## NUEVOS DECORADOS NOVOS DECORADOS



# technic

TWH | WALK IN 1 DE DUCHA: 1 FIJO Y 1 HOJA BATIENTE  
WALK IN 1 DE DUCHE: 1 FIXO E 1 PORTA DE ABRIR

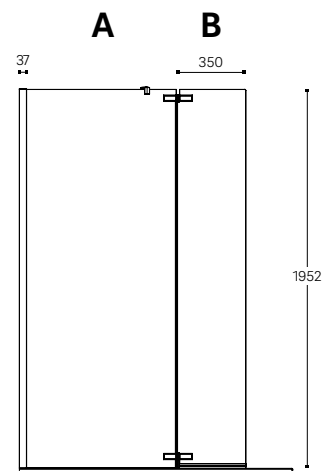

Dimensiones en mm.  
Dimensões em mm.



VIDRIO TEMPLADO  
VIDRO TEMPERADO  
6 MM



COMPENSAÇÃO  
COMPENSAÇÃO  
15 MM



ALTURA ESTÁNDAR  
ALTURA NORMA  
1950 MM



TRATAMIENTO OPCIONAL (M)  
TRATAMENTO OPCIONAL (M)  
65€



MEDIDAS Y ALTURAS ESPECIALES  
MEDIDAS E ALTURAS ESPECIAIS  
(VER PÁG. / CONSULTA A PÁG. 372)



REVERSIBLE  
REVERSÍVEL



APERTURA  
ABERTURA  
180°



MONTAJE  
MONTAJEM  
100 € \*

\* Precio recomendado  
Código montaje **CSM06**  
Para desplazamientos  
consultar pág. 373

\* Preço recomendado  
Código montagem **CSM06**  
Para deslocações  
consultar pág. 373

## ACABADOS METÁLICOS ACABAMENTOS METÁLICOS



PLATA BRILLO  
PRATA BRILHO



NEGRO MATE  
PRETO MATE

# TWH | DUCHA DUCHE

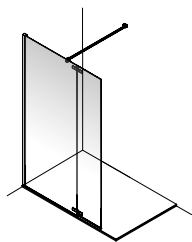

		<b>A mm</b>	
		800-1000	1001-1200
<b>B mm</b>	PUERTA ABATIBLE PORTA BATENTE	350	350
<b>PERFIL PLATA BRILLO PERFIL PRATA BRILHO</b>			
VIDRIO VIDRO	Transparente	616 €	770 €
	Affumicato, Bronce, Mate, Transp. decorado	770 €	963 €
	Affumicato decorado Bronce decorado Nuevos / Novos decorados *	862 €	1.078 €
<b>PERFIL NEGRO MATE PERFIL PRETO MATE</b>			
VIDRIO VIDRO	Transparente	740 €	786 €
	Affumicato, Bronce, Mate, Transp. decorado	925 €	983 €
	Affumicato decorado Bronce decorado Nuevos / Novos decorados *	1.036 €	1.100 €

\* Para serigrafías digitales confirmar precio con ATC. / Para serigrafías digitais confirmar preço com ATC.

## VIDRIO Y DECORADO VIDRO E DECORADO

TRANSP.



SIN DECORADO



PICTOR

AFFUMICATO



SIN DECORADO



PICTOR

BRONCE



SIN DECORADO



PICTOR

MATE



SIN DECORADO

## NUEVOS DECORADOS NOVOS DECORADOS

SERIGRAFIAS ESPECIALES



MIRAI



WETLANDS



GRID

SERIGRAFIAS DIGITALES



BAMBOO



WAVE



FOG

# technic

TWB | WALK IN DE DUCHA: 1 PUERTA BATIENTE  
WALK IN DE DUCHE: 1 PORTA DE ABRIR

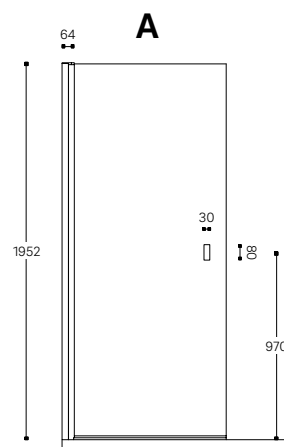

Dimensiones en mm.  
Dimensões em mm.



VIDRIO TEMPLADO  
VIDRO TEMPERADO  
6 MM



COMPENSAÇÃO  
COMPENSAÇÃO  
15 MM



ALTURA MODELO DUCHA  
ALTURA MODELO DUCHE  
1950 MM



TRATAMIENTO OPCIONAL (M)  
TRATAMENTO OPCIONAL (M)  
45€



MEDIDAS Y ALTURAS ESPECIALES  
MEDIDAS E ALTURAS ESPECIAIS  
(VER PÁG. / CONSULTA A PÁG. 372)



REVERSIBLE  
REVERSÍVEL



APERTURA  
ABERTURA  
180°



UP&DOWN  
UP&DOWN



MONTAJE  
MONTAJEM  
100 € \*

\* Preço recomendado  
Código montagem **CSM06**  
Para deslocamentos  
consultar pág. 373

\* Preço recomendado  
Código montagem **CSM06**  
Para deslocações  
consultar pág. 373

## ACABADOS METÁLICOS ACABAMENTOS METÁLICOS



BLANCO  
BRANCO



PLATA BRILLO  
PRATA BRILHO



PLATA MATE  
PRATA MATE



# TWB | DUCHA DUCHE

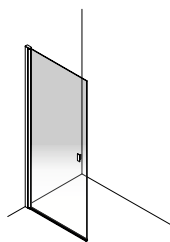

		<b>A mm</b>	
		600-800	801-1000
<b>PERFIL BLANCO - PLATA BRILLO - PLATA MATE</b>			
<b>PERFIL BRANCO - PRATA BRILHO - PRATA MATE</b>			
VIDRIO VIDRO	Transparente	439 €	480 €
	Affumicato, Bronce, Mate, Transp. decorado	549 €	600 €
	Affumicato decorado Bronce decorado Nuevos / Novos decorados *	615 €	672 €

\* Para serigrafías digitales confirmar precio con ATC. / Para serigrafías digitais confirmar preço com ATC.

## VIDRIO Y DECORADO VIDRO E DECORADO

TRANSP.



SIN DECORADO



PICTOR

AFFUMICATO



SIN DECORADO



PICTOR

BRONCE



SIN DECORADO



PICTOR

MATE



SIN DECORADO

## NUEVOS DECORADOS NOVOS DECORADOS

SERIGRAFIAS ESPECIALES



MIRAI



WETLANDS



GRID

SERIGRAFIAS DIGITALES



BAMBOO



WAVE



FOG

# technic

TWS | WALK IN 1 DE DUCHA: 1 PUERTA BATIENTE Y 1 FIJO  
WALK IN 1 DE DUCHE: 1 PORTA DE ABRIR E 1 FIXO

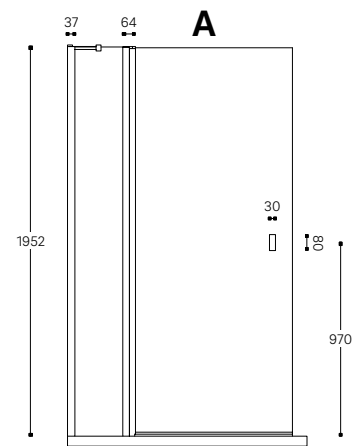

Dimensiones en mm.  
Dimensões em mm.



VIDRIO TEMPLADO  
VIDRO TEMPERADO  
6 MM



COMPENSAÇÃO  
COMPENSAÇÃO  
15 MM



ALTURA MODELO DUCHA  
ALTURA MODELO DUCHE  
1950 MM



TRATAMIENTO OPCIONAL (M)  
TRATAMENTO OPCIONAL (M)  
65€



MEDIDAS Y ALTURAS ESPECIALES  
MEDIDAS E ALTURAS ESPECIAIS  
(VER PÁG. / CONSULTA A PÁG. 372)



REVERSIBLE  
REVERSÍVEL



APERTURA  
ABERTURA  
180°



UP&DOWN  
UP&DOWN



MONTAJE  
MONTAJEM  
100 € \*

\* Precio recomendado  
Código montaje **CSM06**  
Para desplazamientos  
consultar pág. 373

\* Preço recomendado  
Código montagem **CSM06**  
Para deslocações  
consultar pág. 373

## ACABADOS METÁLICOS ACABAMENTOS METÁLICOS



BLANCO  
BRANCO



PLATA BRILLO  
PRATA BRILHO



PLATA MATE  
PRATA MATE

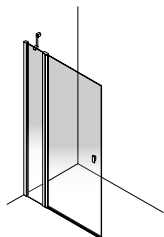

		<b>A mm</b>		
<b>PERFIL BLANCO - PLATA BRILLO - PLATA MATE</b> <b>PERFIL BRANCO - PRATA BRILHO - PRATA MATE</b>		<b>800-880</b>	<b>881-1200</b>	<b>1201-1400</b>
<b>VIDRIO</b> <b>VIDRO</b>	Transparente	532 €	572 €	613 €
	Affumicato, Bronce, Mate, Transp. decorado	665 €	715 €	766 €
	Affumicato decorado Bronce decorado Nuevos / Novos decorados *	745 €	801 €	858 €
<b>MEDIDA PUERTA / MEDIDA PORTA mm</b>		500	600	700

\* Para serigrafías digitales confirmar precio con ATC. / Para serigrafias digitais confirmar preço com ATC.

**VIDRIO Y DECORADO**  
**VIDRO E DECORADO**



**NUEVOS DECORADOS**  
**NOVOS DECORADOS**





# Correderas

Portas de correr





Stock

Info







Puertas desmontables con tan sólo un click,  
facilitando la limpieza.

Portas desmontáveis com apenas um clique,  
facilitando a limpeza.









Cierre de seguridad Soft-Close, con amortiguador, incluido. Frena la inercia de movimiento de la puerta mediante un mecanismo hidráulico consiguiendo un cierre suave y progresivo.

Fecho de segurança Soft-Close, com amortecedor. Trava a inércia de movimento da porta mediante um mecanismo hidráulico conseguindo um fecho suave e progressivo.





Acabado de la guía en negro mate  
que subraya y enfatiza las líneas de diseño  
de la mampara.

---

Acabamento da guia de negro mate  
que realça e enfatiza as linhas  
do design da divisória.











Acabados del aluminio anodizado en plata brillo y negro mate gravado. Este tratamiento hace posible un acabado en negro homogéneo, consiguiendo asimismo que las huellas no queden marcadas.

---

Acabamentos do alumínio anodizado em prata brilhante e preto mate gravado. Este tratamento torna possível um acabamento em preto homogéneo, garantindo dessa forma que as dedadas não fiquem marcadas.





Mirai también es seguridad. Los sistemas de rodamientos y regulación se deslizan suavemente por el interior de la mampara. En el exterior, el perfil queda completamente limpio a la vista, sin elementos técnicos visibles.

Tecnología y estética se suman en esta colección. Los mecanismos destacan por su elevada calidad, ya que han sido testeados por nuestros especialistas en mamparas. El sistema de freno y tope de seguridad SAFE-CLOSE mantiene la posición de apertura y de cierre asegurando que la puerta quede bien encajada sin posibilidad de escape de agua. Otro punto favorable es el sistema liberador de puertas que, con solo pulsar en un punto, permite bascular la puerta para facilitar la limpieza con total seguridad.

Mirai também é segurança. Os sistemas de rolamentos e regulação deslizam suavemente pelo interior da divisória. No exterior, o perfil fica completamente limpo à vista, sem elementos técnicos visíveis.

Tecnologia e estética aliam-se a esta coleção. Os mecanismos destacam-se pela sua elevada qualidade, uma vez que foram testados pelos nossos especialistas em divisórias. O sistema de travagem e fecho de segurança SAFE-CLOSE mantém a posição de abertura e fecho da porta bem encaixada sem possibilidade de saída de água. Outro ponto a favor é o sistema de desprender as portas que, apenas com o pressionar em um ponto, permite levantar a porta para facilitar a limpeza com segurança total.











Guías de líneas modernas que encajan en ambientes actuales, disponibles en diferentes acabados como el blanco, también en plata brillo y plata mate. Tirador con forma de asidero específico para los modelos de la colección Plus.

Guías de linhas modernas que encaixam em ambientes atuais, disponíveis em diferentes acabamentos como o branco, também em prata brilhante e prata mate. Puxador com forma de pega específico para os modelos da coleção Plus.









Nuevos rodamientos simplificados  
para un mejor funcionamiento.

Novos rolamentos simplificados para  
um melhor funcionamento.







Stock

Info

TECHNIC TC2

117







Puertas desmontables con tan sólo un click,  
facilitando la limpieza.

Portas desmontáveis com apenas um clique,  
facilitando a limpeza.









Decorados con serigrafías sobre vidrio con 8 acabados disponibles desde el más clásico hasta el más atrevido

Decorações com serigrafias sobre vidro com 8 acabamentos disponíveis, desde o mais clássico ao mais atrevido.

# mirai

**MC2**  
VIDRIO 6 MM  
VIDRO

**8C2**  
VIDRIO 8 MM  
VIDRO

MAMPARA DE DUCHA: 1 PUERTA CORREDERA Y 1 FIJO ENTRE PAREDES  
DIVISÓRIA DE DUCHE: 1 PORTA DE CORRER E 1 FIXO ENTRE PAREDE

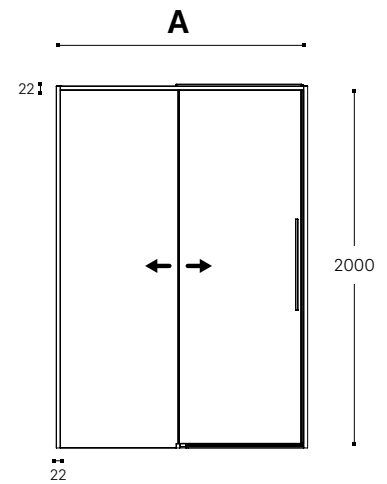

Dimensiones en mm.  
Dimensões em mm.



VIDRIO TEMPLADO  
6 o 8 MM  
VIDRO TEMPERADO  
6 u 8 MM



SAFE-CLOSE  
SAFE-CLOSE



COMPENSACIÓN A CADA LADO  
COMPENSAÇÃO A CADA LADO  
12 MM



TRATAMIENTO OPCIONAL  
TRATAMENTO OPCIONAL  
65 €



ALTURA ESTÁNDAR  
2000 MM  
ALTURA ESPECIAL  
HASTA / ATÉ 2100 MM



MEDIDAS Y ALTURAS ESPECIALES  
CONSULTAR CUSTOMER SERVICE  
MEDIDAS E ALTURAS ESPECIAIS  
CONSULTE CUSTOMER SERVICE



MONTAJE  
MONTAJEM  
95 € \*

\* Precio recomendado  
Código montaje **CSM05**  
Para desplazamientos  
consultar pág. **373**

\* Preço recomendado  
Código montagem **CSM05**  
Para deslocações  
consultar pág. **373**

## ACABADOS METÁLICOS ACABAMENTOS METÁLICOS



BRILLO  
BRILHO



NEGRO MATE  
PRETO MATE

## 2 TIPOS DE TIRADOR DISPONIBLES 2 TIPOS DE PUXADOR DISPONÍVEIS



TIRADOR  
TRADICIONAL  
PUXADOR  
TRADICIONAL  
500 MM



UÑERO PARA MÁXIMA  
APERTURA  
PUXADOR INTEGRADO PARA  
ABERTURA MÁXIMA  
Ø55 MM

# MC2 | 8C2 | FRONTAL

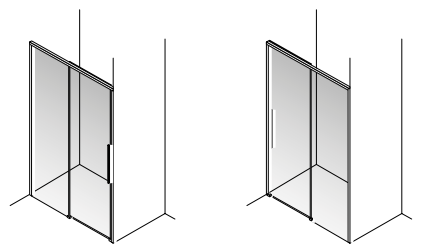

**L** IZQUIERDA  
ESQUERDA

**R** DERECHA  
DIREITA

APERTURA / ABERTURA

Para conseguir la máxima apertura se recomienda opción de uñero en las puertas.

Para conseguir a abertura máxima, recomenda-se opção de puxador integrado nas portas.

**A mm**

PERFIL BRILLO - NEGRO MATE PERFIL BRILHO - PRETO MATE		1000-1300	1301-1600	1601-1800	1801-2000
VIDRIO 6MM VIDRO 6MM	Transparente	699 €	752 €	793 €	829 €
	Affumicato, Bronce, Mate, Transp. decorado	874 €	940 €	991 €	1.036 €
	Affumicato decorado Bronce decorado Nuevos / Novos decorados *	979 €	1.053 €	1.110 €	1.161 €

PERFIL BRILLO - NEGRO MATE PERFIL BRILHO - PRETO MATE		1000-1300	1301-1600	1601-1800	1801-2000
VIDRIO 8MM VIDRO 8MM	Transparente	803 €	865 €	912 €	953 €
	Affumicato, Bronce, Mate, Transp. decorado	1.004 €	1.081 €	1.140 €	1.191 €
	Affumicato decorado Bronce decorado Nuevos / Novos decorados *	1.124 €	1.211 €	1.277 €	1.334 €
ENTRADA MÍNIMA CON TIRADOR mm		442	592	742	842
ENTRADA MÍNIMO COM PUXADOR mm					
ENTRADA MÍNIMA CON UÑERO mm		465	615	765	865
ENTRADA MÍNIMO COM PUXADOR INTEGRADO mm					

\* Para serigrafías digitales confirmar precio con ATC. / Para serigrafías digitais confirmar preço com ATC.

## VIDRIO Y DECORADO VIDRO E DECORADO

TRANSP.	AFFUMICATO	BRONCE	MATE
SIN DECORADO	SIN DECORADO	SIN DECORADO	SIN DECORADO
PICTOR	PICTOR	PICTOR	

## NUEVOS DECORADOS NOVOS DECORADOS

SERIGRAFÍAS ESPECIALES		SERIGRAFÍAS DIGITALES	
MIRAI	WETLANDS	BAMBOO	WAVE
GRID		FOG	

# mirai

**MC7**  
VIDRIO 6 MM  
VIDRO

**8C7**  
VIDRIO 8 MM  
VIDRO

MAMPARA DE DUCHA: 1 PUERTA CORREDERA Y 1 FIJO MÁS LATERAL A PUERTA  
DIVISÓRIA DE DUCHE: 1 PORTA DE CORRER E 1 FIXO MAIS LATERAL A LA PORTA

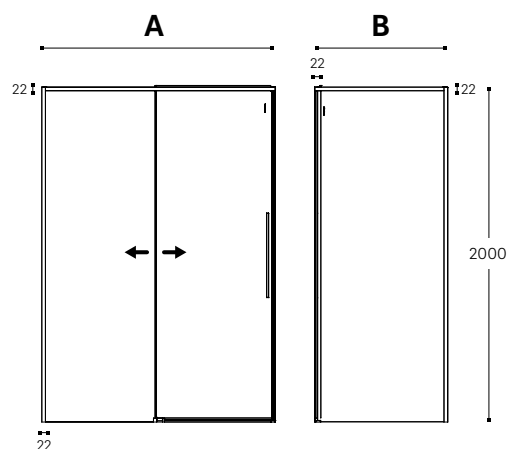

Dimensiones en mm.  
Dimensões em mm.



VIDRIO TEMPLADO  
6 o 8 MM  
VIDRO TEMPERADO  
6 u 8 MM



SAFE-CLOSE  
SAFE-CLOSE



COMPENSACIÓN A CADA LADO  
COMPENSAÇÃO A CADA LADO  
12 MM



TRATAMIENTO OPCIONAL (M)  
TRATAMENTO OPCIONAL (M)  
65 € FRONTAL + 35 € LATERAL



ALTURA ESTÁNDAR  
2000 MM  
ALTURA ESPECIAL  
HASTA / ATÉ 2100 MM



MEDIDAS Y ALTURAS ESPECIALES  
CONSULTAR CUSTOMER SERVICE  
MEDIDAS E ALTURAS ESPECIAIS  
CONSULTE CUSTOMER SERVICE



MONTAJE  
MONTAJEM  
120 € \*

\* Precio recomendado  
Código montaje **CSM10**  
Para desplazamientos  
consultar pág. **373**

\* Preço recomendado  
Código montagem **CSM10**  
Para deslocações  
consultar pág. **373**

## ACABADOS METÁLICOS ACABAMENTOS METÁLICOS



BRILLO  
BRILHO



NEGRO MATE  
PRETO MATE

## 2 TIPOS DE TIRADOR DISPONIBLES 2 TIPOS DE PUXADOR DISPONÍVEIS



TIRADOR  
TRADICIONAL  
PUXADOR  
TRADICIONAL  
500 MM



UÑERO PARA MÁXIMA  
APERTURA  
PUXADOR INTEGRADO PARA  
ABERTURA MÁXIMA  
Ø55 MM



## MC7 | 8C7 | FRONTAL

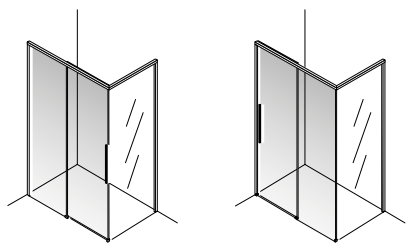

**L** IZQUIERDA  
ESQUERDA

**R** DERECHA  
DIREITA

APERTURA / ABERTURA

Para conseguir la máxima apertura se recomienda opción de uñero en las puertas.

Para conseguir a abertura máxima, recomenda-se opção de puxador integrado nas portas.

**A mm**

PERFIL BRILLO - NEGRO MATE PERFIL BRILHO - PRETO MATE	1000-1300	1301-1600	1601-1800	1801-2000
Transparente	699 €	752 €	793 €	829 €
VIDRIO 6MM VIDRO 6MM				
Affumicato, Bronce, Mate, Transp. decorado	874 €	940 €	991 €	1.036 €
Affumicato decorado Bronce decorado Nuevos / Novos decorados *	979 €	1.053 €	1.110 €	1.161 €

**PERFIL BRILLO - NEGRO MATE  
PERFIL BRILHO - PRETO MATE**

	803 €	865 €	912 €	953 €
Transparente				
VIDRIO 8MM VIDRO 8MM				
Affumicato, Bronce, Mate, Transp. decorado	1.004 €	1.081 €	1.140 €	1.191 €
Affumicato decorado Bronce decorado Nuevos / Novos decorados *	1.124 €	1.211 €	1.277 €	1.334 €
ENTRADA MÍNIMA CON TIRADOR mm	442	592	742	842
ENTRADA MÍNIMO COM UÑERO mm				
ENTRADA MÍNIMA CON UÑERO mm	473	623	773	873
ENTRADA MÍNIMO COM PUXADOR INTEGRADO mm				

## MLC | 8LC | LATERAL

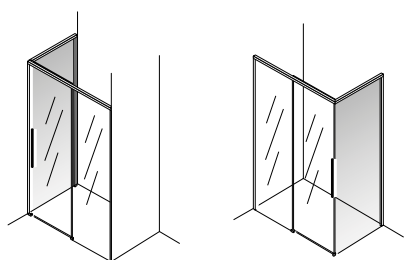

**L** IZQUIERDA  
ESQUERDA

**R** DERECHA  
DIREITA

FIJACIÓN / FIXAÇÃO

**B mm**

PERFIL BRILLO - NEGRO MATE PERFIL BRILHO - PRETO MATE	200-500	501-800	801-1000
Transparente	237 €	275 €	314 €
VIDRIO 6MM VIDRO 6MM			
Affumicato, Bronce, Mate, Transp. decorado	296 €	344 €	393 €
Affumicato decorado Bronce decorado Nuevos / Novos decorados *	332 €	385 €	440 €

**PERFIL BRILLO - NEGRO MATE  
PERFIL BRILHO - PRETO MATE**

	268 €	317 €	363 €
Transparente			
VIDRIO 8MM VIDRO 8MM			
Affumicato, Bronce, Mate, Transp. decorado	335 €	396 €	454 €
Affumicato decorado Bronce decorado Nuevos / Novos decorados *	375 €	444 €	508 €

\* Para serigrafías digitales confirmar precio con ATC. / Para serigrafías digitais confirmar preço com ATC.

### VIDRIO Y DECORADO VIDRO E DECORADO

TRANSP.	AFFUMICATO	BRONCE	MATE
SIN DECORADO	SIN DECORADO	SIN DECORADO	SIN DECORADO
PICTOR	PICTOR	PICTOR	

### NUEVOS DECORADOS NOVOS DECORADOS

SERIGRAFÍAS ESPECIALES	SERIGRAFÍAS DIGITALES
MIRAI	BAMBOO
WETLANDS	WAVE
GRID	FOG

# mirai

**MC3**  
VIDRIO 6 MM  
VIDRO

**8C3**  
VIDRIO 8 MM  
VIDRO

MAMPARA DE DUCHA: 1 PUERTA CORREDERA Y 1 FIJO MÁS LATERAL A PUERTA  
DIVISÓRIA DE DUCHE: 1 PORTA DE CORRER E 1 FIXO MAIS LATERAL A LA PORTA

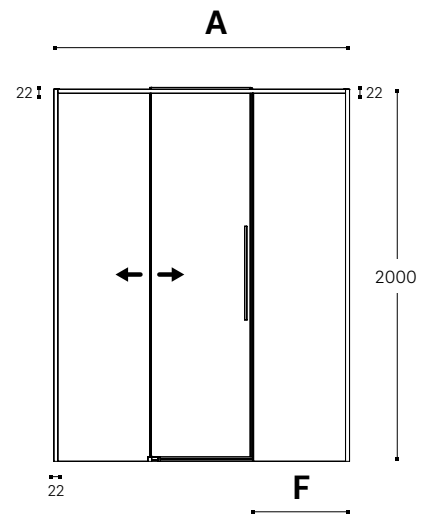

Dimensiones en mm.  
Dimensões em mm.



VIDRIO TEMPLADO  
6 o 8 MM  
VIDRO TEMPERADO  
6 u 8 MM



SAFE-CLOSE  
SAFE-CLOSE



COMPENSACIÓN A CADA LADO  
COMPENSAÇÃO A CADA LADO  
12 MM



TRATAMIENTO OPCIONAL (M)  
TRATAMENTO OPCIONAL (M)  
85 €



ALTURA ESTÁNDAR  
2000 MM  
ALTURA ESPECIAL  
HASTA / ATÉ 2100 MM



MEDIDAS Y ALTURAS ESPECIALES  
CONSULTAR CUSTOMER SERVICE  
MEDIDAS E ALTURAS ESPECIAIS  
CONSULTE CUSTOMER SERVICE



MONTAJE  
MONTAJEM  
100 € \*

\* Precio recomendado  
Código montaje **CSM06**  
Para desplazamientos  
consultar pág. **373**

\* Preço recomendado  
Código montagem **CSM06**  
Para deslocações  
consultar pág. **373**

## ACABADOS METÁLICOS ACABAMENTOS METÁLICOS



BRILLO  
BRILHO



NEGRO MATE  
PRETO MATE

## 2 TIPOS DE TIRADOR DISPONIBLES 2 TIPOS DE PUXADOR DISPONÍVEIS



TIRADOR  
TRADICIONAL  
PUXADOR  
TRADICIONAL  
500 MM



UÑERO PARA MÁXIMA  
APERTURA  
PUXADOR INTEGRADO PARA  
ABERTURA MÁXIMA  
Ø55 MM

# MC3 | 8C3 | FRONTAL

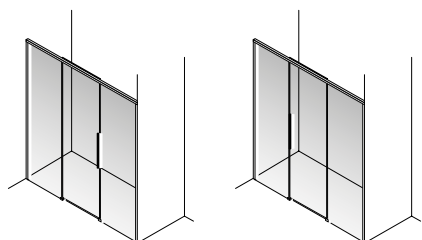

**L** IZQUIERDA  
ESQUERDA

**R** DERECHA  
DIREITA

APERTURA / ABERTURA

Puede indicarnos la medida del fijo F, para hacer la mampara ajustada a sus necesidades (como especial / sin aumento de coste). En caso de no indicar nada, la mampara se fabricará con los 2 fijos y la puerta del mismo tamaño (como imagen)

Pode indicar-nos o tamanho do fixo F, para fazer a mampara ajustada às suas necessidades (como especial / sem aumento de custo). Caso não indique nada, a divisoria será fabricada com as 2 fixos e a porta do mesmo tamanho (conforme imagem)

Para conseguir la máxima apertura se recomienda opción de uñero en las puertas.

Para conseguir a abertura máxima, recomenda-se opção de puxador integrado nas portas.

		<b>A mm</b>		
		<b>1300-1600</b>	<b>1601-1800</b>	<b>1801-2000</b>
<b>PERFIL BRILLO - NEGRO MATE</b> <b>PERFIL BRILHO - PRETO MATE</b>				
	Transparente	819 €	865 €	912 €
<b>VIDRIO 6MM</b> <b>VIDRO 6MM</b>	Affumicato, Bronce, Mate, Transp. decorado	1.024 €	1.081 €	1.140 €
	Affumicato decorado Bronce decorado Nuevos / Novos decorados *	1.147 €	1.211 €	1.277 €
<b>PERFIL BRILLO - NEGRO MATE</b> <b>PERFIL BRILHO - PRETO MATE</b>				
	Transparente	942 €	995 €	1.049 €
<b>VIDRIO 8MM</b> <b>VIDRO 8MM</b>	Affumicato, Bronce, Mate, Transp. decorado	1.178 €	1.244 €	1.343 €
	Affumicato decorado Bronce decorado Nuevos / Novos decorados *	1.319 €	1.393 €	1.469 €
	ENTRADA MÍNIMA CON TIRADOR mm	289	439	539
	ENTRADA MÍNIMO COM PUXADOR mm			
	ENTRADA MÍNIMA CON UÑERO mm	319	469	569
	ENTRADA MÍNIMO COM PUXADOR INTEGRADO mm			

\* Para serigrafías digitales confirmar precio con ATC. / Para serigrafias digitais confirmar preço com ATC.

## VIDRIO Y DECORADO VIDRO E DECORADO

TRANSP.



SIN DECORADO



PICTOR

AFFUMICATO



SIN DECORADO



PICTOR

BRONCE



SIN DECORADO



PICTOR

MATE



SIN DECORADO

## NUEVOS DECORADOS NOVOS DECORADOS

SERIGRAFIAS ESPECIALES



MIRAI



WETLANDS



GRID

SERIGRAFIAS DIGITALES



BAMBOO



WAVE



FOG

# mirai

**MC4**

VIDRIO 6 MM  
VIDRO

**8C4**

VIDRIO 8 MM  
VIDRO

MAMPARA DE DUCHA: 2 PUERTAS CORREDERAS Y 2 FIJOS ENTRE PAREDES  
DIVISÓRIA DE DUCHE 2 PORTA DE CORRER E 2 FIXOS ENTRE PAREDE

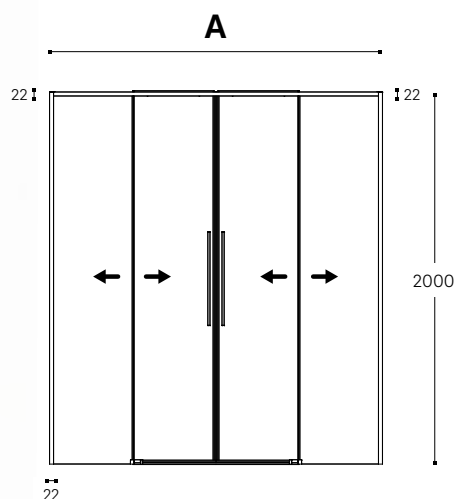
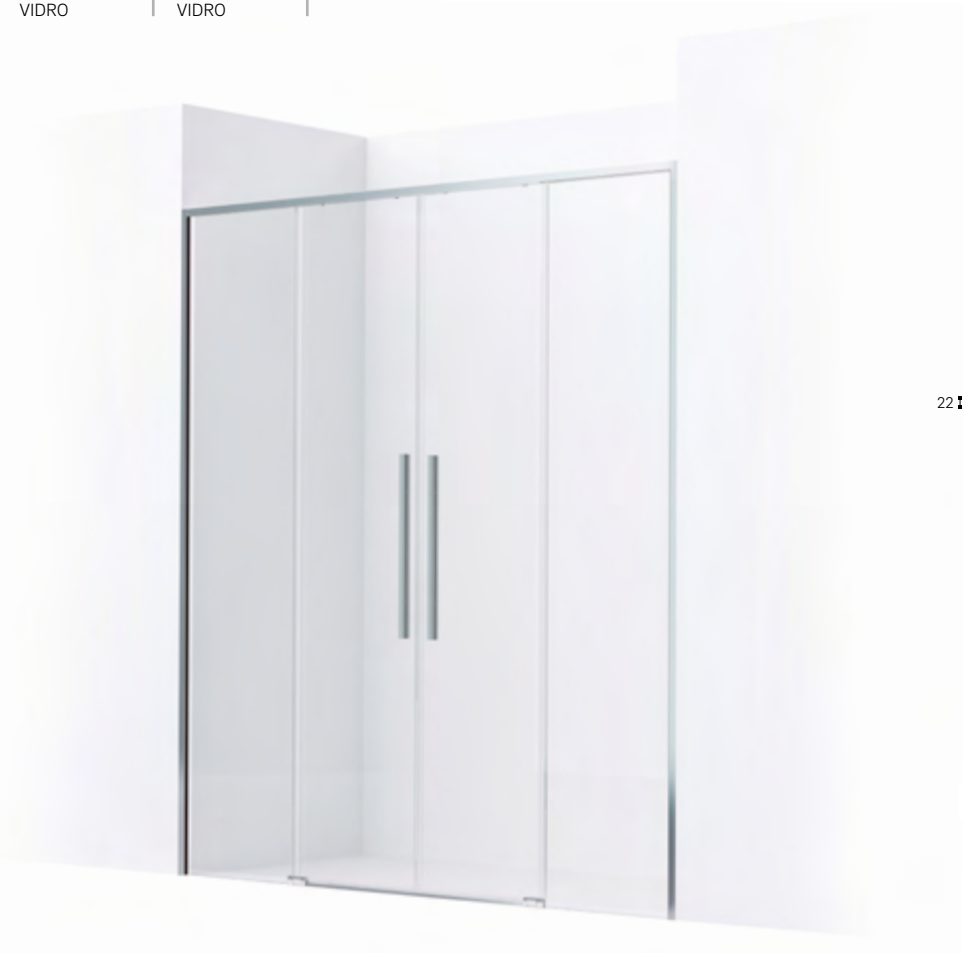

Dimensiones en mm.  
Dimensões em mm.



VIDRIO TEMPLADO  
6 o 8 MM  
VIDRO TEMPERADO  
6 u 8 MM



SAFE-CLOSE  
SAFE-CLOSE



COMPENSACIÓN A CADA LADO  
COMPENSAÇÃO A CADA LADO  
12 MM



TRATAMIENTO OPCIONAL (M)  
TRATAMENTO OPCIONAL (M)  
95 €



ALTURA ESTÁNDAR  
2000 MM  
ALTURA ESPECIAL  
HASTA / ATÉ 2100 MM



MEDIDAS Y ALTURAS ESPECIALES  
CONSULTAR CUSTOMER SERVICE  
MEDIDAS E ALTURAS ESPECIAIS  
CONSULTE CUSTOMER SERVICE



MONTAJE  
MONTAJEM  
105 € \*

\* Preço recomendado  
Código montaje **CSM07**  
Para desplazamientos  
consultar pág. 373

\* Preço recomendado  
Código montagem **CSM07**  
Para deslocações  
consultar pág. 373

## ACABADOS METÁLICOS ACABAMENTOS METÁLICOS



BRILLO  
BRILHO



NEGRO MATE  
PRETO MATE

## 2 TIPOS DE TIRADOR DISPONIBLES 2 TIPOS DE PUXADOR DISPONÍVEIS



TIRADOR  
TRADICIONAL  
PUXADOR  
TRADICIONAL  
500 MM



UÑERO PARA MÁXIMA  
APERTURA  
PUXADOR INTEGRADO PARA  
ABERTURA MÁXIMA  
Ø55 MM

# MC4 | 8C4 | FRONTAL

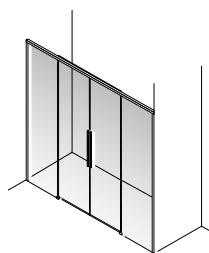

Para conseguir la máxima apertura se recomienda opción de uñero en las puertas.

Para conseguir a abertura máxima, recomenda-se opção de puxador integrado nas portas.

Para medidas a partir de 1600mm de ancho, el tamaño de las puertas, y la entrada útil no crece, solo aumenta el ancho de los fijos.

Para medidas a partir de 1600mm de largura, o tamanho das portas e da entrada útil não aumenta, apenas a largura das fixas aumenta.

		<b>A mm</b>		
		<b>1400-1600</b>	<b>1601-1800</b>	<b>1801-2000</b>
<b>PERFIL BRILLO - NEGRO MATE</b> <b>PERFIL BRILHO - PRETO MATE</b>				
	Transparente	949 €	996 €	1.044 €
<b>VIDRIO 6MM</b> <b>VIDRO 6MM</b>	Affumicato, Bronce, Mate, Transp. decorado	1.186 €	1.245 €	1.305 €
	Affumicato decorado Bronce decorado Nuevos / Novos decorados *	1.329 €	1.394 €	1.462 €
<b>PERFIL BRILLO - NEGRO MATE</b> <b>PERFIL BRILHO - PRETO MATE</b>				
	Transparente	1.055 €	1.145 €	1.198 €
<b>VIDRIO 8MM</b> <b>VIDRO 8MM</b>	Affumicato, Bronce, Mate, Transp. decorado	1.319 €	1.431 €	1.498 €
	Affumicato decorado Bronce decorado Nuevos / Novos decorados *	1.477 €	1.603 €	1.677 €
	ENTRADA MÍNIMA CON TIRADOR mm	596	696	696
	ENTRADA MÍNIMO COM PUXADOR mm			
	ENTRADA MÍNIMA CON UÑERO mm	665	765	765
	ENTRADA MÍNIMO COM PUXADOR INTEGRADO mm			

\* Para serigrafías digitales confirmar precio con ATC. / Para serigrafias digitais confirmar preço com ATC.

## VIDRIO Y DECORADO VIDRO E DECORADO



## NUEVOS DECORADOS NOVOS DECORADOS



# mirai

**MC5**  
VIDRIO 6 MM  
VIDRO

MAMPARA DE DUCHA: 2 PUERTAS CORREDERAS Y 2 FIJOS ENTRE PAREDES  
DIVISÓRIA DE DUCHE: 2 PORTA DE CORRER E 2 FIXOS ENTRE PAREDE

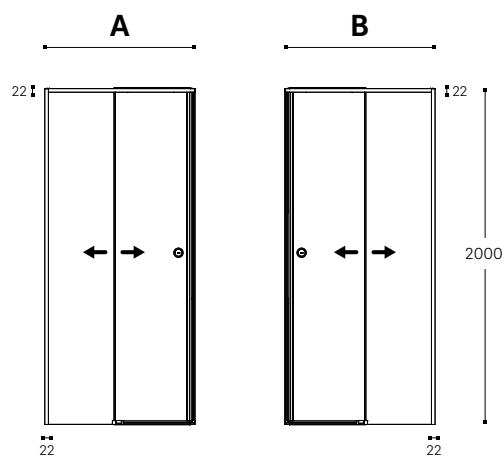

Dimensiones en mm.  
Dimensões em mm.



VIDRIO TEMPLADO  
6 o 8 MM  
VIDRO TEMPERADO  
6 u 8 MM



SAFE-CLOSE  
SAFE-CLOSE



COMPENSACIÓN A CADA LADO  
COMPENSAÇÃO A CADA LADO  
12 MM



TRATAMIENTO OPCIONAL (M)  
TRATAMENTO OPCIONAL (M)  
47,50 €



ALTURA ESTÁNDAR  
2000 MM  
ALTURA ESPECIAL  
HASTA / ATÉ 2100 MM



MEDIDAS Y ALTURAS ESPECIALES  
CONSULTAR CUSTOMER SERVICE  
MEDIDAS E ALTURAS ESPECIAIS  
CONSULTE CUSTOMER SERVICE



MONTAJE  
MONTAJEM  
125 € \*

\* Precio recomendado  
Código montaje **CSM11**  
Para desplazamientos  
consultar pág. 373

\* Preço recomendado  
Código montagem **CSM11**  
Para deslocações  
consultar pág. 373

## ACABADOS METÁLICOS ACABAMENTOS METÁLICOS



BRILLO  
BRILHO



NEGRO MATE  
PRETO MATE

## MODELO DISPONIBLE CON EL TIRADOR INTEGRADO MODELO DISPONÍVEL COM PUXADOR INTEGRADO



UÑERO PARA MÁXIMA  
APERTURA  
PUXADOR INTEGRADO PARA  
ABERTURA MÁXIMA  
Ø55 MM

# MC5

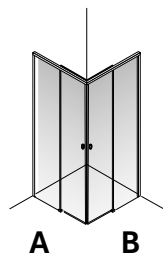

Para medidas a partir de 800x800mm de ancho, el tamaño de las puertas y la entrada útil no crece, solo aumenta el ancho de los fijos.

Para medidas a partir de 800x800mm de largura, o tamanho das portas e da entrada útil não aumenta, apenas a largura dos fixos aumenta.

Para precio total, sumar ambos lados A y B.  
Para o preço total, some os dois lados A e B.

		A mm			
		700-800	801-900	901-1000	1001-1200
<b>PERFIL BRILLO - NEGRO MATE</b> <b>PERFIL BRILHO - PRETO MATE</b>					
	Transparente	488 €	537 €	586 €	635 €
<b>VIDRIO 6MM</b> <b>VIDRO 6MM</b>	Affumicato, Bronce, Mate, Transp. decorado	610 €	671 €	733 €	794 €
	Affumicato decorado Bronce decorado Nuevos / Novos decorados *	683 €	752 €	820 €	889 €
ENTRADA MÍNIMA CON UÑERO mm		452	485	520	520
ENTRADA MÍNIMO COM PUXADOR INTEGRADO mm					

		B mm			
		700-800	801-900	901-1000	1001-1200
<b>PERFIL BRILLO - NEGRO MATE</b> <b>PERFIL BRILHO - PRETO MATE</b>					
	Transparente	488 €	537 €	586 €	635 €
<b>VIDRIO 6MM</b> <b>VIDRO 6MM</b>	Affumicato, Bronce, Mate, Transp. decorado	610 €	671 €	733 €	794 €
	Affumicato decorado Bronce decorado Nuevos / Novos decorados *	683 €	752 €	820 €	889 €
ENTRADA MÍNIMA CON UÑERO mm		452	485	520	520
ENTRADA MÍNIMO COM PUXADOR INTEGRADO mm					

\* Para serigrafías digitales confirmar precio con ATC. / Para serigrafias digitais confirmar preço com ATC.

## VIDRIO Y DECORADO VIDRO E DECORADO



## NUEVOS DECORADOS NOVOS DECORADOS



# suite

SC2 | MAMPARA DE DUCHA: 1 PUERTA CORREDERA Y 1 FIJO ENTRE PAREDES  
 DIVISÓRIA DE DUCHE: 1 PORTA DE CORRER E 1 FIXO ENTRE PAREDE

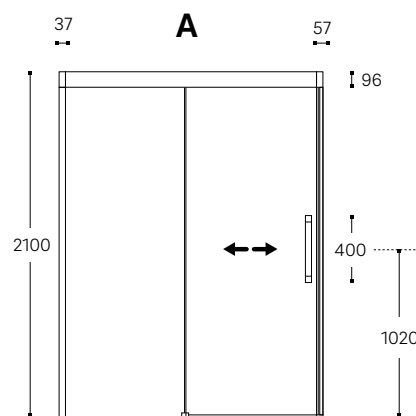

Dimensiones en mm.  
 Dimensões em mm.



VIDRIO TEMPLADO  
 VIDRO TEMPERADO  
**8 MM**



SOFT-CLOSE  
 SOFTCLOSE



COMPENSACIÓN A CADA LADO  
 COMPENSAÇÃO A CADA LADO  
**15 MM**



TRATAMIENTO INCLUIDO  
 TRATAMENTO INCLUIDO



MEDIDAS Y ALTURAS ESPECIALES  
 MEDIDAS E ALTURAS ESPECIAIS  
**HASTA / ATÉ 2500 MM**  
 (VER PÁG. / CONSULTA A PÁG. **372**)



ALTURA ESTÁNDAR  
 ALTURA NORMA  
**2100 MM**  
 ALTURA ESPECIAL  
 ALTURA ESTÁNDAR  
**HASTA / ATÉ 2500 MM**



TIRADOR  
 PUXADOR  
**400-700 MM**



TOALLERO OPCIONAL  
 TOALHEIRO OPCIONAL  
**400-700 MM**



MONTAJE  
 MONTAJEM  
**120 € \***

\* Precio recomendado  
 Código montaje **CSM10**  
 Para desplazamientos  
 consultar pág. **373**

\* Preço recomendado  
 Código montagem **CSM10**  
 Para deslocações  
 consultar pág. **373**

## ACABADOS METÁLICOS ACABAMENTOS METÁLICOS



BRILLO  
 BRILHO



NEGRO MATE  
 PRETO MATE



INOX MATE  
 INOX MATE

## TIRADOR PUXADOR



400 MM  
 500 MM  
 600 MM  
 700 MM



## SC2 | FRONTAL

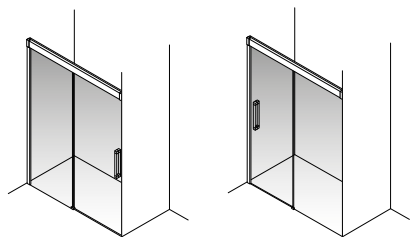

**L** IZQUIERDA  
ESQUERDA

**R** DERECHA  
DIREITA

APERTURA / ABERTURA

Estos precios incluyen un tirador de 400mm en el mismo acabado que el perfil de la mampara.

Estes valores incluem um puxador de 400mm do mesmo acabamento do perfil da divisória.

\*\* Ver página 371 para más información de cómo solicitar el toallero opcional.

\*\* Consulta a página 371 para mais informações sobre como solicitar o toalheiro opcional.

		A mm			
		1200-1400	1401-1600	1601-1800	1801-2000
<b>PERFIL BRILLO</b> <b>PERFIL BRILHO</b>					
	Transparente	1.095 €	1.190 €	1.285 €	1.381 €
VIDRIO VIDRO	Affumicato, Bronce, Mate, Transp. decorado	1.314 €	1.428 €	1.542 €	1.657 €
	Affumicato decorado Bronce decorado Transp. Nuevos / Novos decorados *	1.478 €	1.607 €	1.735 €	1.864 €
	<b>PERFIL INOX MATE - NEGRO MATE</b> <b>PERFIL INOX MATE - PRETO MATE</b>				
	Transparente	1.349 €	1.467 €	1.579 €	1.697 €
VIDRIO VIDRO	Affumicato, Bronce, Mate, Transp. decorado	1.619 €	1.760 €	1.895 €	2.036 €
	Affumicato decorado Bronce decorado Nuevos / Novos decorados *	1.821 €	1.980 €	2.132 €	2.291 €
	ENTRADA MÍNIMA mm / ENTRADA MÍNIMO mm	515	615	715	815

<b>TIRADOR PARA PUERTA mm</b> <b>PUXADOR PARA PORTA mm</b>		400	500	600	700
BRILLO BRILHO	Incluido / Incluso		+17 €	+33 €	+50 €
INOX MATE / NEGRO MATE INOX MATE / PRETO MATE	Incluido / Incluso		+17 €	+33 €	+50 €
<b>TOALLERO OPCIONAL mm</b> <b>TOALHEIRO OPCIONAL mm</b>		400	500	600	700
BRILLO BRILHO		+83 €	+94 €	+105 €	+116 €
INOX MATE / NEGRO MATE INOX MATE / PRETO MATE		+83 €	+94 €	+105 €	+116 €
MEDIDAS FRONTAL mm		1200-2000	1401-2000	1601-2000	1801-2000

\* Para serigrafías digitales confirmar precio con ATC. / Para serigrafias digitais confirmar preço com ATC.

### VIDRIO Y DECORADO VIDRO E DECORADO

TRANSP.	AFFUMICATO	BRONCE	MATE
SIN DECORADO	SIN DECORADO	SIN DECORADO	SIN DECORADO
PICTOR	PICTOR	PICTOR	

### NUEVOS DECORADOS NOVOS DECORADOS

SERIGRAFÍAS ESPECIALES		SERIGRAFÍAS DIGITALES	
MIRAI	WETLANDS	BAMBOO	WAVE
GRID		FOG	

# suite

SC7 | MAMPARA DE DUCHA: 1 PUERTA CORREDERA Y 1 FIJO MÁS LATERAL A PUERTA  
 DIVISÓRIA DE DUCHE: 1 PORTA DE CORRER E 1 FIXO MAIS LATERAL A LA PORTA

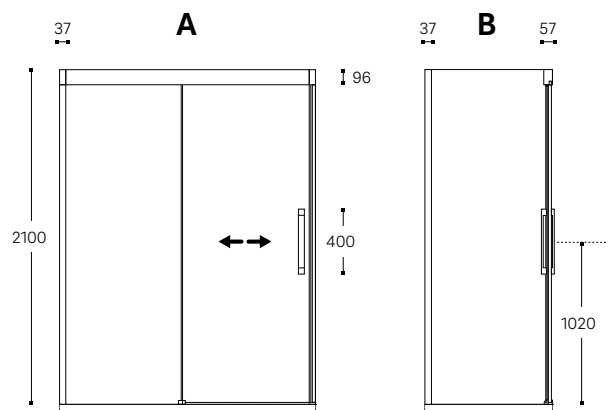

Dimensiones en mm.  
 Dimensões em mm.



VIDRIO TEMPLADO  
 VIDRO TEMPERADO  
**8 MM**



SOFT-CLOSE  
 SOFTCLOSE



COMPENSACIÓN A CADA LADO  
 COMPENSAÇÃO A CADA LADO  
**15 MM**



TRATAMIENTO INCLUIDO  
 TRATAMENTO INCLUIDO



MEDIDAS Y ALTURAS ESPECIALES  
 MEDIDAS E ALTURAS ESPECIAIS  
**HASTA / ATÉ 2500 MM**  
 (VER PÁG. / CONSULTA A PÁG. **372**)



ALTURA ESTÁNDAR  
 ALTURA NORMA  
**2100 MM**  
 ALTURA ESPECIAL  
 ALTURA ESTÁNDAR  
**HASTA / ATÉ 2500 MM**



TIRADOR  
 PUXADOR  
**400-700 MM**



TOALLERO OPCIONAL  
 TOALHEIRO OPCIONAL  
**400-700 MM**



MONTAJE  
 MONTAJEM  
**145 € \***

\* Precio recomendado  
 Código montaje **CSM15**  
 Para desplazamientos  
 consultar pág. **373**

\* Preço recomendado  
 Código montagem **CSM15**  
 Para deslocações  
 consultar pág. **373**

## ACABADOS METÁLICOS ACABAMENTOS METÁLICOS



BRILLO  
 BRILHO



NEGRO MATE  
 PRETO MATE



INOX MATE  
 INOX MATE

## TIRADOR PUXADOR



400 MM  
 500 MM  
 600 MM  
 700 MM

## SC7 | FRONTAL

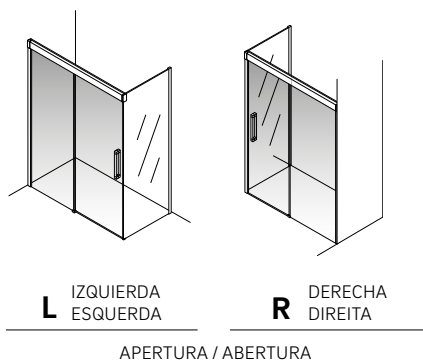

Estos precios incluyen un tirador de 400mm en el mismo acabado que el perfil de la mampara.

Estes valores incluem um puxador de 400mm do mesmo acabamento do perfil da divisória.

\*\* Ver página 371 para más información de cómo solicitar el toallero opcional.

\*\* Consulta a página 371 para mais informações sobre como solicitar o toalheiro opcional.

		A mm			
		1200-1400	1401-1600	1601-1800	1801-2000
<b>PERFIL BRILLO</b>	<b>PERFIL BRILHO</b>				
	Transparente	1.095 €	1.190 €	1.285 €	1.381 €
VIDRIO	Affumicato, Bronce, Mate, Transp. decorado	1.314 €	1.428 €	1.542 €	1.657 €
	Affumicato decorado Bronce decorado Nuevos / Novos decorados *	1.478 €	1.607 €	1.735 €	1.864 €
<b>PERFIL INOX MATE - NEGRO MATE</b>					
<b>PERFIL INOX MATE - PRETO MATE</b>					
	Transparente	1.349 €	1.467 €	1.579 €	1.697 €
VIDRIO	Affumicato, Bronce, Mate, Transp. decorado	1.619 €	1.760 €	1.895 €	2.036 €
	Affumicato decorado Bronce decorado Nuevos / Novos decorados *	1.821 €	1.980 €	2.132 €	2.291 €
ENTRADA MÍNIMA mm / ENTRADA MÍNIMO mm		508	608	708	808

<b>TIRADOR PARA PUERTA mm</b>					
<b>PUXADOR PARA PORTA mm</b>		400	500	600	700
BRILLO	BRILHO	Incluido / Incluso	+17 €	+33 €	+50 €
INOX MATE / NEGRO MATE	INOX MATE / PRETO MATE	Incluido / Incluso	+17 €	+33 €	+50 €
<b>TOALLERO OPCIONAL mm</b>					
<b>TOALHEIRO OPCIONAL mm</b>		400	500	600	700
BRILLO	BRILHO	+83 €	+94 €	+105 €	+116 €
INOX MATE / NEGRO MATE	INOX MATE / PRETO MATE	+83 €	+94 €	+105 €	+116 €
MEDIDAS FRONTAL mm		1200-2000	1401-2000	1601-2000	1801-2000

## SLC | LATERAL

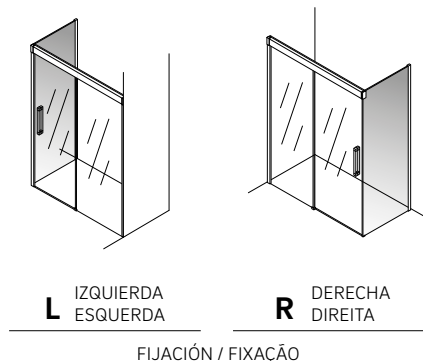

\*\* Ver página 371 para más información de cómo solicitar el toallero opcional.

\*\* Consulta a página 371 para mais informações sobre como solicitar o toalheiro opcional.

		B mm				
		200-500	501-600	601-800	801-1000	1001-1200
<b>PERFIL BRILLO</b>	<b>PERFIL BRILHO</b>					
	Transparente	261 €	299 €	369 €	422 €	475 €
VIDRIO	Affumicato, Bronce, Mate, Transp. decorado	313 €	359 €	443 €	506 €	570 €
	Affumicato decorado Bronce decorado Nuevos / Novos decorados *	352 €	404 €	498 €	570 €	641 €
<b>PERFIL INOX MATE - NEGRO MATE</b>						
<b>PERFIL INOX MATE - PRETO MATE</b>						
	Transparente	326 €	371 €	455 €	522 €	590 €
VIDRIO	Affumicato, Bronce, Mate, Transp. decorado	391 €	445 €	546 €	626 €	708 €
	Affumicato decorado Bronce decorado Nuevos / Novos decorados *	440 €	501 €	614 €	705 €	797 €
<b>TOALLERO OPCIONAL mm</b>						
<b>TOALHEIRO OPCIONAL mm</b>			400	500	600	700
BRILLO	BRILHO	-	+83 €	+94 €	+105 €	+116 €
INOX MATE / NEGRO MATE	INOX MATE / PRETO MATE	-	+83 €	+94 €	+105 €	+116 €
MEDIDAS LATERAL mm		200-500	500-1200	600-1200	700-1200	800-1200

\* Para serigrafías digitales confirmar precio con ATC. / Para serigrafias digitais confirmar preço com ATC.

### VIDRIO Y DECORADO VIDRO E DECORADO



### NUEVOS DECORADOS NOVOS DECORADOS



# suite

SCS | MAMPARA DE DUCHA 1 PUERTA CORREDERA Y 1 FIJO MÁS LATERAL AL FIJO  
 DIVISÓRIA DE DUCHE: 1 PORTA DE CORRER E 1 FIXO MAIS LATERAL AO FIXO

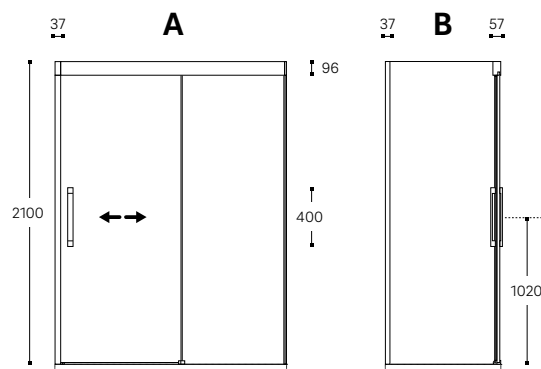

Dimensiones en mm.  
 Dimensões em mm.



VIDRIO TEMPLADO  
 VIDRO TEMPERADO  
**8 MM**



SOFT-CLOSE  
 SOFTCLOSE



COMPENSACIÓN A CADA LADO  
 COMPENSAÇÃO A CADA LADO  
**15 MM**



TRATAMIENTO INCLUIDO  
 TRATAMENTO INCLUIDO



MEDIDAS Y ALTURAS ESPECIALES  
 MEDIDAS E ALTURAS ESPECIAIS  
**HASTA / ATÉ 2500 MM**  
 (VER PÁG. / CONSULTA A PÁG. **372**)



ALTURA ESTÁNDAR  
 ALTURA NORMA  
**2100 MM**  
 ALTURA ESPECIAL  
 ALTURA ESTÁNDAR  
**HASTA / ATÉ 2500 MM**



TIRADOR  
 PUXADOR  
**400-700 MM**



TOALLERO OPCIONAL  
 TOALHEIRO OPCIONAL  
**400-700 MM**



MONTAJE  
 MONTAJEM  
**145 € \***

\* Precio recomendado  
 Código montaje **CSM15**  
 Para desplazamientos  
 consultar pág. **373**

\* Preço recomendado  
 Código montagem **CSM15**  
 Para deslocações  
 consultar pág. **373**

## ACABADOS METÁLICOS ACABAMENTOS METÁLICOS



BRILLO  
 BRILHO



NEGRO MATE  
 PRETO MATE



INOX MATE  
 INOX MATE

## TIRADOR PUXADOR



400 MM  
 500 MM  
 600 MM  
 700 MM

## SCS | FRONTAL

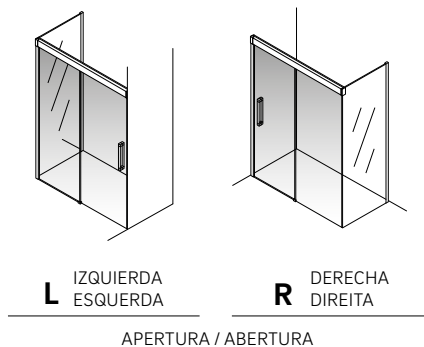

Estos precios incluyen un tirador de 400mm en el mismo acabado que el perfil de la mampara.

Estes valores incluem um puxador de 400mm do mesmo acabamento do perfil da divisória.

\*\* Ver página 371 para más información de cómo solicitar el toallero opcional.

\*\* Consulta a página 371 para mais informações sobre como solicitar o toalheiro opcional.

		A mm			
		1200-1400	1401-1600	1601-1800	1801-2000
<b>PERFIL BRILLO</b> <b>PERFIL BRILHO</b>					
	Transparente	1.095 €	1.190 €	1.285 €	1.381 €
VIDRIO VIDRO	Affumicato, Bronce, Mate, Transp. decorado	1.314 €	1.428 €	1.542 €	1.657 €
	Affumicato decorado Bronce decorado Nuevos / Novos decorados *	1.478 €	1.607 €	1.735 €	1.864 €
<b>PERFIL INOX MATE - NEGRO MATE</b> <b>PERFIL INOX MATE - PRETO MATE</b>					
	Transparente	1.349 €	1.467 €	1.579 €	1.697 €
VIDRIO VIDRO	Affumicato, Bronce, Mate, Transp. decorado	1.619 €	1.760 €	1.895 €	2.036 €
	Affumicato decorado Bronce decorado Nuevos / Novos decorados *	1.821 €	1.980 €	2.132 €	2.291 €
ENTRADA MÍNIMA mm / ENTRADA MÍNIMO mm		508	608	708	808

<b>MEDIDA TIRADOR PARA PUERTA mm</b> <b>MEDIDA PUXADOR PARA PORTA mm</b>		400	500	600	700
BRILLO BRILHO	Incluido / Incluso		+17 €	+33 €	+50 €
PERFIL INOX MATE / NEGRO MATE PERFIL INOX MATE / PRETO MATE	Incluido / Incluso		+17 €	+33 €	+50 €
<b>TOALLERO OPCIONAL PARA FRONTAL</b> <b>TOALHEIRO OPCIONAL PARA FRONTAL</b>		400	500	600	700
BRILLO BRILHO		+83 €	+94 €	+105 €	+116 €
INOX MATE / NEGRO MATE INOX MATE / PRETO MATE		+83 €	+94 €	+105 €	+116 €
MEDIDAS FRONTAL mm		1200-2000	1401-2000	1601-2000	1801-2000

## SLC | LATERAL

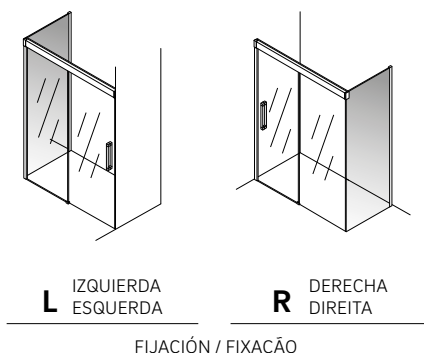

\*\* Ver página 371 para más información de cómo solicitar el toallero opcional.

\*\* Consulta a página 371 para mais informações sobre como solicitar o toalheiro opcional.

		B mm				
		200-500	501-600	601-800	801-1000	1001-1200
<b>PERFIL BRILLO</b> <b>PERFIL BRILHO</b>						
	Transparente	261 €	299 €	369 €	422 €	475 €
VIDRIO VIDRO	Affumicato, Bronce, Mate, Transp. decorado	313 €	359 €	443 €	506 €	570 €
	Affumicato decorado Bronce decorado Nuevos / Novos decorados *	352 €	404 €	498 €	570 €	641 €
<b>PERFIL INOX MATE - NEGRO MATE</b> <b>PERFIL INOX MATE - PRETO MATE</b>						
	Transparente	326 €	371 €	455 €	522 €	590 €
VIDRIO VIDRO	Affumicato, Bronce, Mate, Transp. decorado	391 €	445 €	546 €	626 €	708 €
	Affumicato decorado Bronce decorado Nuevos / Novos decorados *	440 €	501 €	614 €	705 €	797 €
<b>TOALLERO OPCIONAL mm</b> <b>TOALHEIRO OPCIONAL mm</b>			400	500	600	700
BRILLO BRILHO		-	+83 €	+94 €	+105 €	+116 €
INOX MATE / NEGRO MATE INOX MATE / PRETO MATE		-	+83 €	+94 €	+105 €	+116 €
MEDIDAS LATERAL mm		200-500	500-1200	600-1200	700-1200	800-1200

\* Para serigrafías digitales confirmar precio con ATC. / Para serigrafias digitais confirmar preço com ATC.

### VIDRIO Y DECORADO VIDRO E DECORADO



### NUEVOS DECORADOS NOVOS DECORADOS



# suite

SC3 | MAMPARA DE DUCHA: 1 PUERTA CORREDERA Y 2 FIJOS ENTRE PAREDES  
 DIVISÓRIA DE DUCHE: 1 PORTA DE CORRER E 2 FIXOS ENTRE PAREDE

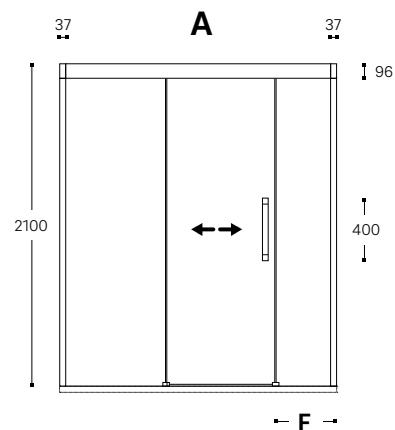

Medida del FIJO configurable según las necesidades del consumidor.  
 Medida del fijo configurável según la necessidade do consumidor.

Dimensiones en mm.  
 Dimensões em mm.



VIDRIO TEMPLADO  
 VIDRO TEMPERADO  
**8 MM**



SOFT-CLOSE  
 SOFTCLOSE



COMPENSACIÓN A CADA LADO  
 COMPENSAÇÃO A CADA LADO  
**15 MM**



TRATAMIENTO INCLUIDO  
 TRATAMENTO INCLUIDO



MEDIDAS Y ALTURAS ESPECIALES  
 MEDIDAS E ALTURAS ESPECIAIS  
**HASTA / ATÉ 2500 MM**  
 (VER PÁG. / CONSULTA A PÁG. 372)



ALTURA ESTÁNDAR  
 ALTURA NORMA  
**2100 MM**  
 ALTURA ESPECIAL  
 ALTURA ESTÁNDAR  
**HASTA / ATÉ 2500 MM**



TIRADOR  
 PUXADOR  
**400-700 MM**



TOALLERO OPCIONAL  
 TOALHEIRO OPCIONAL  
**400-700 MM**



MONTAJE  
 MONTAJEM  
**125 € \***

\* Precio recomendado  
 Código montaje **CSM11**  
 Para desplazamientos  
 consultar pág. **373**

\* Preço recomendado  
 Código montagem **CSM11**  
 Para deslocações  
 consultar pág. **373**

## ACABADOS METÁLICOS ACABAMENTOS METÁLICOS



BRILLO  
 BRILHO



NEGRO MATE  
 PRETO MATE



INOX MATE  
 INOX MATE

## TIRADOR PUXADOR



400 MM  
 500 MM  
 600 MM  
 700 MM

## SC3 | FRONTAL

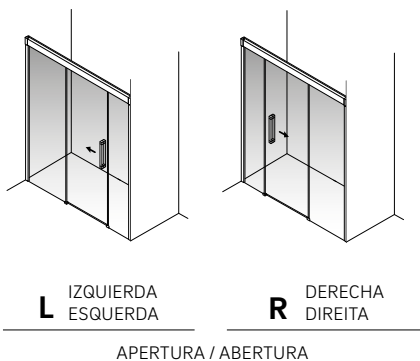

Estos precios incluyen un tirador de 400mm en el mismo acabado que el perfil de la mampara.

Estes valores incluem um puxador de 400mm do mesmo acabamento do perfil da divisória.

\*\* Ver página 371 para más información de cómo solicitar el toallero opcional.

\*\* Consulta a página 371 para mais informações sobre como solicitar o toalheiro opcional.

		A mm		
		1400-1600	1601-1800	1801-2000
<b>PERFIL BRILLO PERFIL BRILHO</b>				
	Transparente	1.229 €	1.341 €	1.454 €
VIDRIO VIDRO	Affumicato, Bronce, Mate, Transp. decorado	1.475 €	1.609 €	1.745 €
	Affumicato decorado Bronce decorado Nuevos / Novos decorados *	1.659 €	1.810 €	1.963 €
	<b>PERFIL INOX MATE - NEGRO MATE PERFIL INOX MATE - PRETO MATE</b>			
	Transparente	1.515 €	1.650 €	1.790 €
VIDRIO VIDRO	Affumicato, Bronce, Mate, Transp. decorado	1.818 €	1.980 €	2.148 €
	Affumicato decorado Bronce decorado Nuevos / Novos decorados *	2.045 €	2.228 €	2.417 €

<b>TIRADOR PARA PUERTA mm PUXADOR PARA PORTA mm</b>	<b>400</b>	<b>500</b>	<b>600</b>	<b>700</b>
BRILLO BRILHO	Incluido / Incluso	+17 €	+33 €	+50 €
INOX MATE / NEGRO MATE INOX MATE / PRETO MATE	Incluido / Incluso	+17 €	+33 €	+50 €
<b>TOALLERO OPCIONAL mm TOALHEIRO OPCIONAL mm</b>				
BRILLO BRILHO	+83 €	+94 €	+105 €	-
INOX MATE / NEGRO MATE INOX MATE / PRETO MATE	+83 €	+94 €	+105 €	-
MÁX. TOALLERO / MÁX. TOALHEIRO mm	1400-2000	1601-2000	1801-2000	-

\* Para serigrafías digitales confirmar precio con ATC. / Para serigrafias digitais confirmar preço com ATC.

### VIDRIO Y DECORADO VIDRO E DECORADO

TRANSP.	AFFUMICATO	BRONCE	MATE
SIN DECORADO	SIN DECORADO	SIN DECORADO	SIN DECORADO
PICTOR	PICTOR	PICTOR	

### NUEVOS DECORADOS NOVOS DECORADOS

SERIGRAFÍAS ESPECIALES		SERIGRAFÍAS DIGITALES	
MIRAI	WETLANDS	BAMBOO	WAVE
GRID		FOG	

# suite

SC4 | MAMPARA DE DUCHA: 2 PUERTAS CORREDERAS Y 2 FIJOS ENTRE PAREDES  
 DIVISÓRIA DE DUCHE 2 PORTA DE CORRER E 2 FIXOS ENTRE PAREDE

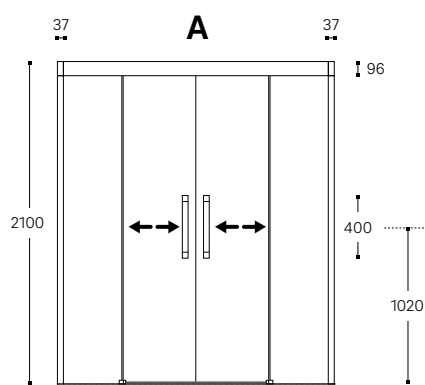

Dimensiones en mm.  
 Dimensões em mm.



VIDRIO TEMPLADO  
 VIDRO TEMPERADO  
**8 MM**



SOFT-CLOSE  
 SOFTCLOSE



COMPENSACIÓN A CADA LADO  
 COMPENSAÇÃO A CADA LADO  
**15 MM**



TIRADOR  
 PUXADOR  
**400-700 MM**



MEDIDAS Y ALTURAS ESPECIALES  
 MEDIDAS E ALTURAS ESPECIAIS  
**HASTA / ATÉ 2500 MM**  
 (VER PÁG. / CONSULTA A PÁG. **372**)



ALTURA ESTÁNDAR  
 ALTURA NORMA  
**2100 MM**  
 ALTURA ESPECIAL  
 ALTURA ESTÁNDAR  
**HASTA / ATÉ 2500 MM**



MONTAJE  
 MONTAJEM  
**130 € \***

\* Precio recomendado  
 Código montaje **CSM12**  
 Para desplazamientos  
 consultar pág. **373**

\* Preço recomendado  
 Código montagem **CSM12**  
 Para deslocações  
 consultar pág. **373**

## ACABADOS METÁLICOS ACABAMENTOS METÁLICOS



BRILLO  
 BRILHO



NEGRO MATE  
 PRETO MATE



INOX MATE  
 INOX MATE

## TIRADOR PUXADOR



400 MM  
 500 MM  
 600 MM  
 700 MM



## SC4 | FRONTAL

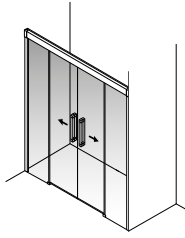

Estos precios incluyen un tirador de 400mm en el mismo acabado que el perfil de la mampara.

Estes valores incluem um puxador de 400mm do mesmo acabamento do perfil da divisória.

		<b>A mm</b>		
		<b>1400-1600</b>	<b>1601-1800</b>	<b>1801-2000</b>
<b>PERFIL BRILLO PERFIL BRILHO</b>				
	Transparente	1.454 €	1.555 €	1.656 €
VIDRIO VIDRO	Affumicato, Bronce, Mate, Transp. decorado	1.745 €	1.866 €	1.987 €
	Affumicato decorado Bronce decorado Nuevos / Novos decorados *	1.963 €	2.099 €	2.236 €
	<b>PERFIL INOX MATE - NEGRO MATE PERFIL INOX MATE - PRETO MATE</b>			
	Transparente	1.789 €	1.915 €	2.039 €
VIDRIO VIDRO	Affumicato, Bronce, Mate, Transp. decorado	2.147 €	2.298 €	2.447 €
	Affumicato decorado Bronce decorado Nuevos / Novos decorados *	2.415 €	2.585 €	2.753 €
	ENTRADA MÍNIMA mm / ENTRADA MÍNIMO mm	608	708	808

<b>TIRADORES PARA PUERTAS (2 UDS) PUXADORES PARA PORTAS (2 UDS)</b>		<b>400</b>	<b>500</b>	<b>600</b>	<b>700</b>
BRILLO BRILHO	Incluido / Incluso	+33 €	+66 €	+99 €	+99 €
INOX MATE / NEGRO MATE INOX MATE / PRETO MATE	Incluido / Incluso	+33 €	+66 €	+99 €	+99 €

\* Para serigrafías digitales confirmar precio con ATC. / Para serigrafias digitais confirmar preço com ATC.

### VIDRIO Y DECORADO VIDRO E DECORADO

TRANSP.	AFFUMICATO	BRONCE	MATE
SIN DECORADO	SIN DECORADO	SIN DECORADO	SIN DECORADO
PICTOR	PICTOR	PICTOR	

### NUEVOS DECORADOS NOVOS DECORADOS

SERIGRAFÍAS ESPECIALES		SERIGRAFÍAS DIGITALES	
MIRAI	WETLANDS	BAMBOO	WAVE
GRID		FOG	

# suite

SC9 | MAMPARA DE DUCHA: 2 PUERTAS CORREDERAS Y 2 FIJOS MÁS LATERAL  
DIVISÓRIA DE DUCHE: 2 PORTA DE CORRER E 2 FIXOS MAIS LATERAL

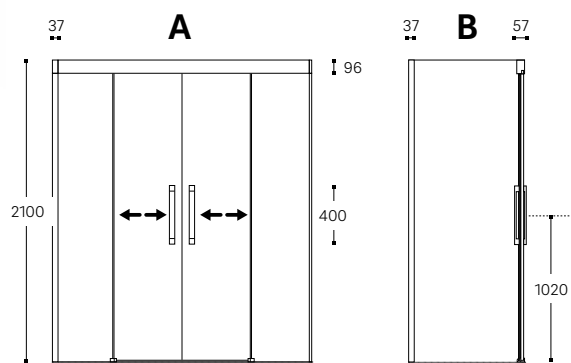

Dimensiones en mm.  
Dimensões em mm.



VIDRIO TEMPLADO  
VIDRO TEMPERADO  
**8** MM



COMPENSACIÓN A CADA LADO  
COMPENSAÇÃO A CADA LADO  
**15** MM



TRATAMIENTO INCLUIDO  
TRATAMENTO INCLUIDO



TIRADOR  
PUXADOR  
**400-700** MM



MEDIDAS Y ALTURAS ESPECIALES  
MEDIDAS E ALTURAS ESPECIAIS  
**HASTA / ATÉ 2500** MM  
(VER PÁG. / CONSULTA A PÁG. **372**)



ALTURA ESTÁNDAR  
ALTURA NORMA  
**2100** MM  
ALTURA ESPECIAL  
ALTURA ESTÁNDAR  
**HASTA / ATÉ 2500** MM



TOALLERO OPCIONAL  
TOALHEIRO OPCIONAL  
**400-700** MM



MONTAJE  
MONTAJEM  
**155** € \*

\* Precio recomendado  
Código montaje **CSM17**  
Para desplazamientos  
consultar pág. **373**

\* Preço recomendado  
Código montagem **CSM17**  
Para deslocações  
consultar pág. **373**

## ACABADOS METÁLICOS ACABAMENTOS METÁLICOS



BRILLO  
BRILHO



NEGRO MATE  
PRETO MATE



INOX MATE  
INOX MATE

## TIRADOR PUXADOR



400 MM  
500 MM  
600 MM  
700 MM

## SC9 | FRONTAL

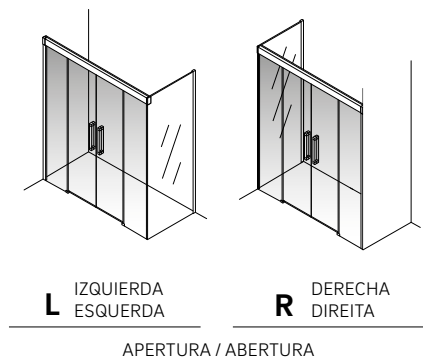

Estos precios incluyen un tirador de 400mm en el mismo acabado que el perfil de la mampara.  
Estes valores incluem um puxador de 400mm do mesmo acabamento do perfil da divisória.

		A mm		
PERFIL BRILLO PERFIL BRILHO		1400-1600	1601-1800	1801-2000
	Transparente	1.454 €	1.555 €	1.656 €
VIDRIO VIDRO	Affumicato, Bronce, Mate, Transp. decorado	1.745 €	1.866 €	1.987 €
	Affumicato decorado Bronce decorado Nuevos / Novos decorados *	1.963 €	2.099 €	2.236 €
	<b>PERFIL INOX MATE - NEGRO MATE PERFIL INOX MATE - PRETO MATE</b>			
	Transparente	1.790 €	1.915 €	2.039 €
VIDRIO VIDRO	Affumicato, Bronce, Mate, Transp. decorado	2.148 €	2.298 €	2.447 €
	Affumicato decorado Bronce decorado Nuevos / Novos decorados *	2.417 €	2.585 €	2.753 €
	ENTRADA MÍNIMA mm / ENTRADA MÍNIMO mm	608	708	808

TIRADORES PARA PUERTAS (2 UDS) PUXADORES PARA PORTAS (2 UDS)		400	500	600	700
BRILLO BRILHO	Incluido / Incluso	+33 €	+66 €	+99 €	+99 €
INOX MATE / NEGRO MATE INOX MATE / PRETO MATE	Incluido / Incluso	+33 €	+66 €	+99 €	+99 €

## SLC | LATERAL

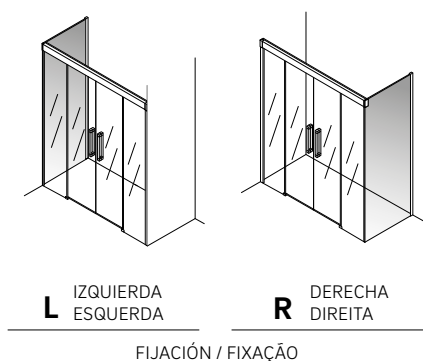

\*\* Ver página 371 para más información de cómo solicitar el toallero opcional.

\*\* Consulta a página 371 para mais informações sobre como solicitar o toalheiro opcional.

		B mm				
PERFIL BRILLO PERFIL BRILHO		200-500	501-600	601-800	801-1000	1001-1200
	Transparente	261 €	299 €	369 €	422 €	475 €
VIDRIO VIDRO	Affumicato, Bronce, Mate, Transp. decorado	313 €	359 €	443 €	506 €	570 €
	Affumicato decorado Bronce decorado Nuevos / Novos decorados *	352 €	404 €	498 €	570 €	641 €
	<b>PERFIL INOX MATE - NEGRO MATE PERFIL INOX MATE - PRETO MATE</b>					
	Transparente	326 €	371 €	455 €	522 €	590 €
VIDRIO VIDRO	Affumicato, Bronce, Mate, Transp. decorado	391 €	445 €	546 €	626 €	708 €
	Affumicato decorado Bronce decorado Nuevos / Novos decorados *	440 €	501 €	614 €	705 €	797 €

TOALLERO OPCIONAL mm TOALHEIRO OPCIONAL mm		400	500	600	700	
BRILLO BRILHO	-	+83 €	+94 €	+105 €	+116 €	
INOX MATE / NEGRO MATE INOX MATE / PRETO MATE	-	+83 €	+94 €	+105 €	+116 €	
MEDIDAS LATERAL mm		200-500	501-1200	601-1200	801-1200	1001-1200

\* Para serigrafías digitales confirmar precio con ATC. / Para serigrafias digitais confirmar preço com ATC.

### VIDRIO Y DECORADO VIDRO E DECORADO



### NUEVOS DECORADOS NOVOS DECORADOS



# plus

**PC2** | MAMPARA DE DUCHA: 1 PUERTA CORREDERA Y 1 FIJO ENTRE PAREDES  
 DIVISÓRIA DE DUCHE: 1 PORTA DE CORRER E 1 FIXO ENTRE PAREDE

**PB2** | MAMPARA DE BAÑERA: 1 PUERTA CORREDERA Y 1 FIJO ENTRE PAREDES  
 DIVISÓRIA DE BANHEIRA: 1 PORTA DE CORRER E 1 FIXO ENTRE PAREDE

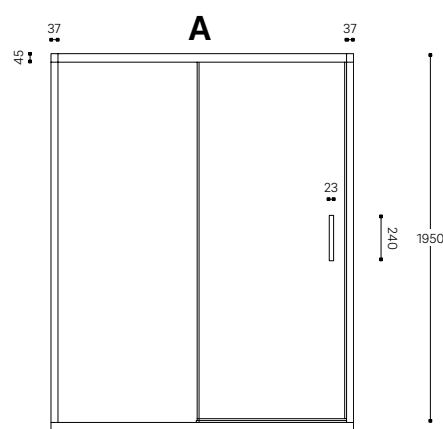

Dimensiones en mm.  
 Dimensões em mm.



VIDRIO TEMPLADO  
 VIDRO TEMPERADO  
**6 MM**



COMPENSACIÓN  
 COMPENSAÇÃO  
**15 MM**



ALTURA MODELO DUCHA  
 ALTURA MODELO DUCHE  
**1950 MM**



ALTURA MODELO BAÑERA  
 ALTURA DO MODELO BANHEIRA  
**1500 MM**



MEDIDAS Y ALTURAS ESPECIALES  
 MEDIDAS E ALTURAS ESPECIAIS  
 (VER PÁG. / CONSULTA A PÁG. **372**)



PUERTAS DESMONTABLES,  
**FÁCIL LIMPIEZA**  
 PORTAS REMOVÍVEIS,  
**FÁCIL LIMPEZA**



TRATAMIENTO OPCIONAL (M)  
 TRATAMENTO OPCIONAL (M)  
**65 €**



MONTAJE  
 MONTAJEM  
**95 € \***

\* Precio recomendado  
 Código montaje **CSM05**  
 Para desplazamientos  
 consultar pág. **373**

\* Preço recomendado  
 Código montagem **CSM05**  
 Para deslocações  
 consultar pág. **373**

## ACABADOS METÁLICOS ACABAMENTOS METÁLICOS



BLANCO  
 BRANCO



PLATA BRILLO  
 PRATA BRILHO



PLATA MATE  
 PRATA MATE

## PC2 | DUCHA DUCHE

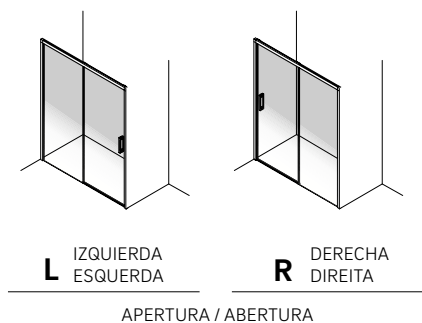

		A mm			
PERFIL BLANCO - PLATA BRILLO - PLATA MATE PERFIL BRANCO - PRATA BRILHO - PRATA MATE		1000-1100	1101-1300	1301-1600	1601-2000
VIDRIO VIDRO	Transparente	674 €	718 €	762 €	805 €
	Affumicato, Bronce, Mate, Transp. decorado	843 €	898 €	953 €	1.006 €
	Affumicato decorado Bronce decorado Nuevos / Novos decorados *	944 €	1.005 €	1.067 €	1.127 €
ENTRADA MÍNIMA mm / ENTRADA MÍNIMO mm		384	435	535	685

## PB2 | BAÑERA BANHEIRA

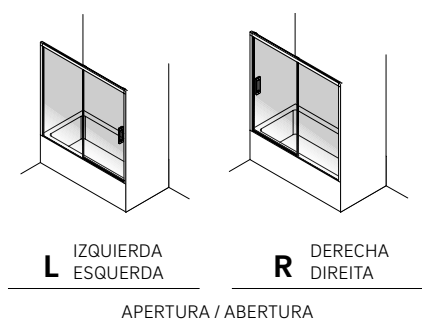

		A mm			
PERFIL BLANCO - PLATA BRILLO - PLATA MATE PERFIL BRANCO - PRATA BRILHO - PRATA MATE		1000-1100	1101-1300	1301-1600	1601-2000
VIDRIO VIDRO	Transparente	612 €	649 €	687 €	724 €
	Affumicato, Bronce, Mate, Transp. decorado	765 €	811 €	859 €	905 €
	Affumicato decorado Bronce decorado Nuevos / Novos decorados *	857 €	909 €	962 €	1.014 €
ENTRADA MÍNIMA mm / ENTRADA MÍNIMO mm		384	435	535	685

\* Para serigrafías digitales confirmar precio con ATC. / Para serigrafias digitais confirmar preço com ATC.

### VIDRIO Y DECORADO VIDRO E DECORADO



### NUEVOS DECORADOS NOVOS DECORADOS



# plus

**PC7** | MAMPARA DE DUCHA: 1 PUERTA CORREDERA Y 1 FIJO MÁS LATERAL  
 DIVISÓRIA DE DUCHE: 1 PORTA DE CORRER E 1 FIXO MAIS LATERAL

**PB7** | MAMPARA DE BAÑERA: 1 PUERTA CORREDERA Y 1 FIJO MÁS LATERAL  
 DIVISÓRIA DE BANHEIRA: 1 PORTA DE CORRER E 1 FIXO MAIS LATERAL

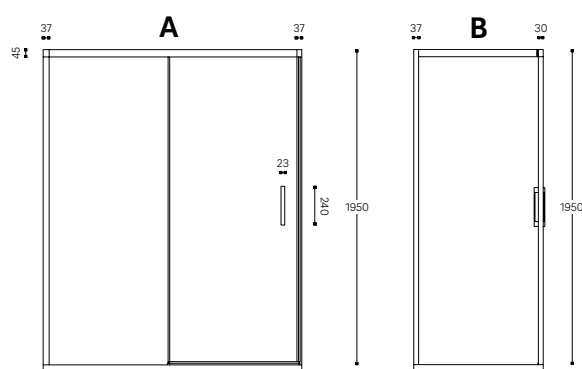

Dimensiones en mm.  
 Dimensões em mm.



VIDRIO TEMPLADO  
 VIDRO TEMPERADO  
**6** MM



COMPENSACIÓN  
 COMPENSAÇÃO  
**15** MM



ALTURA MODELO DUCHA  
 ALTURA MODELO DUCHE  
**1950** MM



ALTURA MODELO BAÑERA  
 ALTURA DO MODELO BANHEIRA  
**1500** MM



MEDIDAS Y ALTURAS ESPECIALES  
 MEDIDAS E ALTURAS ESPECIAIS  
 (VER PÁG. / CONSULTA A PÁG. **372**)



PUERTAS DESMONTABLES,  
**FÁCIL LIMPIEZA**  
 PORTAS REMOVÍVEIS,  
**FÁCIL LIMPEZA**



TRATAMIENTO OPCIONAL (M)  
 TRATAMENTO OPCIONAL (M)  
 FRONTAL **65** € - LATERAL **35** €



MONTAJE  
 MONTAJEM  
**120** € \*

\* Precio recomendado  
 Código montaje **CSM10**  
 Para desplazamientos  
 consultar pág. **373**

\* Preço recomendado  
 Código montagem **CSM10**  
 Para deslocações  
 consultar pág. **373**

## ACABADOS METÁLICOS ACABAMENTOS METÁLICOS



BLANCO  
 BRANCO



PLATA BRILLO  
 PRATA BRILHO



PLATA MATE  
 PRATA MATE

## PC7 | FRONTAL DUCHA FRONTAL DUCHE

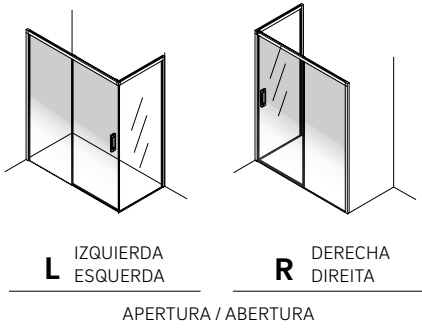

		A mm			
PERFIL BLANCO - PLATA BRILLO - PLATA MATE PERFIL BRANCO - PRATA BRILHO - PRATA MATE		1000-1100	1101-1300	1301-1600	1601-2000
VIDRIO VIDRO	Transparente	674 €	718 €	762 €	805 €
	Affumicato, Bronce, Mate, Transp. decorado	843 €	898 €	953 €	1.006 €
	Affumicato decorado Bronce decorado Nuevos / Novos decorados *	944 €	1.005 €	1.067 €	1.127 €
ENTRADA MÍNIMA mm / ENTRADA MÍNIMO mm		388	438	538	688

## PLC | LATERAL DUCHA LATERAL DUCHE

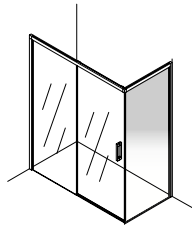

		B mm			
PERFIL BLANCO - PLATA BRILLO - PLATA MATE PERFIL BRANCO - PRATA BRILHO - PRATA MATE		200-400	401-600	601-800	801-1000
VIDRIO VIDRO	Transparente	216 €	246 €	278 €	307 €
	Affumicato, Bronce, Mate, Transp. decorado	270 €	308 €	348 €	384 €
	Affumicato decorado Bronce decorado Nuevos / Novos decorados *	302 €	344 €	389 €	430 €

## PB7 | FRONTAL BAÑERA FRONTAL BANHEIRA

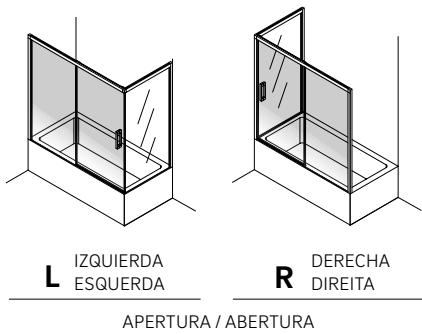

		A mm			
PERFIL BLANCO - PLATA BRILLO - PLATA MATE PERFIL BRANCO - PRATA BRILHO - PRATA MATE		1000-1100	1101-1300	1301-1600	1601-2000
VIDRIO VIDRO	Transparente	612 €	649 €	687 €	724 €
	Affumicato, Bronce, Mate, Transp. decorado	765 €	811 €	859 €	905 €
	Affumicato decorado Bronce decorado Nuevos / Novos decorados *	857 €	909 €	962 €	1.014 €
ENTRADA MÍNIMA mm / ENTRADA MÍNIMO mm		388	438	538	688

## PLG | LATERAL BAÑERA LATERAL BANHEIRA

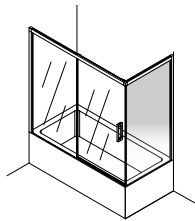

		B mm			
PERFIL BLANCO - PLATA BRILLO - PLATA MATE PERFIL BRANCO - PRATA BRILHO - PRATA MATE		200-400	401-600	601-800	801-1000
VIDRIO VIDRO	Transparente	192 €	223 €	254 €	283 €
	Affumicato, Bronce, Mate, Transp. decorado	240 €	279 €	318 €	354 €
	Affumicato decorado Bronce decorado Nuevos / Novos decorados *	269 €	312 €	356 €	396 €

\* Para serigrafías digitales confirmar precio con ATC. / Para serigrafias digitais confirmar preço com ATC.

### VIDRIO Y DECORADO VIDRO E DECORADO



### NUEVOS DECORADOS NOVOS DECORADOS



# plus

**PCS** | MAMPARA DE DUCHA: 1 PUERTA CORREDERA Y 1 FIJO MÁS LATERAL  
 DIVISÓRIA DE DUCHE: 1 PORTA DE CORRER E 1 FIXO MAIS LATERAL

**PBS** | MAMPARA DE BAÑERA: 1 PUERTA CORREDERA Y 1 FIJO MÁS LATERAL  
 DIVISÓRIA DE BANHEIRA: 1 PORTA DE CORRER E 1 FIXO MAIS LATERAL

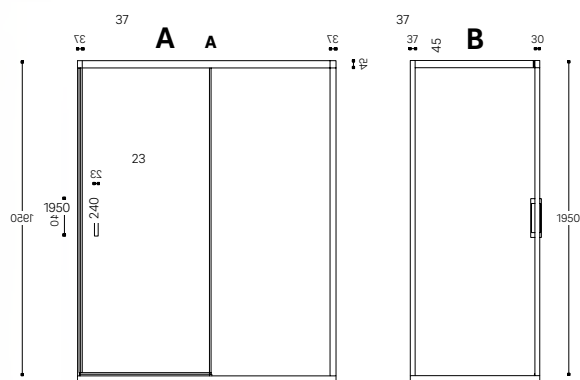

Dimensiones en mm.  
 Dimensões em mm.



VIDRIO TEMPLADO  
 VIDRO TEMPERADO  
**6 MM**



COMPENSACIÓN  
 COMPENSAÇÃO  
**15 MM**



ALTURA MODELO DUCHA  
 ALTURA MODELO DUCHE  
**1950 MM**



ALTURA MODELO BAÑERA  
 ALTURA DO MODELO BANHEIRA  
**1500 MM**



MEDIDAS Y ALTURAS ESPECIALES  
 MEDIDAS E ALTURAS ESPECIAIS  
 (VER PÁG. / CONSULTA A PÁG. **372**)



PUERTAS DESMONTABLES,  
**FÁCIL LIMPIEZA**  
 PORTAS REMOVÍVEIS,  
**FÁCIL LIMPEZA**



TRATAMIENTO OPCIONAL (M)  
 TRATAMENTO OPCIONAL (M)  
 FRONTAL **65 €** - LATERAL **35 €**



MONTAJE  
 MONTAJEM  
**120 € \***

\* Precio recomendado  
 Código montaje **CSM10**  
 Para desplazamientos  
 consultar pág. **373**

\* Preço recomendado  
 Código montagem **CSM10**  
 Para deslocações  
 consultar pág. **373**

## ACABADOS METÁLICOS ACABAMENTOS METÁLICOS



BLANCO  
 BRANCO



PLATA BRILLO  
 PRATA BRILHO



PLATA MATE  
 PRATA MATE



## PCS | FRONTAL DUCHA FRONTAL DUCHE

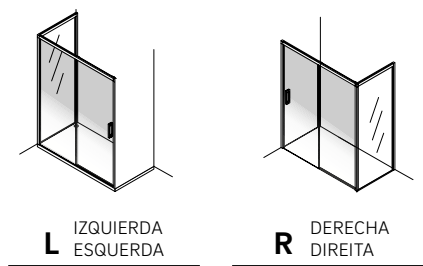

**L** IZQUIERDA  
ESQUERDA

**R** DERECHA  
DIREITA

APERTURA / ABERTURA

		A mm			
PERFIL BLANCO - PLATA BRILLO - PLATA MATE PERFIL BRANCO - PRATA BRILHO - PRATA MATE		1000-1100	1101-1300	1301-1600	1601-2000
VIDRIO VIDRO	Transparente	674 €	718 €	762 €	805 €
	Affumicato, Bronce, Mate, Transp. decorado	843 €	898 €	953 €	1.006 €
	Affumicato decorado Bronce decorado Nuevos / Novos decorados *	944 €	1.005 €	1.067 €	1.127 €
ENTRADA MÍNIMA mm / ENTRADA MÍNIMO mm		388	438	538	688

## PLS | LATERAL DUCHA LATERAL DUCHE

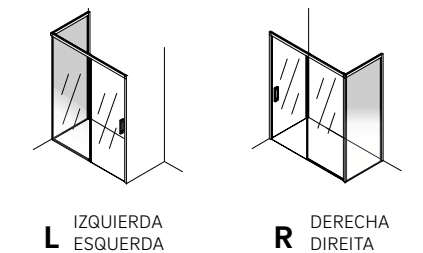

**L** IZQUIERDA  
ESQUERDA

**R** DERECHA  
DIREITA

FIJACIÓN / FIXAÇÃO

		B mm			
PERFIL BLANCO - PLATA BRILLO - PLATA MATE PERFIL BRANCO - PRATA BRILHO - PRATA MATE		200-400	401-600	601-800	801-1000
VIDRIO VIDRO	Transparente	216 €	246 €	278 €	307 €
	Affumicato, Bronce, Mate, Transp. decorado	270 €	308 €	348 €	384 €
	Affumicato decorado Bronce decorado Nuevos / Novos decorados *	302 €	344 €	389 €	430 €

## PBS | FRONTAL BAÑERA FRONTAL BANHEIRA

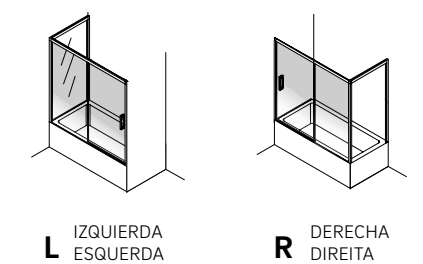

**L** IZQUIERDA  
ESQUERDA

**R** DERECHA  
DIREITA

APERTURA / ABERTURA

		A mm			
PERFIL BLANCO - PLATA BRILLO - PLATA MATE PERFIL BRANCO - PRATA BRILHO - PRATA MATE		1000-1100	1101-1300	1301-1600	1601-2000
VIDRIO VIDRO	Transparente	612 €	649 €	687 €	724 €
	Affumicato, Bronce, Mate, Transp. decorado	756 €	811 €	859 €	905 €
	Affumicato decorado Bronce decorado Nuevos / Novos decorados *	857 €	909 €	962 €	1.014 €
ENTRADA MÍNIMA mm / ENTRADA MÍNIMO mm		388	438	538	688

## PLZ | LATERAL BAÑERA LATERAL BANHEIRA

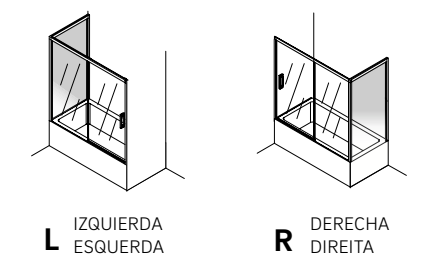

**L** IZQUIERDA  
ESQUERDA

**R** DERECHA  
DIREITA

FIJACIÓN / FIXAÇÃO

		B mm			
PERFIL BLANCO - PLATA BRILLO - PLATA MATE PERFIL BRANCO - PRATA BRILHO - PRATA MATE		200-400	401-600	601-800	801-1000
VIDRIO VIDRO	Transparente	192 €	223 €	254 €	283 €
	Affumicato, Bronce, Mate, Transp. decorado	240 €	279 €	318 €	354 €
	Affumicato decorado Bronce decorado Nuevos / Novos decorados *	269 €	312 €	356 €	396 €

\* Para serigrafías digitales confirmar precio con ATC. / Para serigrafias digitais confirmar preço com ATC.

### VIDRIO Y DECORADO VIDRO E DECORADO



### NUEVOS DECORADOS NOVOS DECORADOS



PC3

MAMPARA DE DUCHA: 1 PUERTA CORREDERA Y 2 SEGMENTOS FIJOS ENTRE PAREDES  
 DIVISÓRIA DE DUCHE: 1 PORTA DE CORRER E 2 FIXOS ENTRE PAREDE

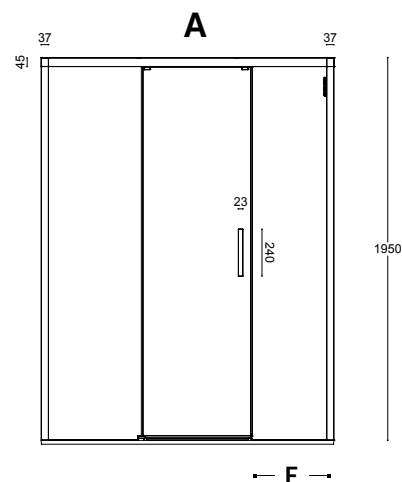

Dimensiones en mm.  
 Dimensões em mm.



VIDRIO TEMPLADO  
 VIDRO TEMPERADO  
**6 MM**



COMPENSACIÓN A CADA LADO  
 COMPENSAÇÃO A CADA LADO  
**15 MM**



ALTURA MODELO DUCHA  
 ALTURA MODELO DUCHE  
**1950 MM**



TRATAMIENTO OPCIONAL (M)  
 TRATAMENTO OPCIONAL (M)  
**85 €**



MEDIDAS Y ALTURAS ESPECIALES  
 MEDIDAS E ALTURAS ESPECIAIS  
 (VER PÁG. / CONSULTA A PÁG. **372**)



PUERTAS DESMONTABLES,  
**FÁCIL LIMPIEZA**  
 PORTAS REMOVÍVEIS,  
**FÁCIL LIMPEZA**



MONTAJE  
 MONTAJEM  
**100 € \***

\* Precio recomendado  
 Código montaje **CSM06**  
 Para desplazamientos  
 consultar pág. **373**

\* Preço recomendado  
 Código montagem **CSM06**  
 Para deslocações  
 consultar pág. **373**

## ACABADOS METÁLICOS ACABAMENTOS METÁLICOS



BLANCO  
 BRANCO



PLATA BRILLO  
 PRATA BRILHO



PLATA MATE  
 PRATA MATE

# PC3 | DUCHA DUCHE

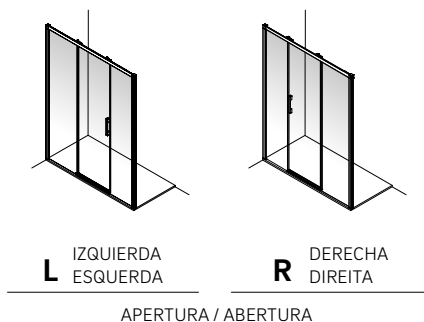

		A mm		
PERFIL BLANCO - PLATA BRILLO - PLATA MATE PERFIL BRANCO - PRATA BRILHO - PRATA MATE		1300-1600	1601-1800	1801-2000
VIDRIO VIDRO	Transparente	784 €	826 €	867 €
	Affumicato, Bronce, Mate, Transp. decorado	980 €	1.033 €	1.084 €
	Affumicato decorado Bronce decorado Nuevos / Novos decorados *	1.098 €	1.156 €	1.214 €

\* Para serigrafías digitales confirmar precio con ATC. / Para serigrafias digitais confirmar preço com ATC.

## VIDRIO Y DECORADO VIDRO E DECORADO



## NUEVOS DECORADOS NOVOS DECORADOS



Stock

Info

**PC4** | MAMPARA DE DUCHA: 2 PUERTAS CORREDERAS Y 2 FIJOS ENTRE PAREDES  
 DIVISÓRIA DE DUCHE: 2 PORTAS DE CORRER E 2 FIXOS ENTRE PAREDE

**PB4** | MAMPARA DE BAÑERA: 2 PUERTAS CORREDERAS Y 2 FIJOS ENTRE PAREDES  
 DIVISÓRIA DE BANHEIRA: 2 PORTAS DE CORRER E 2 FIXOS ENTRE PAREDE

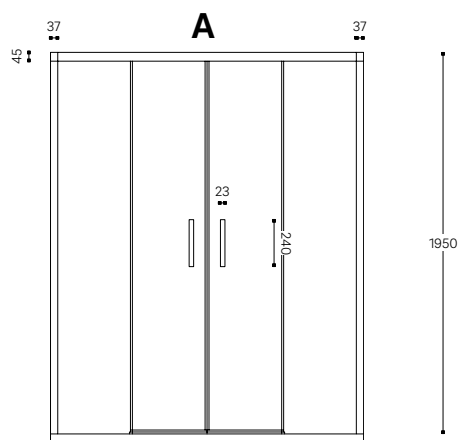

Dimensiones en mm.  
 Dimensões em mm.



VIDRIO TEMPLADO  
 VIDRO TEMPERADO  
**6 MM**



COMPENSACIÓN A CADA LADO  
 COMPENSAÇÃO A CADA LADO  
**15 MM**



ALTURA MODELO DUCHA  
 ALTURA MODELO DUCHE  
**1950 MM**



ALTURA MODELO BAÑERA  
 ALTURA DO MODELO BANHEIRA  
**1500 MM**



MEDIDAS Y ALTURAS ESPECIALES  
 MEDIDAS E ALTURAS ESPECIAIS  
 (VER PÁG. / CONSULTA A PÁG. **372**)



PUERTAS DESMONTABLES,  
**FÁCIL LIMPIEZA**  
 PORTAS REMOVÍVEIS,  
**FÁCIL LIMPEZA**



TRATAMIENTO OPCIONAL (M)  
 TRATAMENTO OPCIONAL (M)  
**95 €**



MONTAJE  
 MONTAJEM  
**105 € \***

\* Precio recomendado  
 Código montaje **CSM07**  
 Para desplazamientos  
 consultar pág. **373**

\* Preço recomendado  
 Código montagem **CSM07**  
 Para deslocações  
 consultar pág. **373**

## ACABADOS METÁLICOS ACABAMENTOS METÁLICOS



BLANCO  
 BRANCO



PLATA BRILLO  
 PRATA BRILHO



PLATA MATE  
 PRATA MATE

## PC4 | DUCHA DUCHE

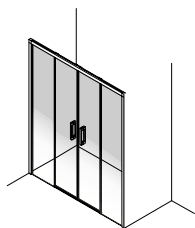

		A mm			
PERFIL BLANCO - PLATA BRILLO - PLATA MATE PERFIL BRANCO - PRATA BRILHO - PRATA MATE		1200-1300	1301-1500	1501-1800	1801-2000
VIDRIO VIDRO	Transparente	790 €	829 €	867 €	905 €
	Affumicato, Bronce, Mate, Transp. decorado	988 €	1.036 €	1.084 €	1.131 €
	Affumicato decorado Bronce decorado Nuevos / Novos decorados *	1.106 €	1.161 €	1.214 €	1.267 €
ENTRADA MÍNIMA mm / ENTRADA MÍNIMO mm		392	442	542	692

## PB4 | BAÑERA BANHEIRA

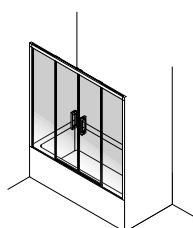

		A mm			
PERFIL BLANCO - PLATA BRILLO - PLATA MATE PERFIL BRANCO - PRATA BRILHO - PRATA MATE		1200-1300	1301-1500	1501-1800	1801-2000
VIDRIO VIDRO	Transparente	824 €	862 €	905 €	943 €
	Affumicato, Bronce, Mate, Transp. decorado	1.030 €	1.078 €	1.131 €	1.179 €
	Affumicato decorado Bronce decorado Nuevos / Novos decorados *	1.154 €	1.207 €	1.267 €	1.320 €
ENTRADA MÍNIMA mm / ENTRADA MÍNIMO mm		392	442	542	692

\* Para serigrafías digitales confirmar precio con ATC. / Para serigrafias digitais confirmar preço com ATC.

### VIDRIO Y DECORADO VIDRO E DECORADO

TRANSP.



SIN DECORADO



PICTOR

AFFUMICATO



SIN DECORADO



PICTOR

BRONCE



SIN DECORADO



PICTOR

MATE



SIN DECORADO

### NUEVOS DECORADOS NOVOS DECORADOS

SERIGRAFIAS ESPECIALES



MIRAI



WETLANDS



GRID

SERIGRAFIAS DIGITALES



BAMBOO



WAVE



FOG

# plus

**PC9** | MAMPARA DE DUCHA: 2 PUERTAS CORREDERAS Y 2 FIJOS MÁS LATERAL  
 DIVISÓRIA DE DUCHE: 2 PORTAS DE CORRER E 2 FIXOS MAIS LATERAL

**PB9** | MAMPARA DE BAÑERA: 2 PUERTAS CORREDERAS Y 2 FIJOS MAS LATERAL  
 DIVISÓRIA DE BANHEIRA: 2 PORTAS DE CORRER E 2 FIXOS MAIS LATERAL

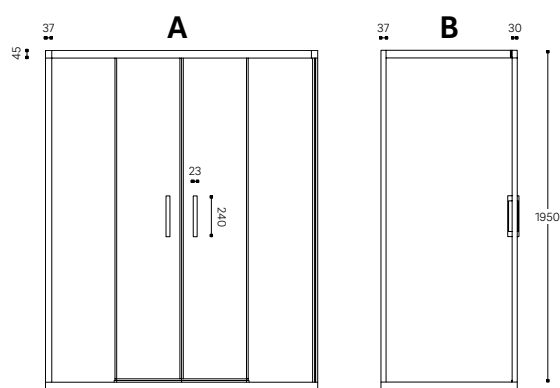

Dimensiones en mm.  
 Dimensões em mm.



VIDRIO TEMPLADO  
 VIDRO TEMPERADO  
**6 MM**



COMPENSACIÓN A CADA LADO  
 COMPENSAÇÃO A CADA LADO  
**15 MM**



ALTURA MODELO DUCHA  
 ALTURA MODELO DUCHE  
**1950 MM**



ALTURA MODELO BAÑERA  
 ALTURA DO MODELO BANHEIRA  
**1500 MM**



MEDIDAS Y ALTURAS ESPECIALES  
 MEDIDAS E ALTURAS ESPECIAIS  
 (VER PÁG. / CONSULTA A PÁG. **372**)



PUERTAS DESMONTABLES,  
**FÁCIL LIMPIEZA**  
 PORTAS REMOVÍVEIS,  
**FÁCIL LIMPEZA**



TRATAMIENTO OPCIONAL (M)  
 TRATAMENTO OPCIONAL (M)  
 FRONTAL **95 €** - LATERAL **35 €**



MONTAJE  
 MONTAJEM  
**130 € \***

\* Precio recomendado  
 Código montaje **CSM12**  
 Para desplazamientos  
 consultar pág. **373**

\* Preço recomendado  
 Código montagem **CSM12**  
 Para deslocações  
 consultar pág. **373**

## ACABADOS METÁLICOS ACABAMENTOS METÁLICOS



BLANCO  
 BRANCO



PLATA BRILLO  
 PRATA BRILHO



PLATA MATE  
 PRATA MATE

## PC9 | FRONTAL DUCHA FRONTAL DUCHE

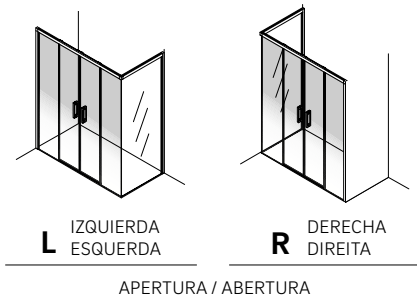

		A mm			
PERFIL BLANCO - PLATA BRILLO - PLATA MATE PERFIL BRANCO - PRATA BRILHO - PRATA MATE		1200-1300	1301-1500	1501-1800	1801-2000
VIDRIO VIDRO	Transparente	790 €	829 €	867 €	904 €
	Affumicato, Bronce, Mate, Transp. decorado	988 €	1.036 €	1.084 €	1.130 €
	Affumicato decorado Bronce decorado Nuevos / Novos decorados *	1.106 €	1.161 €	1.214 €	1.266 €
ENTRADA MÍNIMA mm / ENTRADA MÍNIMO mm		395	445	545	695

## PLS | LATERAL DUCHA LATERAL DUCHE

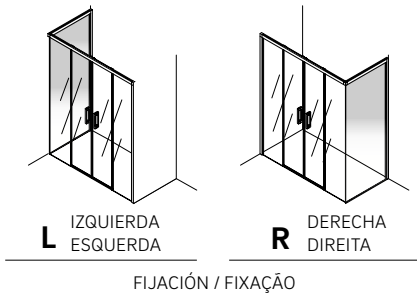

		B mm			
PERFIL BLANCO - PLATA BRILLO - PLATA MATE PERFIL BRANCO - PRATA BRILHO - PRATA MATE		200-400	401-600	601-800	801-1000
VIDRIO VIDRO	Transparente	216 €	246 €	278 €	307 €
	Affumicato, Bronce, Mate, Transp. decorado	270 €	308 €	348 €	384 €
	Affumicato decorado Bronce decorado Nuevos / Novos decorados *	302 €	344 €	389 €	430 €

## PB9 | FRONTAL BAÑERA FRONTAL BANHEIRA

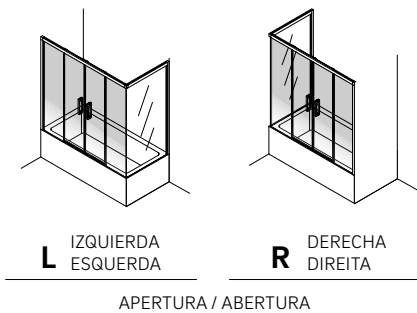

		A mm			
PERFIL BLANCO - PLATA BRILLO - PLATA MATE PERFIL BRANCO - PRATA BRILHO - PRATA MATE		1200-1300	1301-1500	1501-1800	1801-2000
VIDRIO VIDRO	Transparente	824 €	862 €	905 €	943 €
	Mate, Transp. decorado	1.030 €	1.078 €	1.131 €	1.179 €
	Affumicato decorado	1.154 €	1.207 €	1.267 €	1.320 €
ENTRADA MÍNIMA mm / ENTRADA MÍNIMO mm		395	445	545	695

## PLZ | LATERAL BAÑERA LATERAL BANHEIRA

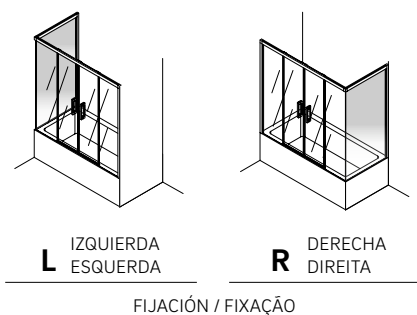

		B mm			
PERFIL BLANCO - PLATA BRILLO - PLATA MATE PERFIL BRANCO - PRATA BRILHO - PRATA MATE		200-400	401-600	601-800	801-1000
VIDRIO VIDRO	Transparente	192 €	223 €	254 €	283 €
	Affumicato, Mate, Transp. decorado	240 €	279 €	318 €	354 €
	Affumicato decorado	269 €	312 €	356 €	396 €

\* Para serigrafías digitales confirmar precio con ATC. / Para serigrafias digitais confirmar preço com ATC.

### VIDRIO Y DECORADO VIDRO E DECORADO



### NUEVOS DECORADOS NOVOS DECORADOS



PC5 | MAMPARA ANGULAR: 2 PUERTAS CORREDERAS Y 2 FIJOS  
 DIVISÓRIA ANGULAR: 2 PORTAS DE CORRER E 2 FIXOS

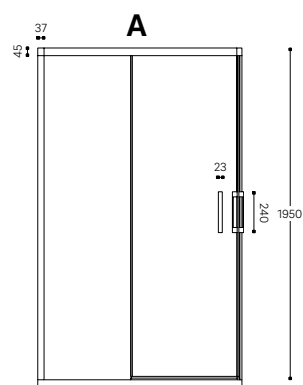

Dimensiones en mm.  
 Dimensões em mm.



VIDRIO TEMPLADO  
 VIDRO TEMPERADO  
**6 MM**



COMPENSACIÓN A CADA LADO  
 COMPENSAÇÃO A CADA LADO  
**15 MM**



ALTURA ESTÁNDAR  
 ALTURA NORMA  
**1950 MM**



REVERSIBLE  
 REVERSÍVEL



MEDIDAS Y ALTURAS ESPECIALES  
 MEDIDAS E ALTURAS ESPECIAIS  
 (VER PÁG. / CONSULTA A PÁG. **372**)



PUERTAS DESMONTABLES,  
**FÁCIL LIMPIEZA**  
 PORTAS REMOVÍVEIS,  
**FÁCIL LIMPEZA**



TRATAMIENTO OPCIONAL (M)  
 TRATAMENTO OPCIONAL (M)  
**47,50 €**



MONTAJE  
 MONTAJEM  
**125 € \***

\* Precio recomendado  
 Código montaje **CSM11**  
 Para desplazamientos  
 consultar pág. **373**

\* Preço recomendado  
 Código montagem **CSM11**  
 Para deslocações  
 consultar pág. **373**

## ACABADOS METÁLICOS ACABAMENTOS METÁLICOS



BLANCO  
 BRANCO



PLATA BRILLO  
 PRATA BRILHO



PLATA MATE  
 PRATA MATE



# PC5 | FRONTAL

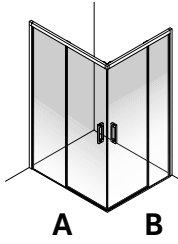

PERFIL BLANCO - PLATA BRILLO - PLATA MATE MISMO PRECIO  
 PERFIL BRANCO - PRATA BRILHO - PRATA MATE MESMO PREÇO

		A mm			
		650-750	751-1000	1001-1200	1201-1400
VIDRIO VIDRO	Transparente	474 €	512 €	549 €	586 €
	Affumicato, Bronce, Mate, Transp. decorado	593 €	640 €	686 €	733 €
	Affumicato decorado Bronce decorado Nuevos / Novos decorados *	664 €	717 €	769 €	820 €
ENTRADA MÍNIMA mm / ENTRADA MÍNIMO mm		295	330	435	525

		B mm			
		650-750	751-1000	1001-1200	1201-1400
VIDRIO VIDRO	Transparente	474 €	512 €	549 €	586 €
	Affumicato, Bronce, Mate, Transp. decorado	593 €	640 €	686 €	733 €
	Affumicato decorado Bronce decorado Nuevos / Novos decorados *	664 €	717 €	769 €	820 €
ENTRADA MÍNIMA mm / ENTRADA MÍNIMO mm		295	330	435	525

Para precio total, sumar ambos lados A y B.  
 Para o preço total, some os dois lados A e B.

\* Para serigrafías digitales confirmar precio con ATC. / Para serigrafias digitais confirmar preço com ATC.

## VIDRIO Y DECORADO VIDRO E DECORADO



## NUEVOS DECORADOS NOVOS DECORADOS



Stock

Info

PCC | MAMPARA CUARTOCIRCULAR: 2 PUERTAS CORREDERAS Y 2 SEGMENTOS FIJOS  
 DIVISÓRIA QUARTO-CIRCULAR: 2 PORTAS DE CORRER E 2 FIXOS

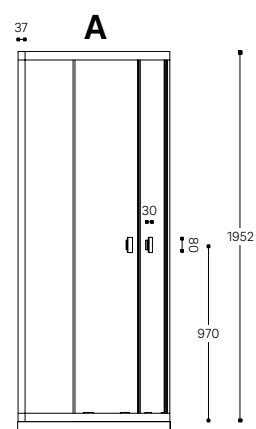

Dimensiones en mm.  
 Dimensões em mm.



VIDRIO TEMPLADO  
 VIDRO TEMPERADO  
**6 MM**



COMPENSACIÓN A CADA LADO  
 COMPENSAÇÃO A CADA LADO  
**15 MM**



REVERSIBLE  
 REVERSÍVEL



ALTURA MODELO DUCHA  
 ALTURA MODELO DUCHE  
**1950 MM**  
 NO SE FABRICA A OTRAS ALTURAS  
 NÃO FABRICA EM OUTRAS ALTURAS



MEDIDAS ESPECIALES  
 MEDIDAS ESPECIAIS  
 (VER PÁG. / CONSULTA A PÁG. **372**)



PUERTAS DESMONTABLES,  
**FÁCIL LIMPIEZA**  
 PORTAS REMOVÍVEIS,  
**FÁCIL LIMPEZA**



TRATAMIENTO OPCIONAL (M)  
 TRATAMENTO OPCIONAL (M)  
**47,50 €**



MONTAJE  
 MONTAJEM  
**125 € \***

\* Precio recomendado  
 Código montaje **CSM11**  
 Para desplazamientos  
 consultar pág. **373**

\* Preço recomendado  
 Código montagem **CSM11**  
 Para deslocações  
 consultar pág. **373**

## ACABADOS METÁLICOS ACABAMENTOS METÁLICOS



BLANCO  
 BRANCO



PLATA BRILLO  
 PRATA BRILHO



PLATA MATE  
 PRATA MATE

# PCC | RADIO RAIO 500

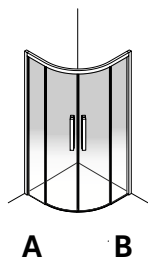

Para precio total, sumar ambos lados A y B.  
 Para o preço total, some os dois lados A e B.

PERFIL BLANCO - PLATA BRILLO - PLATA MATE MISMO PRECIO  
 PERFIL BRANCO - PRATA BRILHO - PRATA MATE MESMO PREÇO

		A mm	
		725-900	901-1000
VIDRIO VIDRO	Transparente	609 €	658 €
	Affumicato, Mate, Transp. decorado	761 €	823 €
ENTRADA MÍNIMA mm / ENTRADA MÍNIMO mm		475	475

		B mm	
		725-900	901-1000
VIDRIO VIDRO	Transparente	609 €	658 €
	Affumicato, Mate, Transp. decorado	761 €	823 €
ENTRADA MÍNIMA mm / ENTRADA MÍNIMO mm		475	475

## VIDRIO Y DECORADO VIDRO E DECORADO

TRANSP.



SIN DECORADO



PICTOR

MATE



SIN DECORADO

Stock

Info

# technic

- TC2** | MAMPARA DE DUCHA: 1 PUERTA CORREDERA Y 1 FIJO ENTRE PAREDES  
 DIVISÓRIA DE DUCHE: 1 PORTA DE CORRER E 1 FIXO ENTRE PAREDE
- TB2** | MAMPARA DE BAÑERA: 1 PUERTA CORREDERA Y 1 FIJO ENTRE PAREDES  
 DIVISÓRIA DE BANHEIRA: 1 PORTA DE CORRER E 1 FIXO ENTRE PAREDE

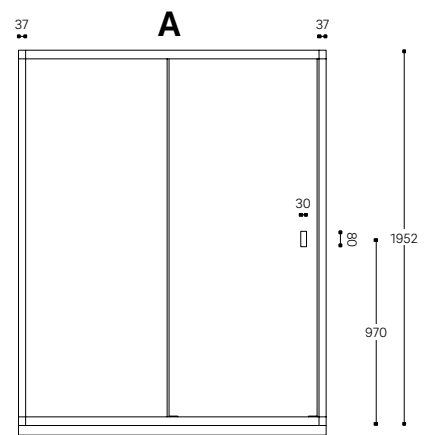

Dimensiones en mm.  
 Dimensões em mm.



VIDRIO TEMPLADO  
 VIDRO TEMPERADO  
**6 MM**



COMPENSACIÓN A CADA LADO  
 COMPENSAÇÃO A CADA LADO  
**15 MM**



ALTURA MODELO DUCHA  
 ALTURA MODELO DUCHE  
**1950 MM**



ALTURA MODELO BAÑERA  
 ALTURA DO MODELO BANHEIRA  
**1500 MM**



MEDIDAS Y ALTURAS ESPECIALES  
 MEDIDAS E ALTURAS ESPECIAIS  
 (VER PÁG. / CONSULTA A PÁG. **372**)



PUERTAS DESMONTABLES,  
**FÁCIL LIMPIEZA**  
 PORTAS REMOVÍVEIS,  
**FÁCIL LIMPEZA**



TRATAMIENTO OPCIONAL (M)  
 TRATAMENTO OPCIONAL (M)  
**65 €**



MONTAJE  
 MONTAJEM  
**95 € \***

\* Preço recomendado  
 Código montaje **CSM05**  
 Para desplazamientos  
 consultar pág. **373**

\* Preço recomendado  
 Código montagem **CSM05**  
 Para deslocações  
 consultar pág. **373**

## ACABADOS METÁLICOS ACABAMENTOS METÁLICOS



BLANCO  
 BRANCO



PLATA BRILLO  
 PRATA BRILHO



PLATA MATE  
 PRATA MATE

## TC2 | DUCHA DUCHE

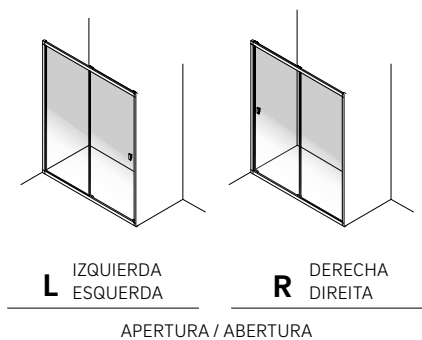

		A mm			
PERFIL BLANCO - PLATA BRILLO - PLATA MATE PERFIL BRANCO - PRATA BRILHO - PRATA MATE		1000-1100	1101-1300	1301-1600	1601-2000
VIDRIO VIDRO	Transparente	728 €	776 €	826 €	875 €
	Affumicato, Bronce, Mate, Transp. decorado	910 €	970 €	1.033 €	1.094 €
	Affumicato decorado Bronce decorado Nuevos / Novos decorados *	1.019 €	1.086 €	1.156 €	1.225 €
ENTRADA MÍNIMA mm / ENTRADA MÍNIMO mm		397	448	548	698

## TB2 | BAÑERA BANHEIRA

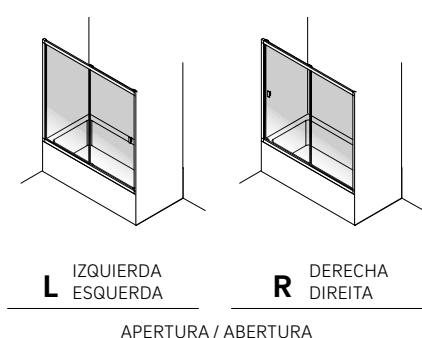

		A mm			
PERFIL BLANCO - PLATA BRILLO - PLATA MATE PERFIL BRANCO - PRATA BRILHO - PRATA MATE		1000-1100	1101-1300	1301-1600	1601-2000
VIDRIO VIDRO	Transparente	666 €	700 €	743 €	785 €
	Affumicato, Bronce, Mate, Transp. decorado	833 €	875 €	929 €	981 €
	Affumicato decorado Bronce decorado Nuevos / Novos decorados *	932 €	980 €	1.040 €	1.099 €
ENTRADA MÍNIMA mm / ENTRADA MÍNIMO mm		397	448	548	698

\* Para serigrafías digitales confirmar precio con ATC. / Para serigrafias digitais confirmar preço com ATC.

### VIDRIO Y DECORADO VIDRO E DECORADO



### NUEVOS DECORADOS NOVOS DECORADOS



# technic

- TC7 | MAMPARA DE DUCHA: 1 PUERTA CORREDERA Y 1 FIJO MÁS LATERAL  
 DIVISÓRIA DE DUCHE: 1 PORTA DE CORRER E 1 FIXO MAIS LATERAL
- TB7 | MAMPARA DE BAÑERA: 1 PUERTA CORREDERA Y 1 FIJO MÁS LATERAL  
 DIVISÓRIA DE BANHEIRA: 1 PORTA DE CORRER E 1 FIXO MAIS LATERAL

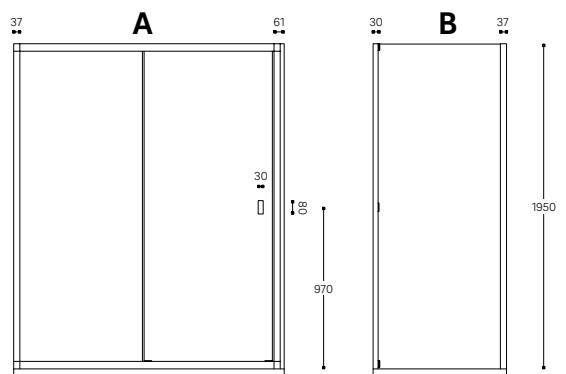

Dimensiones en mm.  
 Dimensões em mm.



VIDRIO TEMPLADO  
 VIDRO TEMPERADO  
**6 MM**



COMPENSACIÓN A CADA LADO  
 EN FRONTAL Y LATERAL  
 COMPENSAÇÃO A CADA LADO  
 EM FRONTAL E LATERAL  
**15 MM**



ALTURA MODELO DUCHA  
 ALTURA MODELO DUCHE  
**1950 MM**



ALTURA MODELO BAÑERA  
 ALTURA DO MODELO BANHEIRA  
**1500 MM**



MEDIDAS Y ALTURAS ESPECIALES  
 MEDIDAS E ALTURAS ESPECIAIS  
 (VER PÁG. / CONSULTA A PÁG. **372**)



PUERTAS DESMONTABLES,  
**FÁCIL LIMPIEZA**  
 PORTAS REMOVÍVEIS,  
**FÁCIL LIMPEZA**



TRATAMIENTO OPCIONAL (M)  
 TRATAMENTO OPCIONAL (M)  
 FRONTAL **65 €** - LATERAL **35 €**



LATERAL REVERSIBLE  
 LATERAL REVERSÍVEL



MONTAJE  
 MONTAJEM  
**120 € \***

\* Precio recomendado  
 Código montaje **CSM10**  
 Para desplazamientos  
 consultar pág. **373**

\* Preço recomendado  
 Código montagem **CSM10**  
 Para deslocações  
 consultar pág. **373**

## ACABADOS METÁLICOS ACABAMENTOS METÁLICOS



BLANCO  
 BRANCO



PLATA BRILLO  
 PRATA BRILHO



PLATA MATE  
 PRATA MATE

## TC7 | FRONTAL DUCHA FRONTAL DUCHE

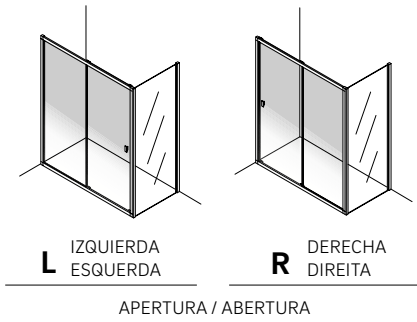

		A mm			
PERFIL BLANCO - PLATA BRILLO - PLATA MATE PERFIL BRANCO - PRATA BRILHO - PRATA MATE		1000-1100	1101-1300	1301-1600	1601-2000
VIDRIO VIDRO	Transparente	728 €	776 €	826 €	875 €
	Affumicato, Bronce, Mate, Transp. decorado	910 €	970 €	1.033 €	1.094 €
	Affumicato decorado Bronce decorado Nuevos / Novos decorados *	1.019 €	1.086 €	1.156 €	1.225 €
ENTRADA MÍNIMA mm / ENTRADA MÍNIMO mm		385	436	536	686

## TLC | LATERAL DUCHA LATERAL DUCHE

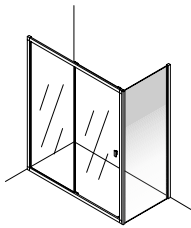

		B mm			
PERFIL BLANCO - PLATA BRILLO - PLATA MATE PERFIL BRANCO - PRATA BRILHO - PRATA MATE		200-400	401-600	601-800	801-1000
VIDRIO VIDRO	Transparente	260 €	283 €	313 €	341 €
	Affumicato, Bronce, Mate, Transp. decorado	325 €	354 €	391 €	426 €
	Affumicato decorado Bronce decorado Nuevos / Novos decorados *	364 €	396 €	438 €	477 €

## TB7 | FRONTAL BAÑERA FRONTAL BANHEIRA

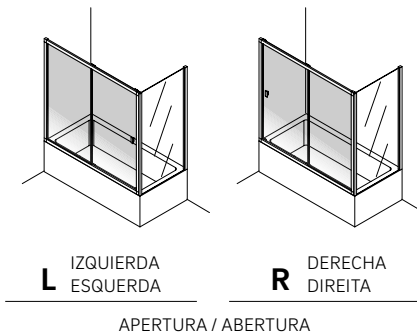

		A mm			
PERFIL BLANCO - PLATA BRILLO - PLATA MATE PERFIL BRANCO - PRATA BRILHO - PRATA MATE		1000-1100	1101-1300	1301-1600	1601-2000
VIDRIO VIDRO	Transparente	666 €	700 €	743 €	785 €
	Affumicato, Bronce, Mate, Transp. decorado	833 €	875 €	929 €	981 €
	Affumicato decorado Bronce decorado Nuevos / Novos decorados *	932 €	980 €	1.040 €	1.099 €
ENTRADA MÍNIMA mm / ENTRADA MÍNIMO mm		385	436	536	686

## TLG | LATERAL BAÑERA LATERAL BANHEIRA

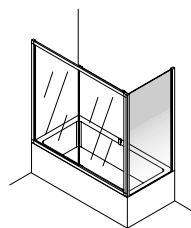

		B mm			
PERFIL BLANCO - PLATA BRILLO - PLATA MATE PERFIL BRANCO - PRATA BRILHO - PRATA MATE		200-400	401-600	601-800	801-1000
VIDRIO VIDRO	Transparente	226 €	249 €	278 €	306 €
	Affumicato, Bronce, Mate, Transp. decorado	283 €	311 €	348 €	383 €
	Affumicato decorado Bronce decorado Nuevos / Novos decorados *	316 €	349 €	389 €	428 €

\* Para serigrafías digitales confirmar precio con ATC. / Para serigrafias digitais confirmar preço com ATC.

### VIDRIO Y DECORADO VIDRO E DECORADO



### NUEVOS DECORADOS NOVOS DECORADOS



# technic

**TC3** | MAMPARA DE DUCHA: 2 PUERTAS CORREDERAS Y 1 FIJO ENTRE PAREDES  
 DIVISÓRIA DE DUCHE: 2 PORTAS DE CORRER E 1 FIXO ENTRE PAREDE

**TB3** | MAMPARA DE BAÑERA: 2 PUERTAS CORREDERAS Y 1 FIJO ENTRE PAREDES  
 DIVISÓRIA DE BANHEIRA: 2 PORTAS DE CORRER E 1 FIXO ENTRE PAREDE

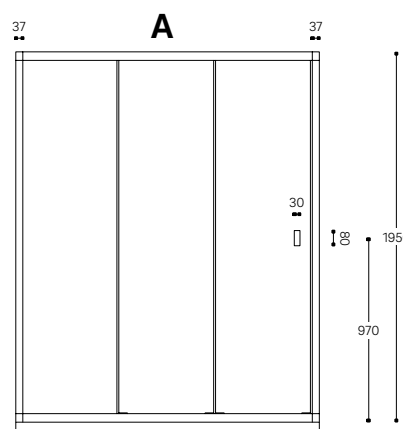

Dimensiones en mm.  
 Dimensões em mm.



VIDRIO TEMPLADO  
 VIDRO TEMPERADO  
**6 MM**



COMPENSACIÓN A CADA LADO  
 EN FRONTAL Y LATERAL  
 COMPENSAÇÃO A CADA LADO  
 EM FRONTAL E LATERAL  
**15 MM**



ALTURA MODELO DUCHA  
 ALTURA MODELO DUCHE  
**1950 MM**



ALTURA MODELO BAÑERA  
 ALTURA DO MODELO BANHEIRA  
**1500 MM**



MEDIDAS Y ALTURAS ESPECIALES  
 MEDIDAS E ALTURAS ESPECIAIS  
 (VER PÁG. / CONSULTA A PÁG. **372**)



PUERTAS DESMONTABLES,  
**FÁCIL LIMPIEZA**  
 PORTAS REMOVÍVEIS,  
**FÁCIL LIMPEZA**



TRATAMIENTO OPCIONAL (M)  
 TRATAMENTO OPCIONAL (M)  
**85 €**



MONTAJE  
 MONTAJEM  
**100 € \***

\* Precio recomendado  
 Código montaje **CSM06**  
 Para desplazamientos  
 consultar pág. **373**

\* Preço recomendado  
 Código montagem **CSM06**  
 Para deslocações  
 consultar pág. **373**

## ACABADOS METÁLICOS ACABAMENTOS METÁLICOS



BLANCO  
 BRANCO



PLATA BRILLO  
 PRATA BRILHO



PLATA MATE  
 PRATA MATE



## TC3 | DUCHA FRONTAL DUCHE FRONTAL

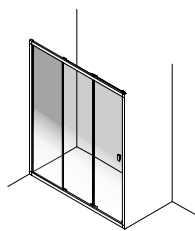

PERFIL BLANCO - PLATA BRILLO - PLATA MATE PERFIL BRANCO - PRATA BRILHO - PRATA MATE		A mm	
		1001-1300	1301-1600
VIDRIO VIDRO	Transparente	902 €	949 €
	Affumicato, Bronce, Mate, Transp. decorado	1.128 €	1.186 €
	Affumicato decorado Bronce decorado Nuevos / Novos decorados *	1.263 €	1.329 €
ENTRADA MÍNIMA mm / ENTRADA MÍNIMO mm		562	762

## TB3 | BAÑERA FRONTAL BANHEIRA FRONTAL

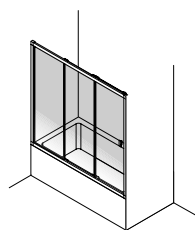

PERFIL BLANCO - PLATA BRILLO - PLATA MATE PERFIL BRANCO - PRATA BRILHO - PRATA MATE		A mm	
		1001-1300	1301-1600
VIDRIO VIDRO	Transparente	818 €	860 €
	Affumicato, Bronce, Mate, Transp. decorado	1.023 €	1.075 €
	Affumicato decorado Bronce decorado Nuevos / Novos decorados *	1.145 €	1.204 €
ENTRADA MÍNIMA mm / ENTRADA MÍNIMO mm		562	762

\* Para serigrafías digitales confirmar precio con ATC. / Para serigrafias digitais confirmar preço com ATC.

### VIDRIO Y DECORADO VIDRO E DECORADO

TRANSP.



SIN DECORADO



PICTOR

AFFUMICATO



SIN DECORADO



PICTOR

BRONCE



SIN DECORADO



PICTOR

MATE



SIN DECORADO

### NUEVOS DECORADOS NOVOS DECORADOS

SERIGRAFIAS ESPECIALES



MIRAI



WETLANDS



GRID

SERIGRAFIAS DIGITALES



BAMBOO



WAVE



FOG

# technic

**TC8** | MAMPARA DE DUCHA: 2 PUERTAS CORREDERAS Y 1 FIJO MÁS LATERAL  
 DIVISÓRIA DE DUCHE: 2 PORTAS DE CORRER E 1 FIXO MAIS LATERAL

**TB8** | MAMPARA DE BAÑERA: 2 PUERTAS CORREDERAS Y 1 FIJO MÁS LATERAL  
 DIVISÓRIA DE BANHEIRA: 2 PORTAS DE CORRER E 1 FIXO MAIS LATERAL

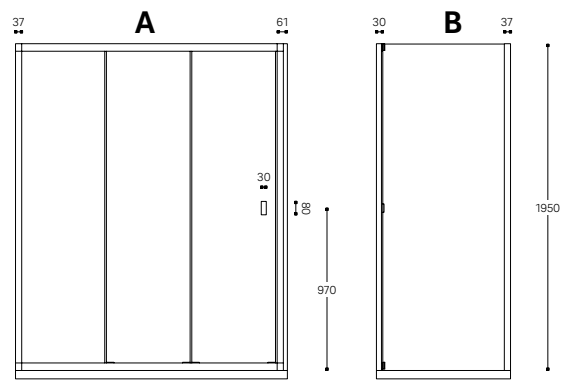

Dimensiones en mm.  
 Dimensões em mm.



VIDRIO TEMPLADO  
 VIDRO TEMPERADO  
**6 MM**



COMPENSACIÓN A CADA LADO  
 COMPENSAÇÃO A CADA LADO  
**15 MM**



ALTURA MODELO DUCHA  
 ALTURA MODELO DUCHE  
**1950 MM**



ALTURA MODELO BAÑERA  
 ALTURA DO MODELO BANHEIRA  
**1500 MM**



MEDIDAS Y ALTURAS ESPECIALES  
 MEDIDAS E ALTURAS ESPECIAIS  
 (VER PÁG. / CONSULTA A PÁG. **372**)



PUERTAS DESMONTABLES,  
**FÁCIL LIMPIEZA**  
 PORTAS REMOVÍVEIS,  
**FÁCIL LIMPEZA**



TRATAMIENTO OPCIONAL (M)  
 TRATAMENTO OPCIONAL (M)  
 FRONTAL **85 €** - LATERAL **35 €**



LATERAL REVERSIBLE  
 LATERAL REVERSÍVEL



MONTAJE  
 MONTAJEM  
**125 € \***

\* Precio recomendado  
 Código montaje **CSM11**  
 Para desplazamientos  
 consultar pág. **373**

\* Preço recomendado  
 Código montagem **CSM11**  
 Para deslocações  
 consultar pág. **373**

## ACABADOS METÁLICOS ACABAMENTOS METÁLICOS



BLANCO  
 BRANCO



PLATA BRILLO  
 PRATA BRILHO



PLATA MATE  
 PRATA MATE

## TC8 | DUCHA FRONTAL DUCHE FRONTAL

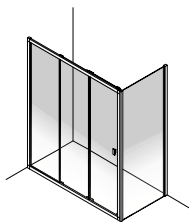

PERFIL BLANCO - PLATA BRILLO - PLATA MATE PERFIL BRANCO - PRATA BRILHO - PRATA MATE		A mm	
		1001-1300	1301-1600
VIDRIO VIDRO	Transparente	902 €	949 €
	Affumicato, Bronce, Mate, Transp. decorado	1.128 €	1.186 €
	Affumicato decorado Bronce decorado Nuevos / Novos decorados *	1.263 €	1.329 €
ENTRADA MÍNIMA mm / ENTRADA MÍNIMO mm		545	745

## TLC | DUCHA LATERAL DUCHE LATERAL

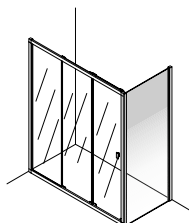

PERFIL BLANCO - PLATA BRILLO - PLATA MATE PERFIL BRANCO - PRATA BRILHO - PRATA MATE		B mm			
		200-400	401-600	601-800	801-1000
VIDRIO VIDRO	Transparente	260 €	283 €	313 €	341 €
	Affumicato, Bronce, Mate, Transp. decorado	325 €	354 €	391 €	426 €
	Affumicato decorado Bronce decorado Nuevos / Novos decorados *	364 €	396 €	438 €	477 €

## TB8 | BAÑERA FRONTAL BANHEIRA FRONTAL

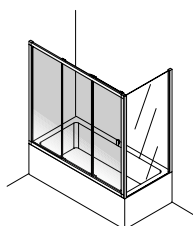

PERFIL BLANCO - PLATA BRILLO - PLATA MATE PERFIL BRANCO - PRATA BRILHO - PRATA MATE		A mm	
		1001-1300	1301-1600
VIDRIO VIDRO	Transparente	818 €	860 €
	Affumicato, Bronce, Mate, Transp. decorado	1.023 €	1.075 €
	Affumicato decorado Bronce decorado Nuevos / Novos decorados *	1.145 €	1.204 €
ENTRADA MÍNIMA mm / ENTRADA MÍNIMO mm		545	745

## TLG | BAÑERA LATERAL BANHEIRA LATERAL

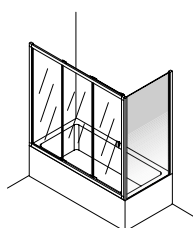

PERFIL BLANCO - PLATA BRILLO - PLATA MATE PERFIL BRANCO - PRATA BRILHO - PRATA MATE		B mm			
		200-400	401-600	601-800	801-1000
VIDRIO VIDRO	Transparente	226 €	249 €	278 €	306 €
	Affumicato, Bronce, Mate, Transp. decorado	283 €	311 €	348 €	383 €
	Affumicato decorado Bronce decorado Nuevos / Novos decorados *	316 €	349 €	389 €	428 €

\* Para serigrafías digitales confirmar precio con ATC. / Para serigrafias digitais confirmar preço com ATC.

### VIDRIO Y DECORADO VIDRO E DECORADO



### NUEVOS DECORADOS NOVOS DECORADOS



# technic

**TC4** | MAMPARA DE DUCHA: 2 PUERTAS CORREDERAS Y 2 FIJOS ENTRE PAREDES  
 DIVISÓRIA DE DUCHE: 2 PORTAS DE CORRER E 2 FIXOS ENTRE PAREDE

**TB4** | MAMPARA BAÑERA: 2 PUERTAS CORREDERAS Y 2 FIJOS ENTRE PAREDES  
 DIVISÓRIA DE BANHEIRA: 2 PORTAS DE CORRER E 1 FIXOS ENTRE PAREDE

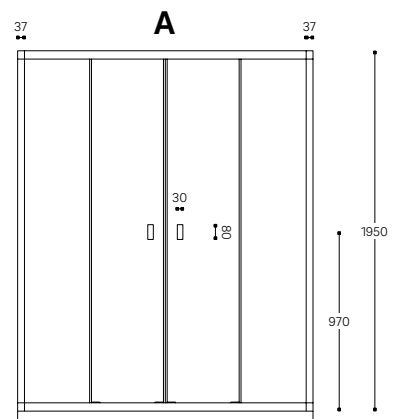

Dimensiones en mm.  
 Dimensões em mm.



VIDRIO TEMPLADO  
 VIDRO TEMPERADO  
**6 MM**



COMPENSACIÓN A CADA LADO  
 COMPENSAÇÃO A CADA LADO  
**15 MM**



ALTURA MODELO DUCHA  
 ALTURA MODELO DUCHE  
**1950 MM**



ALTURA MODELO BAÑERA  
 ALTURA DO MODELO BANHEIRA  
**1500 MM**



MEDIDAS Y ALTURAS ESPECIALES  
 MEDIDAS E ALTURAS ESPECIAIS  
 (VER PÁG. / CONSULTA A PÁG. **372**)



PUERTAS DESMONTABLES,  
**FÁCIL LIMPIEZA**  
 PORTAS REMOVÍVEIS,  
**FÁCIL LIMPEZA**



TRATAMIENTO OPCIONAL (M)  
 TRATAMENTO OPCIONAL (M)  
**35 €**



REVERSIBLE  
 REVERSÍVEL



MONTAJE  
 MONTAJEM  
**105 € \***

\* Precio recomendado  
 Código montaje **CSM07**  
 Para desplazamientos  
 consultar pág. **373**

\* Preço recomendado  
 Código montagem **CSM07**  
 Para deslocações  
 consultar pág. **373**

## ACABADOS METÁLICOS ACABAMENTOS METÁLICOS



BLANCO  
 BRANCO



PLATA BRILLO  
 PRATA BRILHO



PLATA MATE  
 PRATA MATE

## TC4 | DUCHA FRONTAL DUCHE FRONTAL

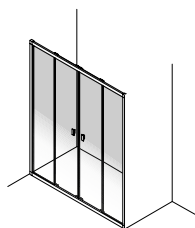

		A mm			
PERFIL BLANCO - PLATA BRILLO - PLATA MATE PERFIL BRANCO - PRATA BRILHO - PRATA MATE		1200-1300	1301-1500	1501-1800	1801-2000
VIDRIO VIDRO	Transparente	971 €	1.020 €	1.068 €	1.116 €
	Affumicato, Bronce, Mate, Transp. decorado	1.214 €	1.275 €	1.335 €	1.395 €
	Affumicato decorado Bronce decorado Nuevos / Novos decorados *	1.359 €	1.428 €	1.495 €	1.562 €
ENTRADA MÍNIMA mm / ENTRADA MÍNIMO mm		462	513	613	763

## TB4 | BAÑERA FRONTAL BANHEIRA FRONTAL

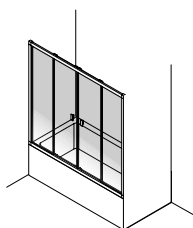

		A mm			
PERFIL BLANCO - PLATA BRILLO - PLATA MATE PERFIL BRANCO - PRATA BRILHO - PRATA MATE		1200-1300	1301-1500	1501-1800	1801-2000
VIDRIO VIDRO	Transparente	894 €	936 €	977 €	1.020 €
	Affumicato, Bronce, Mate, Transp. decorado	1.118 €	1.170 €	1.221 €	1.275 €
	Affumicato decorado Bronce decorado Nuevos / Novos decorados *	1.252 €	1.310 €	1.368 €	1.428 €
ENTRADA MÍNIMA mm / ENTRADA MÍNIMO mm		462	513	613	763

\* Para serigrafías digitales confirmar precio con ATC. / Para serigrafias digitais confirmar preço com ATC.

### VIDRIO Y DECORADO VIDRO E DECORADO

TRANSP.



SIN DECORADO



PICTOR

AFFUMICATO



SIN DECORADO



PICTOR

BRONCE



SIN DECORADO



PICTOR

MATE



SIN DECORADO

### NUEVOS DECORADOS NOVOS DECORADOS

SERIGRAFIAS ESPECIALES



MIRAI



WETLANDS



GRID

SERIGRAFIAS DIGITALES



BAMBOO



WAVE



FOG

# technic

TC9 | MAMPARA DE DUCHA: 2 PUERTAS CORREDERAS Y 2 FIJOS MÁS LATERAL  
 DIVISÓRIA DE DUCHE: 2 PORTAS DE CORRER E 2 FIXOS MAIS LATERAL

TB9 | MAMPARA DE BAÑERA: 2 PUERTAS CORREDERAS Y 2 FIJOS MÁS LATERAL  
 DIVISÓRIA DE BANHEIRA: 2 PORTAS DE CORRER E 2 FIXOS MAIS LATERAL

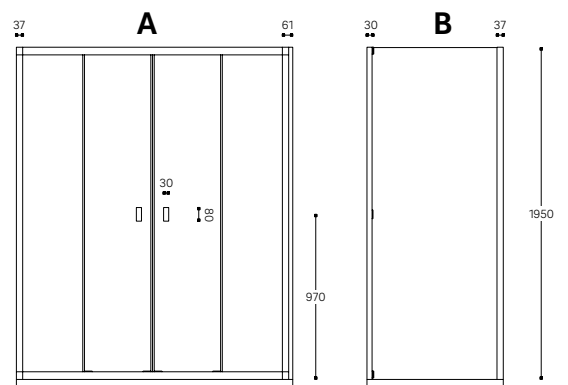

Dimensiones en mm.  
 Dimensões em mm.



VIDRIO TEMPLADO  
 VIDRO TEMPERADO  
**6 MM**



COMPENSACIÓN A CADA LADO  
 EN FRONTAL Y LATERAL  
 COMPENSAÇÃO A CADA LADO  
 EM FRONTAL E LATERAL  
**15 MM**



ALTURA MODELO DUCHA  
 ALTURA MODELO DUCHE  
**1950 MM**



ALTURA MODELO BAÑERA  
 ALTURA DO MODELO BANHEIRA  
**1500 MM**



MEDIDAS Y ALTURAS ESPECIALES  
 MEDIDAS E ALTURAS ESPECIAIS  
 (VER PÁG. / CONSULTA A PÁG. **372**)



PUERTAS DESMONTABLES,  
**FÁCIL LIMPIEZA**  
 PORTAS REMOVÍVEIS,  
**FÁCIL LIMPEZA**



TRATAMIENTO OPCIONAL (M)  
 TRATAMENTO OPCIONAL (M)  
 FRONTAL **95 €** - LATERAL **35 €**



REVERSIBLE  
 REVERSÍVEL



MONTAJE  
 MONTAJEM  
**130 € \***

\* Precio recomendado  
 Código montaje **CSM12**  
 Para desplazamientos  
 consultar pág. **373**

\* Preço recomendado  
 Código montagem **CSM12**  
 Para deslocações  
 consultar pág. **373**

## ACABADOS METÁLICOS ACABAMENTOS METÁLICOS



BLANCO  
 BRANCO



PLATA BRILLO  
 PRATA BRILHO



PLATA MATE  
 PRATA MATE

## TC9 | DUCHA FRONTAL DUCHE FRONTAL

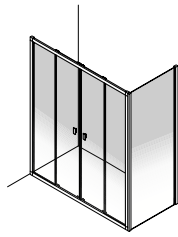

		A mm			
PERFIL BLANCO - PLATA BRILLO - PLATA MATE PERFIL BRANCO - PRATA BRILHO - PRATA MATE		1200-1300	1301-1500	1501-1800	1801-2000
VIDRIO VIDRO	Transparente	971 €	1.020 €	1.068 €	1.116 €
	Affumicato, Bronce, Mate, Transp. decorado	1.214 €	1.275 €	1.335 €	1.395 €
	Affumicato decorado Bronce decorado Nuevos / Novos decorados *	1.359 €	1.428 €	1.495 €	1.562 €
ENTRADA MÍNIMA mm / ENTRADA MÍNIMO mm		450	500	600	750

## TLC | DUCHA LATERAL DUCHE LATERAL

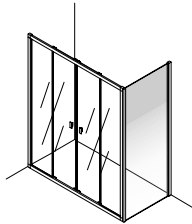

		B mm			
PERFIL BLANCO - PLATA BRILLO - PLATA MATE PERFIL BRANCO - PRATA BRILHO - PRATA MATE		200-400	401-600	601-800	801-1000
VIDRIO VIDRO	Transparente	260 €	283 €	313 €	341 €
	Affumicato, Bronce, Mate, Transp. decorado	325 €	354 €	391 €	426 €
	Affumicato decorado Bronce decorado Nuevos / Novos decorados *	364 €	396 €	438 €	477 €

## TB9 | BAÑERA FRONTAL BANHEIRA FRONTAL

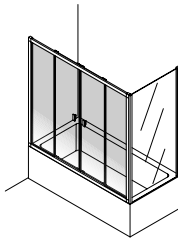

		A mm			
PERFIL BLANCO - PLATA BRILLO - PLATA MATE PERFIL BRANCO - PRATA BRILHO - PRATA MATE		1200-1300	1301-1500	1501-1800	1801-2000
VIDRIO VIDRO	Transparente	894 €	936 €	977 €	1.020 €
	Affumicato, Bronce, Mate, Transp. decorado	1.118 €	1.170 €	1.221 €	1.275 €
	Affumicato decorado Bronce decorado Nuevos / Novos decorados *	1.252 €	1.310 €	1.368 €	1.428 €
ENTRADA MÍNIMA mm / ENTRADA MÍNIMO mm		450	500	600	750

## TLG | BAÑERA LATERAL BANHEIRA LATERAL

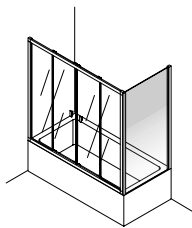

		B mm			
PERFIL BLANCO - PLATA BRILLO - PLATA MATE PERFIL BRANCO - PRATA BRILHO - PRATA MATE		200-400	401-600	601-800	801-1000
VIDRIO VIDRO	Transparente	226 €	249 €	278 €	306 €
	Affumicato, Bronce, Mate, Transp. decorado	283 €	311 €	348 €	383 €
	Affumicato decorado Bronce decorado Nuevos / Novos decorados *	316 €	349 €	389 €	428 €

\* Para serigrafías digitales confirmar precio con ATC. / Para serigrafías digitais confirmar preço com ATC.

### VIDRIO Y DECORADO VIDRO E DECORADO



### NUEVOS DECORADOS NOVOS DECORADOS



# technic

TC5 | MAMPARA ANGULAR: 2 PUERTAS CORREDERAS Y 2 FIJOS  
 DIVISÓRIA ANGULAR: 2 PORTAS DE CORRER E 2 FIXOS

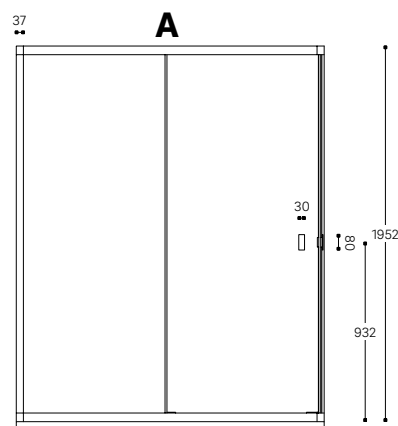

Dimensiones en mm.  
 Dimensões em mm.



VIDRIO TEMPLADO  
 VIDRO TEMPERADO  
**6 MM**



COMPENSACIÓN A CADA LADO  
 COMPENSAÇÃO A CADA LADO  
**15 MM**



ALTURA MODELO DUCHA  
 ALTURA MODELO DUCHE  
**1950 MM**



REVERSIBLE  
 REVERSÍVEL



MEDIDAS Y ALTURAS ESPECIALES  
 MEDIDAS E ALTURAS ESPECIAIS  
 (VER PÁG. / CONSULTA A PÁG. **372**)



PUERTAS DESMONTABLES,  
**FÁCIL LIMPIEZA**  
 PORTAS REMOVÍVEIS,  
**FÁCIL LIMPEZA**



TRATAMIENTO OPCIONAL (M)  
 TRATAMENTO OPCIONAL (M)  
**47,50 €**



MONTAJE  
 MONTAJEM  
**125 € \***

\* Precio recomendado  
 Código montaje **CSM11**  
 Para desplazamientos  
 consultar pág. **373**

\* Preço recomendado  
 Código montagem **CSM11**  
 Para deslocações  
 consultar pág. **373**

## ACABADOS METÁLICOS ACABAMENTOS METÁLICOS



BLANCO  
 BRANCO



PLATA BRILLO  
 PRATA BRILHO



PLATA MATE  
 PRATA MATE



# TC5 | ANGULAR

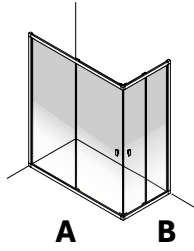

PERFIL BLANCO - PLATA BRILLO - PLATA MATE MISMO PRECIO  
 PERFIL BRANCO - PRATA BRILHO - PRATA MATE MESMO PREÇO

		A mm			
		650-750	751-1000	1001-1200	1201-1400
VIDRIO VIDRO	Transparente	493 €	534 €	576 €	617 €
	Affumicato, Bronce, Mate, Transp. decorado	616 €	668 €	720 €	771 €
	Affumicato decorado Bronce decorado Nuevos / Novos decorados *	690 €	748 €	806 €	864 €
ENTRADA MÍNIMA mm / ENTRADA MÍNIMO mm		319	356	460	549

		B mm			
		650-750	751-1000	1001-1200	1201-1400
VIDRIO VIDRO	Transparente	493 €	534 €	576 €	617 €
	Affumicato, Bronce, Mate, Transp. decorado	616 €	668 €	720 €	771 €
	Affumicato decorado Bronce decorado Nuevos / Novos decorados *	690 €	748 €	806 €	864 €
ENTRADA MÍNIMA mm / ENTRADA MÍNIMO mm		319	356	460	549

Para precio total, sumar ambos lados A y B.  
 Para o preço total, some os dois lados A e B.

\* Para serigrafías digitales confirmar precio con ATC. / Para serigrafías digitais confirmar preço com ATC.

## VIDRIO Y DECORADO VIDRO E DECORADO



## NUEVOS DECORADOS NOVOS DECORADOS



Stock

Info

# technic

TCC · TCX

MAMPARA CUARTOCIRCULAR: 2 PUERTAS CORREDERAS Y 2 FIJOS  
 DIVISÓRIA QUARTO-CIRCULAR: 2 PORTAS DE CORRER E 2 FIXOS

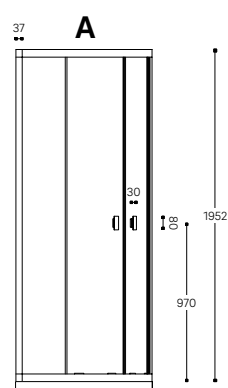

Dimensiones en mm.  
 Dimensões em mm.



VIDRIO TEMPLADO  
 VIDRO TEMPERADO  
**6 MM**



COMPENSACIÓN A CADA LADO  
 COMPENSAÇÃO A CADA LADO  
**15 MM**



REVERSIBLE  
 REVERSÍVEL



ALTURA MODELO DUCHA  
 ALTURA MODELO DUCHE  
**1950 MM**  
 NO SE FABRICA A OTRAS ALTURAS  
 NÃO FABRICA EM OUTRAS ALTURAS



MEDIDAS Y ALTURAS ESPECIALES  
 MEDIDAS E ALTURAS ESPECIAIS  
 (VER PÁG. / CONSULTA A PÁG. **372**)



PUERTAS DESMONTABLES,  
**FÁCIL LIMPIEZA**  
 PORTAS REMOVÍVEIS,  
**FÁCIL LIMPEZA**



TRATAMIENTO OPCIONAL (M)  
 TRATAMENTO OPCIONAL (M)  
**47,50 €**



MONTAJE  
 MONTAJEM  
**125 € \***

\* Precio recomendado  
 Código montaje **CSM11**  
 Para desplazamientos  
 consultar pág. **373**

\* Preço recomendado  
 Código montagem **CSM11**  
 Para deslocações  
 consultar pág. **373**

## ACABADOS METÁLICOS ACABAMENTOS METÁLICOS



BLANCO  
 BRANCO



PLATA BRILLO  
 PRATA BRILHO



PLATA MATE  
 PRATA MATE

## TCC | RADIO RAIO 500

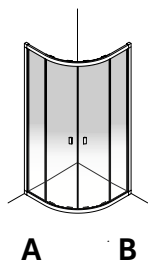

PERFIL BLANCO - PLATA BRILLO - PLATA MATE MISMO PRECIO  
 PERFIL BRANCO - PRATA BRILHO - PRATA MATE MESMO PREÇO

		<b>A<sub>mm</sub></b>	
		750-900	901-1100
VIDRIO VIDRO	Transparente	665 €	707 €
	Mate, Transp. decorado	831 €	884 €
ENTRADA MÍNIMA mm / ENTRADA MÍNIMO mm		475	475

		<b>B<sub>mm</sub></b>	
		750-900	901-1100
VIDRIO VIDRO	Transparente	665 €	707 €
	Mate, Transp. decorado	831 €	884 €
ENTRADA MÍNIMA mm / ENTRADA MÍNIMO mm		475	475

Para precio total, sumar ambos lados A y B.  
 Para o preço total, some os dois lados A e B.

## TCX | RADIO RAIO 550

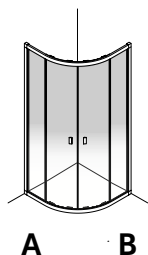

PERFIL BLANCO - PLATA BRILLO - PLATA MATE MISMO PRECIO  
 PERFIL BRANCO - PRATA BRILHO - PRATA MATE MESMO PREÇO

		<b>A<sub>mm</sub></b>	
		750-900	901-1100
VIDRIO VIDRO	Transparente	665 €	707 €
	Mate, Transp. decorado	831 €	884 €
ENTRADA MÍNIMA mm / ENTRADA MÍNIMO mm		420	420

		<b>B<sub>mm</sub></b>	
		750-900	901-1100
VIDRIO VIDRO	Transparente	665 €	707 €
	Mate, Transp. decorado	831 €	884 €
ENTRADA MÍNIMA mm / ENTRADA MÍNIMO mm		420	420

Para precio total, sumar ambos lados A y B.  
 Para o preço total, some os dois lados A e B.

### VIDRIO Y DECORADO VIDRO E DECORADO

TRANSP.



SIN DECORADO



PICTOR

MATE



SIN DECORADO

Stock

Info



# Batientes

Portas de abrir





Tirador de líneas rectas y cromado de alta calidad, que ha superado 200 horas de niebla salina como prueba para comprobar su resistencia al óxido. Disponible en cuatro medidas (40, 50, 60 y 70 cm), en los tres acabados (plata brillo, inox mate y negro mate).

---

Puxador de linhas retas e cromado de elevada qualidade, que superou 200 horas de névoa salina como prova para comprovar a sua resistência ao óxido. Disponível em quatro medidas (40, 50, 60 e 70) nos três acabamentos (prata brilho, inox mate e negro mate).









Bisagras, con apertura 180°,  
y escuadras cromadas y negras de alta calidad con tapa.

Dobradiças, com abertura 180°,  
e esquadrias cromadas e pretas de alta qualidade com tampa..









Nuevo acabado inox para un mampara de altas prestaciones.

Novo acabamento inox para uma divisória de alto desempenho.











Vidrios templados de 6 mm, disponibles en tono affumicato.  
Bisagra con apertura a 90 grados, con cromado de alta calidad  
resistente a la humedad. Anticorrosión.

Vidros temperados de 6 mm, disponíveis em tom affumicato  
Dobradiça de abertura a 90°, com cromado de alta qualidade  
resistente à humidade. Anticorrosão.









Los sistemas divisorios se someten a un test de 20.000 ciclos de apertura y cierre que garantiza su perfecta funcionalidad.

As nossas divisórias submetem-se a um teste de 20.000 ciclos de abertura e fecho que garante a sua perfeita funcionalidade.











Modelos plegables con bisagras cromadas.

Modelos de portas de abrir deslizantes com dobradiças cromadas.









Puertas con apertura a 180 grados.

Portas com abertura a 180°.







|  |  |  |  |  |  |  |  |  |  |  |  |  |  |  |  |  |  |  |  |  |  |  |  |  |  |  |  | 





Sistema Up&Down: la rótula eleva la puerta cuando se abre, consiguiendo una apertura suave, sin roces con el suelo y sin deteriorar la goma.

Sistema Up&Down: a rótula eleva a porta quando se abre, conseguindo uma abertura suave, sem fricção com o solo e sem deteriorar a borracha.

# suite

SS1 | MAMPARA DE DUCHA: 1 PUERTA BATIENTE ENTRE PAREDES  
 DIVISÓRIA DE DUCHE: 1 PORTA DE ABRIR ENTRE PAREDE

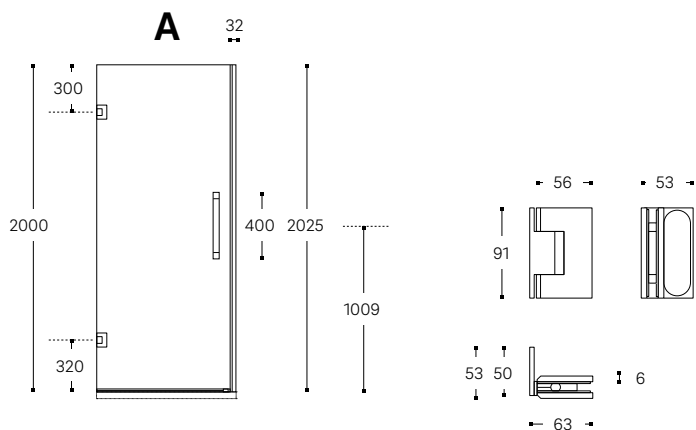

Dimensiones en mm.  
 Dimensões em mm.



VIDRIO TEMPLADO  
 VIDRO TEMPERADO  
**8** MM



TIRADOR  
 PUXADOR  
**400-700** MM



BISAGRAS CROMADAS  
 APERTURA **180°**  
 DOBRADIÇAS CROMADAS  
 ABERTURA **180°**



ALTURA ESTÁNDAR  
 ALTURA NORMA  
**2000** MM  
 ALTURA ESPECIAL  
 ALTURA ESTÁNDAR  
**HASTA / ATÉ 2500** MM



MEDIDAS Y ALTURAS ESPECIALES  
 MEDIDAS E ALTURAS ESPECIAIS  
**HASTA / ATÉ 2500** MM  
 (VER PÁG. / CONSULTA A PÁG. **372**)



TOALLERO TIRADOR OPCIONAL  
 TOALHEIRO PUXADOR OPCIONAL  
**400-700** MM



TRATAMIENTO INCLUIDO  
 TRATAMENTO INCLUIDO



MONTAJE  
 MONTAJEM  
**110** € \*

\* Preço recomendado  
 Código montaje **CSM08**  
 Para desplazamientos  
 consultar pág. **373**

\* Preço recomendado  
 Código montagem **CSM08**  
 Para deslocações  
 consultar pág. **373**

## ACABADOS METÁLICOS ACABAMENTOS METÁLICOS



BRILLO  
 BRILHO



NEGRO MATE  
 PRETO MATE



INOX MATE  
 INOX MATE

## TIRADOR PUXADOR



400 MM  
 500 MM  
 600 MM  
 700 MM

## TOALLERO-TIRADOR TOALHEIRO-PUXADOR



400 MM  
 500 MM  
 600 MM  
 700 MM

SS1

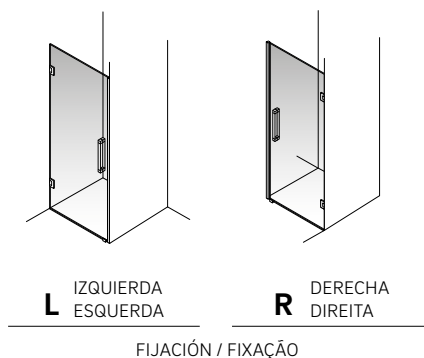

		<b>A mm</b>		
		<b>700-800</b>	<b>801-900</b>	<b>901-1000</b>
<b>PERFIL BRILLO PERFIL BRILHO</b>				
	Transparente	618 €	657 €	696 €
VIDRIO VIDRO	Affumicato, Bronce, Mate, Transp. decorado	742 €	788 €	835 €
	Affumicato decorado Bronce decorado Nuevos / Novos decorados *	834 €	887 €	940 €
	<b>PERFIL NEGRO MATE   PERFIL INOX MATE PERFIL PRETO MATE   PERFIL INOX MATE</b>			
	Transparente	749 €	796 €	842 €
VIDRIO VIDRO	Affumicato, Bronce, Mate, Transp. decorado	899 €	955 €	1.010 €
	Affumicato decorado Bronce decorado Nuevos / Novos decorados *	1.011 €	1.075 €	1.137 €

<b>TIRADOR PARA PUERTA PUXADOR PARA PORTA</b>		<b>400</b>	<b>500</b>	<b>600</b>	<b>700</b>
BRILLO BRILHO	Incluido / Incluso		+17 €	+33 €	+50 €
NEGRO MATE / INOX MATE PRETO MATE / INOX MATE	Incluido / Incluso		+17 €	+33 €	+50 €
<b>TOALLERO/TIRADOR OPCIONAL PARA LA PUERTA TOALHEIRO/PUXADOR OPCIONAL PARA PORTA</b>					
		<b>400</b>	<b>500</b>	<b>600</b>	<b>700</b>
BRILLO BRILHO		+11 €	+28 €	+44 €	+61 €
NEGRO MATE / INOX MATE PRETO MATE / INOX MATE		+11 €	+28 €	+44 €	+61 €
MÁX. TOALLERO/TIRADOR mm MÁX. TOALHEIRO/PUXADOR mm		700-1000	700-1000	700-1000	700-1000

Estos precios incluyen un tirador de 400mm en el mismo acabado que el perfil de la mampara.

Estes valores incluem um puxador de 400mm do mesmo acabamento do perfil da divisória.

\* Para serigrafías digitales confirmar precio con ATC. / Para serigrafías digitais confirmar preço com ATC.

**VIDRIO Y DECORADO  
VIDRO E DECORADO**



**NUEVOS DECORADOS  
NOVOS DECORADOS**



# suite

SS6

MAMPARA DE DUCHA: 1 PUERTA BATIENTE MÁS LATERAL A LA PUERTA  
DIVISÓRIA DE DUCHE 1 PORTA DE ABRIR MAIS LATERAL A LA PORTA

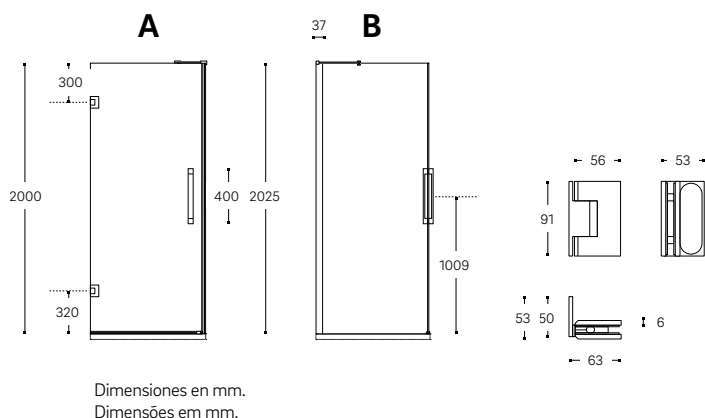

VIDRIO TEMPLADO  
VIDRO TEMPERADO  
8 MM



TIRADOR  
PUXADOR  
400-700 MM



BISAGRAS CROMADAS  
APERTURA 180°  
DOBRADIÇAS CROMADAS  
ABERTURA 180°



ALTURA ESTÁNDAR  
ALTURA NORMA  
2000 MM  
ALTURA ESPECIAL  
ALTURA ESTÁNDAR  
HASTA / ATÉ 2500 MM



MEDIDAS Y ALTURAS ESPECIALES  
MEDIDAS E ALTURAS ESPECIAIS  
HASTA / ATÉ 2500 MM  
(VER PÁG. / CONSULTA A PÁG. 372)



TOALLERO TIRADOR OPCIONAL  
TOALHEIRO PUXADOR OPCIONAL  
400-700 MM



TRATAMIENTO INCLUIDO  
TRATAMENTO INCLUIDO



MONTAJE  
MONTAJEM  
135 € \*

\* Precio recomendado  
Código montaje **CSM13**  
Para desplazamientos  
consultar pág. 373

\* Preço recomendado  
Código montagem **CSM13**  
Para deslocações  
consultar pág. 373

## ACABADOS METÁLICOS ACABAMENTOS METÁLICOS



BRILLO  
BRILHO



NEGRO MATE  
PRETO MATE



INOX MATE  
INOX MATE

## TIRADOR PUXADOR



400 MM  
500 MM  
600 MM  
700 MM

## TOALLERO-TIRADOR TOALHEIRO-PUXADOR

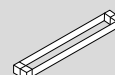

400 MM  
500 MM  
600 MM  
700 MM

## SS6 | FRONTAL

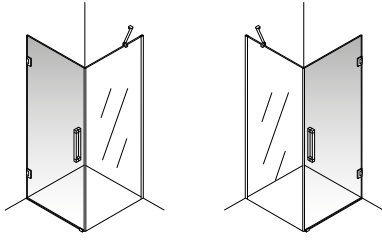

**L** IZQUIERDA  
ESQUERDA

**R** DERECHA  
DIREITA

FIJACIÓN / FIXAÇÃO

Estos precios incluyen un tirador de 400mm en el mismo acabado que el perfil de la mampara.

Estes valores incluem um puxador de 400mm do mesmo acabamento do perfil da divisória.

**A** mm

PERFIL BRILLO PERFIL BRILHO		600-700	701-800	801-900	901-1000
VIDRIO VIDRO	Transparente	578 €	618 €	657 €	696 €
	Affumicato, Bronce, Mate, Transp. decorado	694 €	742 €	788 €	835 €
	Affumicato decorado Bronce decorado Nuevos / Novos decorados *	780 €	834 €	887 €	940 €
PERFIL NEGRO MATE PERFIL PRETO MATE		PERFIL INOX MATE PERFIL INOX MATE			
VIDRIO VIDRO	Transparente	701 €	749 €	796 €	842 €
	Affumicato, Bronce, Mate, Transp. decorado	841 €	899 €	955 €	1.010 €
	Affumicato decorado Bronce decorado Nuevos / Novos decorados *	946 €	1.011 €	1.075 €	1.137 €

### TIRADOR PARA PUERTA PUXADOR PARA PORTA

	400	500	600	700
BRILLO PERFIL BRILHO	Incluido / Incluso	+17 €	+33 €	+50 €
NEGRO MATE / INOX MATE PRETO MATE / INOX MATE	Incluido / Incluso	+17 €	+33 €	+50 €

### TOALLERO/TIRADOR OPCIONAL PARA LA PUERTA TOALHEIRO/PUXADOR OPCIONAL PARA PORTA

	400	500	600	700
BRILLO BRILHO	+11 €	+28 €	+44 €	+61 €
NEGRO MATE / INOX MATE PRETO MATE / INOX MATE	+11 €	+28 €	+44 €	+61 €
MÁX. TOALLERO/TIRADOR mm MÁX. TOALHEIRO/PUXADOR mm	600-100	701-100	801-1000	901-1000

## SLB | LATERAL

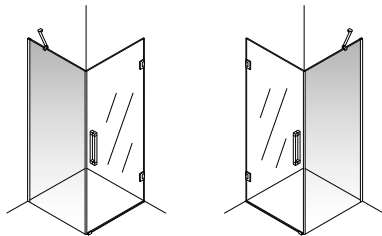

**L** IZQUIERDA  
ESQUERDA

**R** DERECHA  
DIREITA

FIJACIÓN / FIXAÇÃO

\*\* Ver página 371 para más información de cómo solicitar el toallero opcional.

\*\* Consulta a página 371 para mais informações sobre como solicitar o toalheiro opcional.

**B** mm

PERFIL BRILLO PERFIL BRILHO		200-500	501-600	601-800	801-1000	1001-1200
VIDRIO VIDRO	Transparente	275 €	315 €	388 €	444 €	500 €
	Affumicato, Bronce, Mate, Transp. decorado	330 €	378 €	466 €	533 €	600 €
	Affumicato decorado Bronce decorado Nuevos / Novos decorados *	371 €	425 €	524 €	599 €	675 €
NEGRO MATE PRETO MATE		PERFIL INOX MATE PERFIL INOX MATE				
VIDRIO VIDRO	Transparente	337 €	384 €	471 €	537 €	607 €
	Affumicato, Bronce, Mate, Transp. decorado	404 €	461 €	565 €	644 €	728 €
	Affumicato decorado Bronce decorado Nuevos / Novos decorados *	455 €	518 €	636 €	725 €	819 €

### TOALLERO OPCIONAL PARA LATERAL\*\* TOALHEIRO OPCIONAL PARA LATERAL\*\*

	400	500	600	700	
BRILLO BRILHO	+83 €	+94 €	+105 €	+116 €	
NEGRO MATE / INOX MATE PRETO MATE / INOX MATE	+83 €	+94 €	+105 €	+116 €	
MEDIDAS LATERAL mm	200-500	501-1200	601-1200	801-1200	1001-1200

\* Para serigrafías digitales confirmar precio con ATC. / Para serigrafias digitais confirmar preço com ATC.

### VIDRIO Y DECORADO VIDRO E DECORADO



### NUEVOS DECORADOS NOVOS DECORADOS



# suite

SSU

MAMPARA DE DUCHA: 1 PUERTA BATIENTE MÁS LATERAL AL EJE DE LA PUERTA  
DIVISÓRIA DE DUCHE: 1 PORTA DE ABRIR MAIS LATERAL AO EIXO DA PORTA

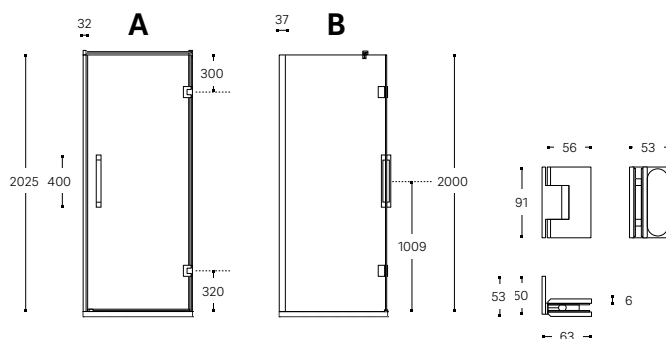

Dimensiones en mm.  
Dimensões em mm.



VIDRIO TEMPLADO  
VIDRO TEMPERADO  
8 MM



TIRADOR  
PUXADOR  
400-700 MM



BISAGRAS CROMADAS  
APERTURA 180°  
DOBRADIÇAS CROMADAS  
ABERTURA 180°



ALTURA ESTÁNDAR  
ALTURA NORMA  
2000 MM  
ALTURA ESPECIAL  
ALTURA ESTÁNDAR  
HASTA / ATÉ 2500 MM



MEDIDAS Y ALTURAS ESPECIALES  
MEDIDAS E ALTURAS ESPECIAIS  
HASTA / ATÉ 2500 MM  
(VER PÁG. / CONSULTA A PÁG. 372)



TOALLERO TIRADOR OPCIONAL  
TOALHEIRO PUXADOR OPCIONAL  
400-700 MM



TRATAMIENTO INCLUIDO  
TRATAMENTO INCLUIDO



MONTAJE  
MONTAJEM  
135 € \*

\* Precio recomendado  
Código montaje **CSM13**  
Para desplazamientos  
consultar pág. 373

\* Preço recomendado  
Código montagem **CSM13**  
Para deslocações  
consultar pág. 373

## ACABADOS METÁLICOS ACABAMENTOS METÁLICOS



BRILLO  
BRILHO



NEGRO MATE  
PRETO MATE

## TIRADOR PUXADOR



400 MM  
500 MM  
600 MM  
700 MM

## TOALLERO-TIRADOR TOALHEIRO-PUXADOR

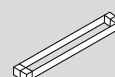

400 MM  
500 MM  
600 MM  
700 MM



## SSU | FRONTAL

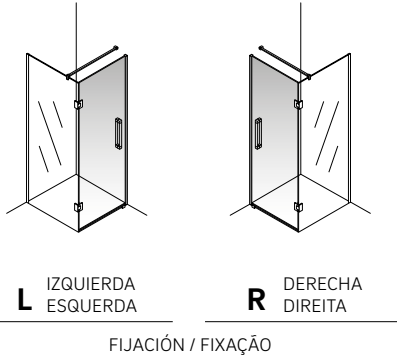

Estos precios incluyen un tirador de 400mm en el mismo acabado que el perfil de la mampara.  
Estes valores incluem um puxador de 400mm do mesmo acabamento do perfil da divisória.

### A mm

PERFIL BRILLO PERFIL BRILHO		600-700	701-800	801-900	901-1000
VIDRIO VIDRO	Transparente	578 €	618 €	657 €	696 €
	Affumicato, Bronce, Mate, Transp. decorado	694 €	742 €	788 €	835 €
	Affumicato decorado Bronce decorado Nuevos / Novos decorados *	780 €	834 €	887 €	940 €

### PERFIL NEGRO MATE PERFIL PRETO MATE

VIDRIO VIDRO	Transparente	701 €	749 €	796 €	842 €
	Affumicato, Bronce, Mate, Transp. decorado	841 €	899 €	955 €	1.010 €
	Affumicato decorado Bronce decorado Nuevos / Novos decorados *	946 €	1.011 €	1.075 €	1.137 €

### TIRADOR PARA PUERTA PUXADOR PARA PORTA

	400	500	600	700
BRILLO BRILHO	Incluido / Incluso	+17 €	+33 €	+50 €
NEGRO MATE PRETO MATE	Incluido / Incluso	+17 €	+33 €	+50 €

### TOALLERO/TIRADOR OPCIONAL PARA LA PUERTA TOALHEIRO/PUXADOR OPCIONAL PARA PORTA

	400	500	600	700
BRILLO BRILHO	+11 €	+28 €	+44 €	+61 €
NEGRO MATE PRETO MATE	+11 €	+28 €	+44 €	+61 €
MÁX. TOALLERO/TIRADOR mm MÁX. TOALHEIRO/PUXADOR mm	600-100	701-100	801-1000	901-1000

## SLU | LATERAL

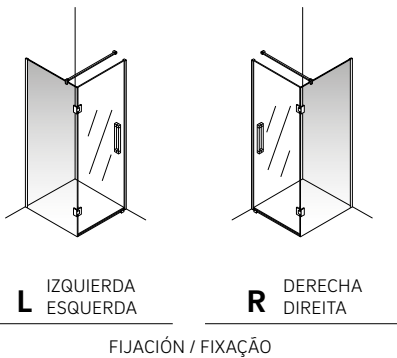

\*\* Ver página 371 para más información de cómo solicitar el toallero opcional.

\*\* Consulta a página 371 para mais informações sobre como solicitar o toalheiro opcional.

### B mm

PERFIL BRILLO PERFIL BRILHO		200-500	501-600	601-800	801-1000	1001-1200
VIDRIO VIDRO	Transparente	483 €	505 €	550 €	607 €	663 €
	Affumicato, Bronce, Mate, Transp. decorado	580 €	606 €	660 €	728 €	796 €
	Affumicato decorado Bronce decorado Nuevos / Novos decorados *	652 €	682 €	743 €	819 €	895 €

### NEGRO MATE PRETO MATE

VIDRIO VIDRO	Transparente	483 €	612 €	666 €	737 €	802 €
	Affumicato, Bronce, Mate, Transp. decorado	580 €	734 €	799 €	884 €	962 €
	Affumicato decorado Bronce decorado Nuevos / Novos decorados *	652 €	826 €	899 €	995 €	1.083 €

### TOALLERO OPCIONAL PARA LATERAL\*\* TOALHEIRO OPCIONAL PARA LATERAL\*\*

	-	400	500	600	700
BRILLO BRILHO	-	+83 €	+94 €	+105 €	+116 €
NEGRO MATE PRETO MATE	-	+83 €	+94 €	+105 €	+116 €
MEDIDAS LATERAL mm	200-500	501-1200	601-1200	801-1200	1001-1200

\* Para serigrafías digitales confirmar precio con ATC. / Para serigrafias digitais confirmar preço com ATC.

### VIDRIO Y DECORADO VIDRO E DECORADO



### NUEVOS DECORADOS NOVOS DECORADOS



# suite

SSD | MAMPARA DE DUCHA: 2 PUERTAS BATIENTES ENTRE PAREDES  
 DIVISÓRIA DE DUCHE: 2 PORTAS DE ABRIR ENTRE PAREDE

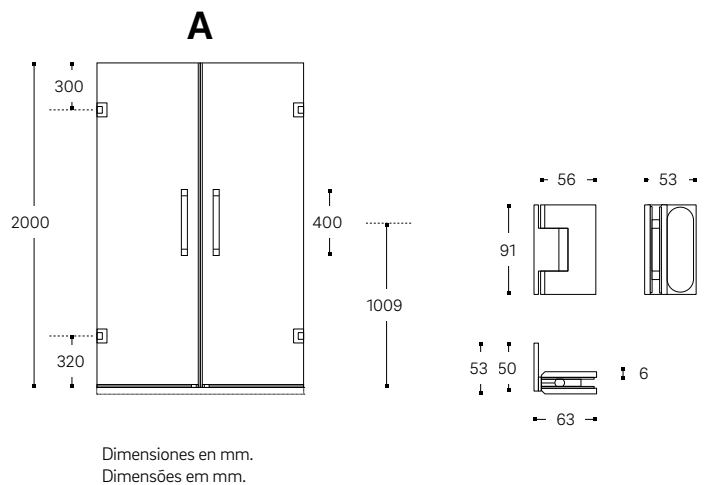

VIDRIO TEMPLADO  
 VIDRO TEMPERADO  
**8 MM**



TIRADOR  
 PUXADOR  
**400-700 MM**



BISAGRAS CROMADAS  
 APERTURA **180°**  
 DOBRADIÇAS CROMADAS  
 ABERTURA **180°**



ALTURA ESTÁNDAR  
 ALTURA NORMA  
**2000 MM**  
 ALTURA ESPECIAL  
 ALTURA ESTÁNDAR  
**HASTA / ATÉ 2500 MM**



MEDIDAS Y ALTURAS ESPECIALES  
 MEDIDAS E ALTURAS ESPECIAIS  
**HASTA / ATÉ 2500 MM**  
 (VER PÁG. / CONSULTA A PÁG. **372**)



TOALLERO TIRADOR OPCIONAL  
 TOALHEIRO PUXADOR OPCIONAL  
**400-600 MM**



TRATAMIENTO INCLUIDO  
 TRATAMENTO INCLUIDO



MONTAJE  
 MONTAJEM  
**115 € \***

\* Preço recomendado  
 Código montagem **CSM09**  
 Para deslocamentos  
 consultar pág. **373**

\* Preço recomendado  
 Código montagem **CSM09**  
 Para deslocações  
 consultar pág. **373**

## ACABADOS METÁLICOS ACABAMENTOS METÁLICOS



BRILLO  
 BRILHO



NEGRO MATE  
 PRETO MATE



INOX MATE  
 INOX MATE

## TIRADOR PUXADOR



400 MM  
 500 MM  
 600 MM  
 700 MM

## TOALLERO-TIRADOR TOALHEIRO-PUXADOR



400 MM  
 500 MM  
 600 MM

# SSD | FRONTAL

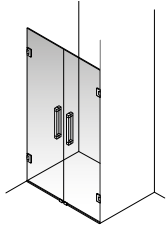

A mm

PERFIL BRILLO PERFIL BRILHO		800-1000	1001-1200	1201-1400	1401-1600
VIDRIO VIDRO	Transparente	999 €	1.077 €	1.157 €	1.235 €
	Affumicato, Bronce, Mate, Transp. decorado	1.199 €	1.292 €	1.388 €	1.482 €
	Affumicato decorado Bronce decorado Nuevos / Novos decorados *	1.349 €	1.454 €	1.562 €	1.667 €
PERFIL NEGRO MATE   PERFIL INOX MATE PERFIL PRETO MATE   PERFIL INOX MATE		800-1000	1001-1200	1201-1400	1401-1600
VIDRIO VIDRO	Transparente	1.209 €	1.302 €	1.397 €	1.490 €
	Affumicato, Bronce, Mate, Transp. decorado	1.451 €	1.562 €	1.676 €	1.788 €
	Affumicato decorado Bronce decorado Nuevos / Novos decorados *	1.632 €	1.758 €	1.886 €	2.012 €

TIRADORES PARA PUERTAS (2 UDS) PUXADORES PARA PORTAS (2 UDS)	400	500	600	700
BRILLO BRILHO	Incluido / Incluso	+33 €	+66 €	+99 €
NEGRO MATE / INOX MATE PRETO MATE / INOX MATE	Incluido / Incluso	+33 €	+66 €	+99 €
TOALLERO/TIRADOR OPCIONAL PARA PUERTAS (2 UDS) TOALHEIRO/PUXADOR OPCIONAL PARA PORTA (2 UDS)	400	500	600	700
BRILLO BRILHO	-	+28 €	+44 €	+61 €
NEGRO MATE / INOX MATE PRETO MATE / INOX MATE	-	+28 €	+44 €	+61 €
MÁX. TOALLERO/TIRADOR mm MAX. TOALHEIRO/PUXADOR mm	900-1600	1101-1600	1301-1600	1501-1600

Estos precios incluyen 2 tiradores de 400mm en el mismo acabado que el perfil de la mampara.  
Estos valores incluyen 2 puxadores de 400mm do mesmo acabamento do perfil da divisória.

\* Para serigrafías digitales confirmar precio con ATC. / Para serigrafias digitais confirmar preço com ATC.

## VIDRIO Y DECORADO VIDRO E DECORADO

TRANSP.	AFFUMICATO	BRONCE	MATE
SIN DECORADO	SIN DECORADO	SIN DECORADO	SIN DECORADO
PICTOR	PICTOR	PICTOR	

## NUEVOS DECORADOS NOVOS DECORADOS

SERIGRAFÍAS ESPECIALES		SERIGRAFÍAS DIGITALES	
MIRAI	WETLANDS	BAMBOO	WAVE
GRID		FOG	

# suite

SSE | MAMPARA DE DUCHA: 2 PUERTAS BATIENTES MÁS LATERAL  
DIVISÓRIA DE DUCHE: 2 PORTAS DE ABRIR MAIS LATERAL

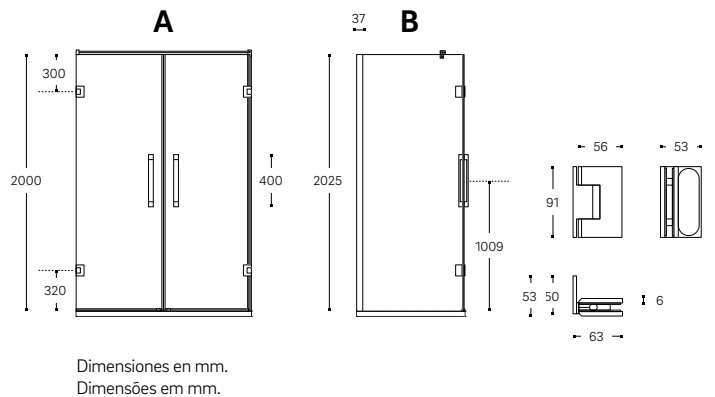

VIDRIO TEMPLADO  
VIDRO TEMPERADO  
8 MM



TIRADOR  
PUXADOR  
400-700 MM



BISAGRAS CROMADAS  
APERTURA 180°  
DOBRADIÇAS CROMADAS  
ABERTURA 180°



ALTURA ESTÁNDAR  
ALTURA NORMA  
2000 MM  
ALTURA ESPECIAL  
ALTURA ESTÁNDAR  
HASTA / ATÉ 2500 MM



MEDIDAS Y ALTURAS ESPECIALES  
MEDIDAS E ALTURAS ESPECIAIS  
HASTA / ATÉ 2500 MM  
(VER PÁG. / CONSULTA A PÁG. 372)



TOALLERO TIRADOR OPCIONAL  
TOALHEIRO PUXADOR OPCIONAL  
400-600 MM



TRATAMIENTO INCLUIDO  
TRATAMENTO INCLUIDO



MONTAJE  
MONTAJEM  
140 € \*

\* Precio recomendado  
Código montaje **CSM14**  
Para desplazamientos  
consultar pág. 373

\* Preço recomendado  
Código montagem **CSM14**  
Para deslocações  
consultar pág. 373

## ACABADOS METÁLICOS ACABAMENTOS METÁLICOS



BRILLO  
BRILHO



NEGRO MATE  
PRETO MATE

## TIRADOR PUXADOR



400 MM  
500 MM  
600 MM  
700 MM

## TOALLERO-TIRADOR TOALHEIRO-PUXADOR



400 MM  
500 MM  
600 MM

## SSE | FRONTAL

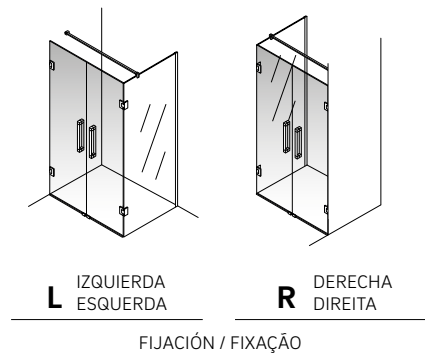

Estos precios incluyen 2 tiradores de 400mm en el mismo acabado que el perfil de la mampara.  
Estos valores incluem 2 puxadores de 400mm do mesmo acabamento do perfil da divisória.

		A mm			
		800-1000	1001-1200	1201-1400	1401-1600
<b>PERFIL BRILLO</b>					
<b>PERFIL BRILHO</b>					
	Transparente	999 €	1.077 €	1.157 €	1.235 €
VIDRIO VIDRO	Affumicato, Bronce, Mate, Transp. decorado	1.199 €	1.292 €	1.388 €	1.482 €
	Affumicato decorado Bronce decorado Nuevos / Novos decorados *	1.349 €	1.454 €	1.562 €	1.667 €
<b>PERFIL NEGRO MATE</b>					
<b>PERFIL PRETO MATE</b>					
	Transparente	1.209 €	1.302 €	1.397 €	1.490 €
VIDRIO VIDRO	Affumicato, Bronce, Mate, Transp. decorado	1.451 €	1.562 €	1.676 €	1.788 €
	Affumicato decorado Bronce decorado Nuevos / Novos decorados *	1.632 €	1.758 €	1.886 €	2.012 €

<b>TIRADORES PARA PUERTAS (2 UDS)</b>					
<b>PUXADORES PARA PORTAS (2 UDS)</b>		400	500	600	700
BRILLO BRILHO	Incluido / Incluso		+33 €	+66 €	+99 €
NEGRO MATE PRETO MATE	Incluido / Incluso		+33 €	+66 €	+99 €
<b>TOALLERO/TIRADOR OPCIONAL PARA PUERTAS (2 UDS)</b>					
<b>TOALHEIRO/PUXADOR OPCIONAL PARA PORTAS (2 UDS)</b>					
		400	500	600	
BRILLO BRILHO		+28 €	+44 €	+61 €	
NEGRO MATE PRETO MATE		+28 €	+44 €	+61 €	
MÁX. TOALLERO/TIRADOR mm		800-900	901-1600	1101-1600	1501-1600
MÁX. TOALHEIRO/PUXADOR mm					

## SLU | LATERAL

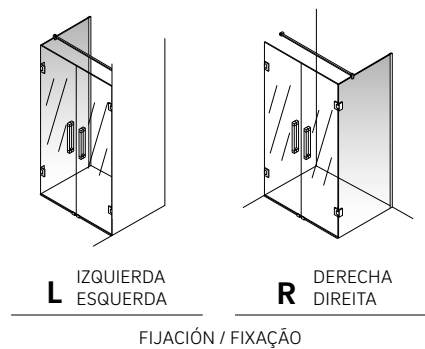

\*\* Ver página 371 para más información de cómo solicitar el toallero opcional.  
\*\* Consulta a página 371 para mais informações sobre como solicitar o toalheiro opcional.

		B mm				
		200-500	501-600	601-800	801-1000	1001-1200
<b>PERFIL BRILLO</b>						
<b>PERFIL BRILHO</b>						
	Transparente	483 €	505 €	550 €	607 €	663 €
VIDRIO VIDRO	Affumicato, Bronce, Mate, Transp. decorado	580 €	606 €	660 €	728 €	796 €
	Affumicato decorado Bronce decorado Nuevos / Novos decorados *	652 €	682 €	743 €	819 €	895 €
<b>NEGRO MATE</b>						
<b>PRETO MATE</b>						
	Transparente	483 €	612 €	666 €	737 €	802 €
VIDRIO VIDRO	Affumicato, Bronce, Mate, Transp. decorado	580 €	734 €	799 €	884 €	962 €
	Affumicato decorado Bronce decorado Nuevos / Novos decorados *	652 €	826 €	899 €	995 €	1.083 €
<b>TOALLERO OPCIONAL PARA LATERAL**</b>						
<b>TOALHEIRO OPCIONAL PARA LATERAL**</b>						
		400	500	600	700	
BRILLO BRILHO		-	+83 €	+94 €	+105 €	+116 €
NEGRO MATE PRETO MATE		-	+83 €	+94 €	+105 €	+116 €
MEDIDAS LATERAL mm		200-500	501-1200	601-1200	801-1200	1001-1200

\* Para serigrafías digitales confirmar precio con ATC. / Para serigrafías digitais confirmar preço com ATC.

### VIDRIO Y DECORADO VIDRO E DECORADO



### NUEVOS DECORADOS NOVOS DECORADOS



# suite

SSR | MAMPARA DE DUCHA: 1 PUERTA BATIENTE Y UN FIJO ENTRE PAREDES  
 DIVISÓRIA DE DUCHE: 1 PORTA DE ABRIR E 1 FIXO ENTRE PAREDE

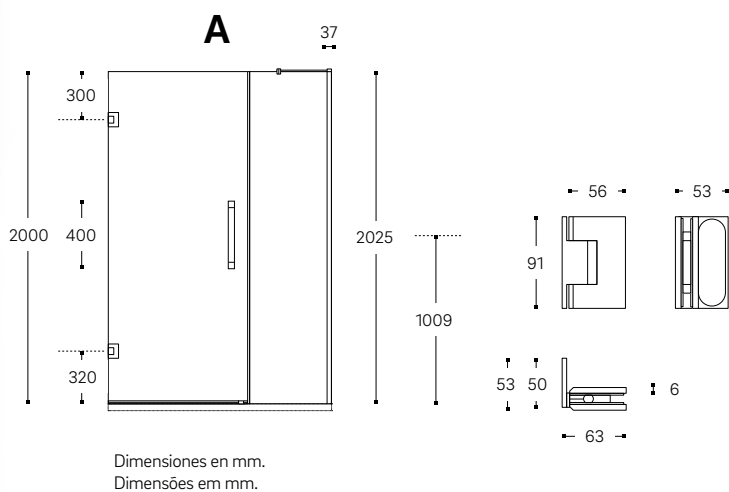

VIDRIO TEMPLADO  
 VIDRO TEMPERADO  
**8 MM**



TIRADOR  
 PUXADOR  
**400-700 MM**



BISAGRAS CROMADAS  
 APERTURA **180°**  
 DOBRADIÇAS CROMADAS  
 ABERTURA **180°**



ALTURA ESTÁNDAR  
 ALTURA NORMA  
**2000 MM**  
 ALTURA ESPECIAL  
 ALTURA ESTÁNDAR  
**HASTA / ATÉ 2500 MM**



MEDIDAS Y ALTURAS ESPECIALES  
 MEDIDAS E ALTURAS ESPECIAIS  
**HASTA / ATÉ 2500 MM**  
 (VER PÁG. / CONSULTA A PÁG. **372**)



TOALLERO TIRADOR OPCIONAL  
 TOALHEIRO PUXADOR OPCIONAL  
**400-700 MM**



TRATAMIENTO INCLUIDO  
 TRATAMENTO INCLUIDO



MONTAJE  
 MONTAJEM  
**115 €\***

\* Preço recomendado  
 Código montagem **CSM09**  
 Para deslocamentos  
 consultar pág. **373**

\* Preço recomendado  
 Código montagem **CSM09**  
 Para deslocações  
 consultar pág. **373**

## ACABADOS METÁLICOS ACABAMENTOS METÁLICOS



BRILLO  
 BRILHO



NEGRO MATE  
 PRETO MATE



INOX MATE  
 INOX MATE

## TIRADOR PUXADOR



400 MM  
 500 MM  
 600 MM  
 700 MM

## TOALLERO-TIRADOR TOALHEIRO-PUXADOR

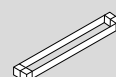

400 MM  
 500 MM  
 600 MM  
 700 MM

# SSR

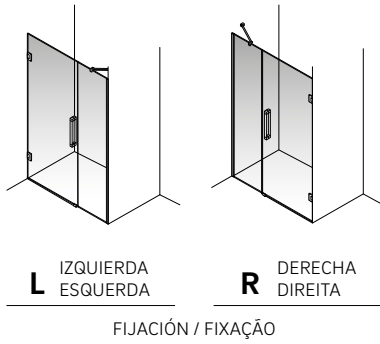

**A mm**

PERFIL BRILLO PERFIL BRILHO		800-900	901-1100	1101-1300	1301-1600	1601-1800	1801-2000
VIDRIO VIDRO	Transparente	802 €	825 €	853 €	920 €	1.021 €	1.083 €
	Affumicato, Bronce, Mate, Transp. decorado	962 €	990 €	1.024 €	1.104 €	1.225 €	1.300 €
	Affumicato decorado Bronce decorado Nuevos / Novos decorados *	1.083 €	1.114 €	1.152 €	1.242 €	1.378 €	1.462 €
PERFIL NEGRO MATE PERFIL PRETO MATE		PERFIL INOX MATE PERFIL INOX MATE					
VIDRIO VIDRO	Transparente	973 €	1.002 €	1.032 €	1.114 €	1.238 €	1.308 €
	Affumicato, Bronce, Mate, Transp. decorado	1.168 €	1.202 €	1.238 €	1.337 €	1.486 €	1.570 €
	Affumicato decorado Bronce decorado Nuevos / Novos decorados *	1.314 €	1.353 €	1.393 €	1.504 €	1.671 €	1.766 €
ENTRADA MÍNIMA mm / ENTRADA MÍNIMO mm		500	600	600	700	800	800

TIRADOR PARA PUERTA mm PUXADOR PARA PORTA mm	400	500	600	700	
BRILLO BRILHO	Incluido / Incluso	+17 €	+33 €	+50 €	
NEGRO MATE / INOX MATE PRETO MATE / INOX MATE	Incluido / Incluso	+17 €	+33 €	+50 €	
TOALLERO/TIRADOR OPCIONAL PARA PUERTA TOALHEIRO/PUXADOR OPCIONAL PARA PORTA	400	500	600	700	
BRILLO BRILHO	+11 €	+28 €	+44 €	+61 €	
NEGRO MATE / INOX MATE PRETO MATE / INOX MATE	+11 €	+28 €	+44 €	+61 €	
MÁX. TOALLERO/TIRADOR mm MAX. TOALHEIRO/PUXADOR mm	800-900	901-2000	1301-2000	1601-2000	
TOALLERO OPCIONAL ** TOALHEIRO OPCIONAL **	-	400	500	600	700
BRILLO BRILHO	-	+83 €	+94 €	+105 €	+116 €
NEGRO MATE / INOX MATE PRETO MATE / INOX MATE	-	+83 €	+94 €	+105 €	+116 €
MÁX. TOALLERO/TIRADOR mm MAX. TOALHEIRO/PUXADOR mm	800-1100	1101-2000	1301-2000	1601-2000	1801-2000

Estos precios incluyen un tirador de 400mm en el mismo acabado que el perfil de la mampara.

Estos valores incluyen um puxador de 400mm do mesmo acabamento do perfil da divisória.

\*\* Ver página 371 para más información de cómo solicitar el toallero opcional.

\*\* Consulta a página 371 para mais informações sobre como solicitar o toalheiro opcional.

\* Para serigrafías digitales confirmar precio con ATC. / Para serigrafías digitais confirmar preço com ATC.

## VIDRIO Y DECORADO VIDRO E DECORADO

TRANSP.	AFFUMICATO	BRONCE	MATE
SIN DECORADO	SIN DECORADO	SIN DECORADO	SIN DECORADO
PICTOR	PICTOR	PICTOR	

## NUEVOS DECORADOS NOVOS DECORADOS

SERIGRAFÍAS ESPECIALES		SERIGRAFÍAS DIGITALES	
MIRAI	WETLANDS	BAMBOO	WAVE
GRID		FOG	

# suite

SST | MAMPARA DE DUCHA: 1 PUERTA BATIENTE Y UN FIJO MÁS LATERAL  
 DIVISÓRIA DE DUCHE: 1 PORTA DE ABRIR E 1 FIXO MAIS LATERAL

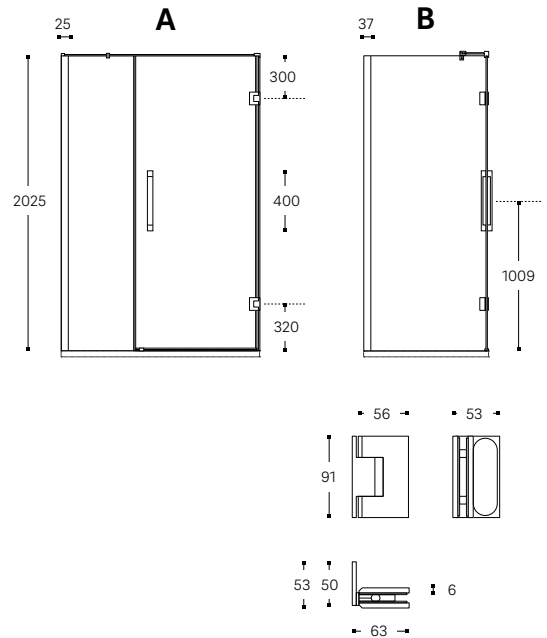

Dimensiones en mm.  
 Dimensões em mm.



VIDRIO TEMPLADO  
 VIDRO TEMPERADO  
**8** MM



TIRADOR  
 PUXADOR  
**400-700** MM



BISAGRAS CROMADAS  
 APERTURA **180°**  
 DOBRADIÇAS CROMADAS  
 ABERTURA **180°**



ALTURA ESTÁNDAR  
 ALTURA NORMA  
**2000** MM  
 ALTURA ESPECIAL  
 ALTURA ESTÁNDAR  
**HASTA / ATÉ 2500** MM



MEDIDAS Y ALTURAS ESPECIALES  
 MEDIDAS E ALTURAS ESPECIAIS  
**HASTA / ATÉ 2500** MM  
 (VER PÁG. / CONSULTA A PÁG. **372**)



TOALLERO TIRADOR OPCIONAL  
 TOALHEIRO PUXADOR OPCIONAL  
**400-700** MM



TRATAMIENTO INCLUIDO  
 TRATAMENTO INCLUIDO



MONTAJE  
 MONTAJEM  
**140 € \***

\* Precio recomendado  
 Código montaje **CSM14**  
 Para desplazamientos  
 consultar pág. **373**

\* Preço recomendado  
 Código montagem **CSM14**  
 Para deslocações  
 consultar pág. **373**

## ACABADOS METÁLICOS ACABAMENTOS METÁLICOS



BRILLO  
 BRILHO



NEGRO MATE  
 PRETO MATE

## TIRADOR PUXADOR



400 MM  
 500 MM  
 600 MM  
 700 MM

## TOALLERO-TIRADOR TOALHEIRO-PUXADOR

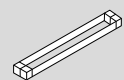

400 MM  
 500 MM  
 600 MM  
 700 MM



## SST | FRONTAL

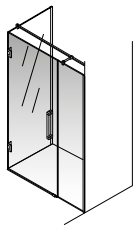

**L** IZQUIERDA  
ESQUERDA

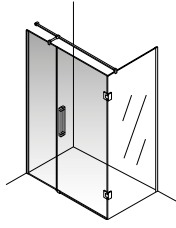

**R** DERECHA  
DIREITA

FIJACIÓN / FIXAÇÃO

Estos precios incluyen un tirador de 400mm en el mismo acabado que el perfil de la mampara.  
Estos valores incluem um puxador de 400mm do mesmo acabamento do perfil da divisória.

## SLU | LATERAL

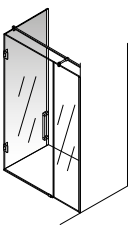

**L** IZQUIERDA  
ESQUERDA

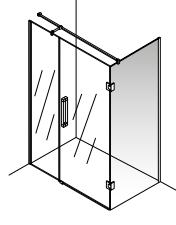

**R** DERECHA  
DIREITA

FIJACIÓN / FIXAÇÃO

\*\* Ver página 371 para más información de cómo solicitar el toallero opcional.

\*\* Consulta a página 371 para mais informações sobre como solicitar o toalheiro opcional.

**A mm**

PERFIL BRILLO PERFIL BRILHO		800-900	901-1100	1101-1300	1301-1600	1601-1800	1801-2000
VIDRIO VIDRO	Transparente	802 €	825 €	853 €	920 €	1.021 €	1.083 €
	Affumicato, Bronce, Mate, Transp. decorado	962 €	990 €	1.024 €	1.104 €	1.225 €	1.300 €
	Affumicato decorado Bronce decorado Nuevos / Novos decorados *	1.083 €	1.114 €	1.152 €	1.242 €	1.378 €	1.462 €
PERFIL NEGRO MATE PERFIL PRETO MATE							
VIDRIO VIDRO	Transparente	973 €	1.002 €	1.032 €	1.114 €	1.238 €	1.308 €
	Affumicato, Bronce, Mate, Transp. decorado	1.168 €	1.202 €	1.238 €	1.337 €	1.486 €	1.570 €
	Affumicato decorado Bronce decorado Nuevos / Novos decorados *	1.314 €	1.353 €	1.393 €	1.504 €	1.671 €	1.766 €
ENTRADA MÍNIMA mm / ENTRADA MÍNIMO mm		500	600	600	700	800	800

TIRADOR PARA PUERTA mm PUXADOR PARA PORTA mm		400	500	600	700	
BRILLO BRILHO	Incluido / Incluso		+17 €	+33 €	+50 €	
NEGRO MATE PRETO MATE	Incluido / Incluso		+17 €	+33 €	+50 €	
TOALLERO/TIRADOR OPCIONAL PARA PUERTA TOALHEIRO/PUXADOR OPCIONAL PARA PORTA		400	500	600	700	
BRILLO BRILHO		+11 €	+28 €	+44 €	+61 €	
NEGRO MATE PRETO MATE		+11 €	+28 €	+44 €	+61 €	
MÁX. TOALLERO/TIRADOR mm MÁX. TOALHEIRO/PUXADOR mm		800-2000	901-2000	1301-2000	1601-2000	
TOALLERO OPCIONAL ** TOALHEIRO OPCIONAL**		-	400	500	600	700
BRILLO BRILHO		-	+83 €	+94 €	+105 €	+116 €
NEGRO MATE PRETO MATE		-	+83 €	+94 €	+105 €	+116 €
MÁX. TOALLERO/TIRADOR mm MÁX. TOALHEIRO/PUXADOR mm		800-1100	1101-2000	1301-2000	1601-2000	1801-2000

**B mm**

PERFIL BRILLO PERFIL BRILHO		200-500	501-600	601-800	801-1000	1001-1200
VIDRIO VIDRO	Transparente	483 €	505 €	550 €	607 €	663 €
	Affumicato, Bronce, Mate, Transp. decorado	580 €	606 €	660 €	728 €	796 €
	Affumicato decorado Bronce decorado Nuevos / Novos decorados *	652 €	682 €	743 €	819 €	895 €
PERFIL NEGRO MATE PERFIL PRETO MATE						
VIDRIO VIDRO	Transparente	483 €	612 €	666 €	737 €	802 €
	Affumicato, Bronce, Mate, Transp. decorado	580 €	734 €	799 €	884 €	962 €
	Affumicato decorado Bronce decorado Nuevos / Novos decorados *	652 €	826 €	899 €	995 €	1.083 €
TOALLERO OPCIONAL PARA LATERAL** TOALHEIRO OPCIONAL PARA LATERAL**		-	400	500	600	700
BRILLO BRILHO		-	+83 €	+94 €	+105 €	+116 €
NEGRO MATE PRETO MATE		-	+83 €	+94 €	+105 €	+116 €
MEDIDAS LATERAL mm		200-500	501-1200	601-1200	801-1200	1001-1200

\* Para serigrafías digitales confirmar precio con ATC. / Para serigrafias digitais confirmar preço com ATC.

### VIDRIO Y DECORADO VIDRO E DECORADO

TRANSP.



SIN DECORADO



PICTOR

AFFUMICATO



SIN DECORADO



PICTOR

BRONCE



SIN DECORADO



PICTOR

MATE



SIN DECORADO

### NUEVOS DECORADOS NOVOS DECORADOS

SERIGRAFÍAS ESPECIALES



MIRAI



WETLANDS



GRID

SERIGRAFÍAS DIGITALES



BAMBOO



WAVE



FOG

# suite

SS2 | MAMPARA DE DUCHA: 1 PUERTA BATIENTE Y UN FIJO ENTRE PAREDES  
 DIVISÓRIA DE DUCHE: 1 PORTA DE ABRIR E 1 FIXO ENTRE PAREDE

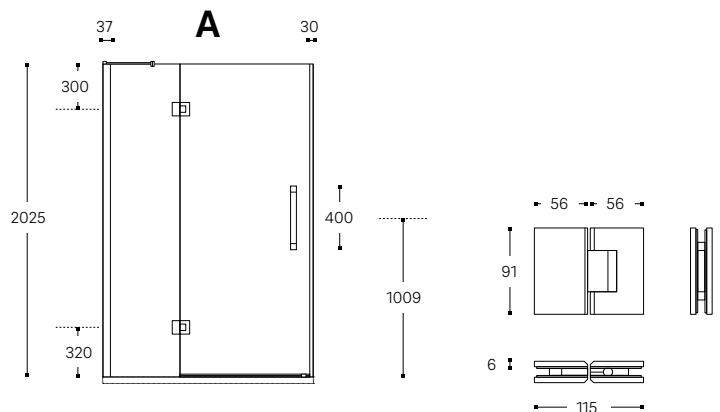

Dimensiones en mm.  
 Dimensões em mm.



VIDRIO TEMPLADO  
 VIDRO TEMPERADO  
**8 MM**



TIRADOR  
 PUXADOR  
**400-700 MM**



BISAGRAS CROMADAS  
 APERTURA **180°**  
 DOBRADIÇAS CROMADAS  
 ABERTURA **180°**



ALTURA ESTÁNDAR  
 ALTURA NORMA  
**2000 MM**  
 ALTURA ESPECIAL  
 ALTURA ESTÁNDAR  
**HASTA / ATÉ 2500 MM**



MEDIDAS Y ALTURAS ESPECIALES  
 MEDIDAS E ALTURAS ESPECIAIS  
**HASTA / ATÉ 2500 MM**  
 (VER PÁG. / CONSULTA A PÁG. **372**)



TOALLERO TIRADOR OPCIONAL  
 TOALHEIRO PUXADOR OPCIONAL  
**400-700 MM**



TRATAMIENTO INCLUIDO  
 TRATAMENTO INCLUIDO



MONTAJE  
 MONTAJEM  
**115 € \***

\* Preço recomendado  
 Código montaje **CSM09**  
 Para desplazamientos  
 consultar pág. **373**

\* Preço recomendado  
 Código montagem **CSM09**  
 Para deslocações  
 consultar pág. **373**

## ACABADOS METÁLICOS ACABAMENTOS METÁLICOS



BRILLO  
 BRILHO



NEGRO MATE  
 PRETO MATE



INOX MATE  
 INOX MATE

## TIRADOR PUXADOR



400 MM  
 500 MM  
 600 MM  
 700 MM

## TOALLERO-TIRADOR TOALHEIRO-PUXADOR



400 MM  
 500 MM  
 600 MM  
 700 MM

## SS2 | FRONTAL

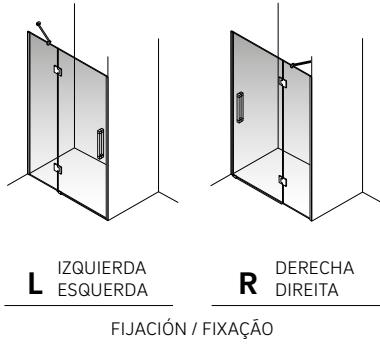

		A mm					
PERFIL BRILLO PERFIL BRILHO		800-900	901-1100	1101-1300	1301-1600	1601-1800	1801-2000
VIDRIO VIDRO	Transparente	909 €	932 €	954 €	1.021 €	1.111 €	1.179 €
	Affumicato, Bronce, Mate, Transp. decorado	1.091 €	1.118 €	1.145 €	1.225 €	1.333 €	1.415 €
	Affumicato decorado Bronce decorado Nuevos / Novos decorados *	1.227 €	1.258 €	1.288 €	1.378 €	1.500 €	1.592 €
PERFIL NEGRO MATE PERFIL PRETO MATE		PERFIL INOX MATE PERFIL INOX MATE					
VIDRIO VIDRO	Transparente	1.103 €	1.126 €	1.155 €	1.238 €	1.344 €	1.426 €
	Affumicato, Bronce, Mate, Transp. decorado	1.324 €	1.351 €	1.386 €	1.486 €	1.613 €	1.711 €
	Affumicato decorado Bronce decorado Nuevos / Novos decorados *	1.489 €	1.520 €	1.559 €	1.671 €	1.814 €	1.925 €
ENTRADA MÍNIMA mm / ENTRADA MÍNIMO mm		500	600	600	700	800	800

TIRADOR PARA PUERTA mm PUXADOR PARA PORTA mm		400	500	600	700	
BRILLO BRILHO	Incluido / Incluso		+17 €	+33 €	+50 €	
NEGRO MATE / INOX MATE PRETO MATE / INOX MATE	Incluido / Incluso		+17 €	+33 €	+50 €	
TOALLERO/TIRADOR OPCIONAL PARA PUERTA TOALHEIRO/PUXADOR OPCIONAL PARA PORTA		A mm				
		400	500	600	700	
BRILLO BRILHO		+11 €	+28 €	+44 €	+61 €	
NEGRO MATE / INOX MATE PRETO MATE / INOX MATE		+11 €	+28 €	+44 €	+61 €	
MÁX. TOALLERO/TIRADOR mm MÁX. TOALHEIRO/PUXADOR mm		800-900	901-2000	1301-2000	1601-2000	
TOALLERO OPCIONAL EN FIJO DEL FRONTAL** TOALHEIRO OPCIONAL EM FIJO DO FRONTAL**		-	400	500	600	700
BRILLO BRILHO		-	+83 €	+94 €	+105 €	+116 €
NEGRO MATE / INOX MATE PRETO MATE / INOX MATE		-	+83 €	+94 €	+105 €	+116 €
MÁX. TOALLERO/TIRADOR mm MÁX. TOALHEIRO/PUXADOR mm		200-1100	1101-2000	1301-2000	1601-2000	1801-2000

Estos precios incluyen un tirador de 400mm en el mismo acabado que el perfil de la mampara.

Estos valores incluem um puxador de 400mm do mesmo acabamento do perfil da divisória.

\*\* Ver página 371 para más información de cómo solicitar el toallero opcional.

\*\* Consulta a página 371 para mais informações sobre como solicitar o toalheiro opcional.

\* Para serigrafías digitales confirmar precio con ATC. / Para serigrafías digitais confirmar preço com ATC.

### VIDRIO Y DECORADO VIDRO E DECORADO

TRANSP.	AFFUMICATO	BRONCE	MATE
SIN DECORADO	SIN DECORADO	SIN DECORADO	SIN DECORADO
PICTOR	PICTOR	PICTOR	

### NUEVOS DECORADOS NOVOS DECORADOS

SERIGRAFÍAS ESPECIALES		SERIGRAFÍAS DIGITALES	
MIRAI	WETLANDS	BAMBOO	WAVE
GRID		FOG	

# suite

SS7 | MAMPARA DE DUCHA: 1 PUERTA BATIENTE Y UN FIJO MÁS LATERAL  
DIVISÓRIA DE DUCHE: 1 PORTA DE ABRIR E 1 FIXO MAIS LATERAL

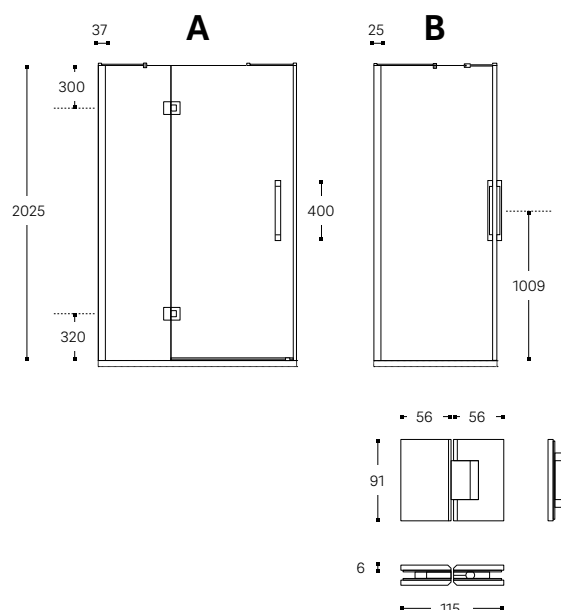

Dimensiones en mm.  
Dimensões em mm.



VIDRIO TEMPLADO  
VIDRO TEMPERADO  
8 MM



TIRADOR  
PUXADOR  
400-700 MM



BISAGRAS CROMADAS  
APERTURA 180°  
DOBRADIÇAS CROMADAS  
ABERTURA 180°



ALTURA ESTÁNDAR  
ALTURA NORMA  
2000 MM  
ALTURA ESPECIAL  
ALTURA ESTÁNDAR  
HASTA / ATÉ 2500 MM



MEDIDAS Y ALTURAS ESPECIALES  
MEDIDAS E ALTURAS ESPECIAIS  
HASTA / ATÉ 2500 MM  
(VER PÁG. / CONSULTA A PÁG. 372)



TOALLERO TIRADOR OPCIONAL  
TOALHEIRO PUXADOR OPCIONAL  
400-700 MM



TRATAMIENTO INCLUIDO  
TRATAMENTO INCLUIDO



MONTAJE  
MONTAJEM  
140 € \*

\* Precio recomendado  
Código montaje **CSM14**  
Para desplazamientos  
consultar pág. 373

\* Preço recomendado  
Código montagem **CSM14**  
Para deslocações  
consultar pág. 373

## ACABADOS METÁLICOS ACABAMENTOS METÁLICOS



BRILLO  
BRILHO



NEGRO MATE  
PRETO MATE



INOX MATE  
INOX MATE

## TIRADOR PUXADOR



400 MM  
500 MM  
600 MM  
700 MM

## TOALLERO-TIRADOR TOALHEIRO-PUXADOR

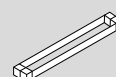

400 MM  
500 MM  
600 MM  
700 MM

## SS7 | FRONTAL

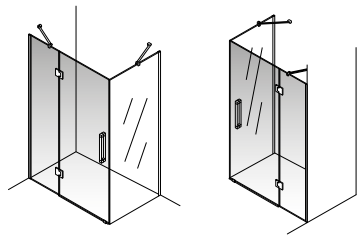

**L** IZQUIERDA  
ESQUERDA

**R** DERECHA  
DIREITA

FIJACIÓN / FIXAÇÃO

Estos precios incluyen un tirador de 400mm en el mismo acabado que el perfil de la mampara.

Estos valores incluem um puxador de 400mm do mesmo acabamento do perfil da divisória.

		A mm					
PERFIL BRILLO PERFIL BRILHO		800-900	901-1100	1101-1300	1301-1600	1601-1800	1801-2000
VIDRIO VIDRO	Transparente	909 €	932 €	954 €	1.021 €	1.111 €	1.179 €
	Affumicato, Bronce, Mate, Transp. decorado	1.091 €	1.118 €	1.145 €	1.225 €	1.333 €	1.415 €
	Affumicato decorado Bronce decorado Nuevos / Novos decorados *	1.227 €	1.258 €	1.288 €	1.378 €	1.500 €	1.592 €
PERFIL NEGRO MATE PERFIL PRETO MATE		PERFIL INOX MATE PERFIL INOX MATE					
VIDRIO VIDRO	Transparente	1.103 €	1.126 €	1.155 €	1.238 €	1.344 €	1.426 €
	Affumicato, Bronce, Mate, Transp. decorado	1.324 €	1.351 €	1.386 €	1.486 €	1.613 €	1.711 €
	Affumicato decorado Bronce decorado Nuevos / Novos decorados *	1.489 €	1.520 €	1.559 €	1.671 €	1.814 €	1.925 €
ENTRADA MÍNIMA mm / ENTRADA MÍNIMO mm		500	600	600	700	800	800

TIRADOR PARA PUERTA mm PUXADOR PARA PORTA mm		400	500	600	700	
BRILLO BRILHO	Incluido / Incluso		+17 €	+33 €	+50 €	
NEGRO MATE / INOX MATE PRETO MATE / INOX MATE	Incluido / Incluso		+17 €	+33 €	+50 €	
TOALLERO/TIRADOR OPCIONAL PARA PUERTA TOALHEIRO/PUXADOR OPCIONAL PARA PORTA		A mm				
		400	500	600	700	
BRILLO BRILHO		+11 €	+28 €	+44 €	+61 €	
NEGRO MATE / INOX MATE PRETO MATE / INOX MATE		+11 €	+28 €	+44 €	+61 €	
MÁX. TOALLERO/TIRADOR mm MAX. TOALHEIRO/PUXADOR mm		800-900	901-2000	1301-2000	1601-2000	
TOALLERO OPCIONAL EN FIJO DEL FRONTAL** TOALHEIRO OPCIONAL EM FIJO DO FRONTAL**		-	400	500	600	700
BRILLO BRILHO		-	+83 €	+94 €	+105 €	+116 €
NEGRO MATE / INOX MATE PRETO MATE / INOX MATE		-	+83 €	+94 €	+105 €	+116 €
MÁX. TOALLERO/TIRADOR mm MAX. TOALHEIRO/PUXADOR mm		200-1100	1101-2000	1301-2000	1601-2000	1801-2000

## SLB | LATERAL

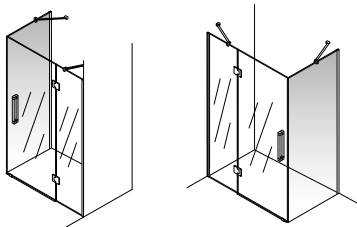

**L** IZQUIERDA  
ESQUERDA

**R** DERECHA  
DIREITA

FIJACIÓN / FIXAÇÃO

\*\* Ver página 371 para más información de cómo solicitar el toallero opcional.

\*\* Consulta a página 371 para mais informações sobre como solicitar o toalheiro opcional.

		B mm				
PERFIL BRILLO PERFIL BRILHO		200-500	501-600	601-800	801-1000	1001-1200
VIDRIO VIDRO	Transparente	275 €	315 €	388 €	444 €	500 €
	Affumicato, Bronce, Mate, Transp. decorado	330 €	378 €	466 €	533 €	600 €
	Affumicato decorado Bronce decorado Nuevos / Novos decorados *	371 €	425 €	524 €	599 €	675 €
PERFIL NEGRO MATE PERFIL PRETO MATE		PERFIL INOX MATE PERFIL INOX MATE				
VIDRIO VIDRO	Transparente	337 €	384 €	471 €	537 €	607 €
	Affumicato, Bronce, Mate, Transp. decorado	404 €	461 €	565 €	644 €	728 €
	Affumicato decorado Bronce decorado Nuevos / Novos decorados *	455 €	518 €	636 €	725 €	819 €
TOALLERO OPCIONAL PARA LATERAL ** TOALHEIRO OPCIONAL PARA LATERAL **		-	400	500	600	700
BRILLO BRILHO		-	+83 €	+94 €	+105 €	+116 €
NEGRO MATE / INOX MATE PRETO MATE / INOX MATE		-	+83 €	+94 €	+105 €	+116 €
MEDIDAS LATERAL mm		200-500	501-1200	601-1200	801-1200	1001-1200

\* Para serigrafías digitales confirmar precio con ATC. / Para serigrafias digitais confirmar preço com ATC.

### VIDRIO Y DECORADO VIDRO E DECORADO



### NUEVOS DECORADOS NOVOS DECORADOS



# suite

SS3 | MAMPARA DE DUCHA: 1 PUERTA BATIENTE Y 2 FIJOS ENTRE PAREDES  
 DIVISÓRIA DE DUCHE: 1 PORTA DE ABRIR E 2 FIXOS ENTRE PAREDE

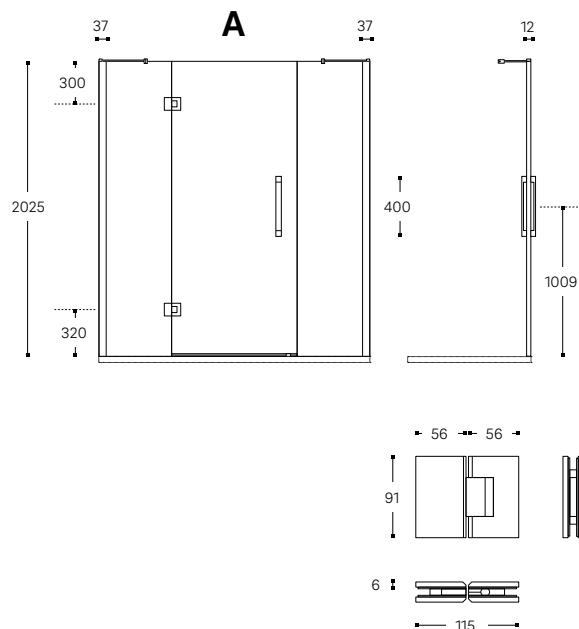

Dimensiones en mm.  
 Dimensões em mm.



VIDRIO TEMPLADO  
 VIDRO TEMPERADO  
**8 MM**



TIRADOR  
 PUXADOR  
**400-700 MM**



BISAGRAS CROMADAS  
 APERTURA **180°**  
 DOBRADIÇAS CROMADAS  
 ABERTURA **180°**



ALTURA ESTÁNDAR  
 ALTURA NORMA  
**2000 MM**  
 ALTURA ESPECIAL  
 ALTURA ESTÁNDAR  
**HASTA / ATÉ 2500 MM**



MEDIDAS Y ALTURAS ESPECIALES  
 MEDIDAS E ALTURAS ESPECIAIS  
**HASTA / ATÉ 2500 MM**  
 (VER PÁG. / CONSULTA A PÁG. **372**)



TOALLERO TIRADOR OPCIONAL  
 TOALHEIRO PUXADOR OPCIONAL  
**400-700 MM**



TRATAMIENTO INCLUIDO  
 TRATAMENTO INCLUIDO



MONTAJE  
 MONTAJEM  
**120 € \***

\* Preço recomendado  
 Código montagem **CSM10**  
 Para deslocamentos  
 consultar pág. **373**

\* Preço recomendado  
 Código montagem **CSM10**  
 Para deslocações  
 consultar pág. **373**

## ACABADOS METÁLICOS ACABAMENTOS METÁLICOS



BRILLO  
 BRILHO



NEGRO MATE  
 PRETO MATE



INOX MATE  
 INOX MATE

## TIRADOR PUXADOR



400 MM  
 500 MM  
 600 MM  
 700 MM

## TOALLERO-TIRADOR TOALHEIRO-PUXADOR

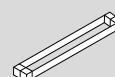

400 MM  
 500 MM  
 600 MM  
 700 MM

## SS3 | FRONTAL

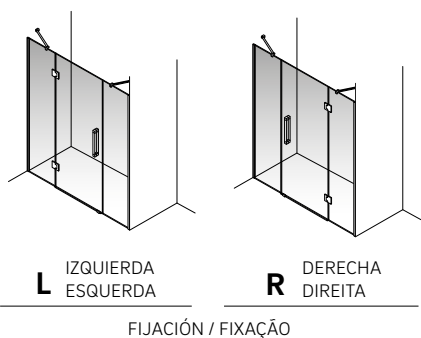

		A mm			
		1200-1400	1401-1600	1601-1900	2001-2200
<b>PERFIL BRILLO</b> <b>PERFIL BRILHO</b>					
	Transparente	1.088 €	1.117 €	1.162 €	1.257 €
VIDRIO VIDRO	Affumicato, Bronce, Mate, Transp. decorado	1.306 €	1.340 €	1.394 €	1.508 €
	Affumicato decorado Bronce decorado Nuevos / Novos decorados *	1.469 €	1.508 €	1.569 €	1.697 €
<b>PERFIL NEGRO MATE</b> <b>PERFIL PRETO MATE</b>	<b>PERFIL INOX MATE</b> <b>PERFIL INOX MATE</b>				
	Transparente	1.320 €	1.349 €	1.408 €	1.520 €
VIDRIO VIDRO	Affumicato, Bronce, Mate, Transp. decorado	1.584 €	1.619 €	1.690 €	1.824 €
	Affumicato decorado Bronce decorado Nuevos / Novos decorados *	1.782 €	1.821 €	1.901 €	2.052 €
ENTRADA MÍNIMA mm / ENTRADA MÍNIMO mm		500	600	700	800

<b>TIRADOR PARA PUERTA mm</b> <b>PUXADOR PARA PORTA mm</b>		<b>400</b>	<b>500</b>	<b>600</b>	<b>700</b>
BRILLO BRILHO	Incluido / Incluso		+17 €	+33 €	+50 €
NEGRO MATE / INOX MATE PRETO MATE / INOX MATE	Incluido / Incluso		+17 €	+33 €	+50 €
<b>TOALLERO/TIRADOR OPCIONAL PARA LA PUERTA</b> <b>TOALHEIRO/PUXADOR OPCIONAL PARA PORTA</b>					
		<b>400</b>	<b>500</b>	<b>600</b>	<b>700</b>
BRILLO BRILHO		+11 €	+28 €	+44 €	+61 €
NEGRO MATE / INOX MATE PRETO MATE / INOX MATE		+11 €	+28 €	+44 €	+61 €
MÁX. TOALLERO/TIRADOR mm MÁX. TOALHEIRO/PUXADOR mm		1200-2200	1401-2200	1601-2200	2001-2200
<b>TOALLERO OPCIONAL**</b> <b>TOALHEIRO OPCIONAL**</b>			<b>400</b>		<b>500</b>
BRILLO BRILHO		-	+83 €		+94 €
NEGRO MATE / INOX MATE PRETO MATE / INOX MATE		-	+83 €		+94 €
MÁX. TOALLERO/TIRADOR mm MÁX. TOALHEIRO/PUXADOR mm		1200-1600	1601-2200		2001-2200

Estos precios incluyen un tirador de 400mm en el mismo acabado que el perfil de la mampara.

Estos valores incluyen um puxador de 400mm do mesmo acabamento do perfil da divisória.

\*\* Ver página 371 para más información de cómo solicitar el toallero opcional.

\*\* Consulta a página 371 para mais informações sobre como solicitar o toalheiro opcional.

\* Para serigrafías digitales confirmar precio con ATC. / Para serigrafias digitais confirmar preço com ATC.

### VIDRIO Y DECORADO VIDRO E DECORADO

TRANSP.	AFFUMICATO	BRONCE	MATE
SIN DECORADO	SIN DECORADO	SIN DECORADO	SIN DECORADO
PICTOR	PICTOR	PICTOR	

### NUEVOS DECORADOS NOVOS DECORADOS

SERIGRAFÍAS ESPECIALES		SERIGRAFÍAS DIGITALES	
MIRAI	WETLANDS	BAMBOO	WAVE
GRID		FOG	

# suite

SS4 | MAMPARA DE DUCHA: 2 PUERTAS BATIENTES Y 2 FIJOS ENTRE PAREDES  
 DIVISÓRIA DE DUCHE: 2 PORTAS DE ABRIR E 2 FIXOS ENTRE PAREDE

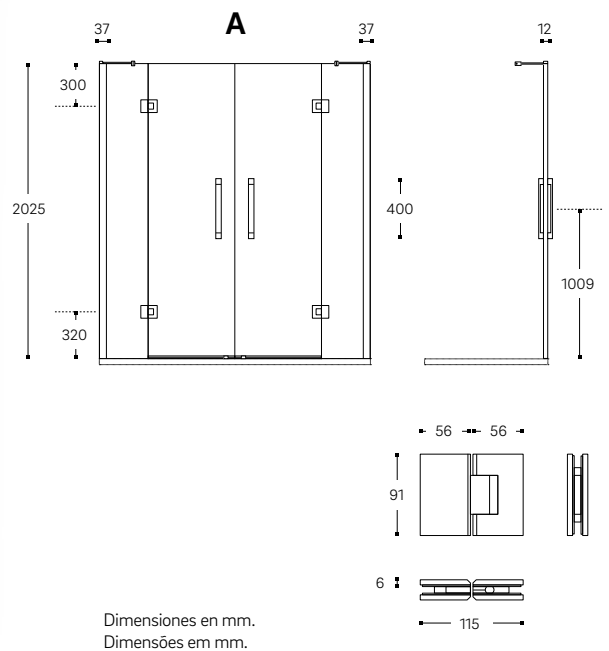

VIDRIO TEMPLADO  
 VIDRO TEMPERADO  
**8 MM**



TIRADOR  
 PUXADOR  
**400-700 MM**



BISAGRAS CROMADAS  
 APERTURA **180°**  
 DOBRADIÇAS CROMADAS  
 ABERTURA **180°**



ALTURA ESTÁNDAR  
 ALTURA NORMA  
**2000 MM**  
 ALTURA ESPECIAL  
 ALTURA ESTÁNDAR  
**HASTA / ATÉ 2500 MM**



MEDIDAS Y ALTURAS ESPECIALES  
 MEDIDAS E ALTURAS ESPECIAIS  
**HASTA / ATÉ 2500 MM**  
 (VER PÁG. / CONSULTA A PÁG. **372**)



TOALLERO TIRADOR OPCIONAL  
 TOALHEIRO PUXADOR OPCIONAL  
**400-500 MM**



TRATAMIENTO INCLUIDO  
 TRATAMENTO INCLUIDO



MONTAJE  
 MONTAJEM  
**125 € \***

\* Precio recomendado  
 Código montaje **CSM11**  
 Para desplazamientos  
 consultar pág. **373**

\* Preço recomendado  
 Código montagem **CSM11**  
 Para deslocações  
 consultar pág. **373**

## ACABADOS METÁLICOS ACABAMENTOS METÁLICOS



BRILLO  
 BRILHO



NEGRO MATE  
 PRETO MATE



INOX MATE  
 INOX MATE

## TIRADOR PUXADOR



400 MM  
 500 MM  
 600 MM  
 700 MM

## TOALLERO-TIRADOR TOALHEIRO-PUXADOR



400 MM  
 500 MM



# SS4 | FRONTAL

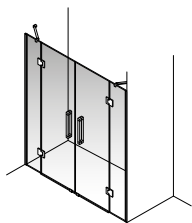

		A mm				
		1200-1400	1401-1600	1601-1800	1801-2000	2001-2200
<b>PERFIL BRILLO</b> <b>PERFIL BRILHO</b>						
VIDRIO VIDRO	Transparente	1.537 €	1.566 €	1.611 €	1.656 €	1.740 €
	Affumicato, Bronce, Mate, Transp. decorado	1.844 €	1.879 €	1.933 €	1.987 €	2.088 €
	Affumicato decorado Bronce decorado Nuevos / Novos decorados *	2.075 €	2.114 €	2.175 €	2.236 €	2.349 €
<b>PERFIL NEGRO MATE</b>   <b>PERFIL INOX MATE</b> <b>PERFIL PRETO MATE</b>   <b>PERFIL INOX MATE</b>						
VIDRIO VIDRO	Transparente	1.831 €	1.891 €	1.950 €	2.003 €	2.104 €
	Affumicato, Bronce, Mate, Transp. decorado	2.197 €	2.269 €	2.340 €	2.404 €	2.525 €
	Affumicato decorado Bronce decorado Nuevos / Novos decorados *	2.472 €	2.553 €	2.633 €	2.704 €	2.840 €
ENTRADA MÍNIMA mm / ENTRADA MÍNIMO mm		600	800	1000	1200	1200

<b>TIRADOR PARA PUERTA mm</b> <b>PUXADOR PARA PORTA mm</b>		400	500	600	700
BRILLO BRILHO	Incluido / Incluso		+33 €	+66 €	+99 €
NEGRO MATE / INOX MATE PRETO MATE / INOX MATE	Incluido / Incluso		+33 €	+66 €	+99 €
<b>TOALLERO/TIRADOR OPCIONAL</b> <b>PARA PUERTAS (2 UDS)</b> <b>TOALHEIRO/PUXADOR OPCIONAL</b> <b>PARA PORTA (2 UDS)</b>		<b>A mm</b>			
		-	400	500	600
BRILLO BRILHO		-	+22 €	+55 €	+88 €
NEGRO MATE / INOX MATE PRETO MATE / INOX MATE		-	+22 €	+55 €	+88 €
MÁX. TOALLERO/TIRADOR mm MÁX. TOALHEIRO/PUXADOR mm		1200-1600	1601-1800	1801-2000	2001-2200

Estos precios incluyen 2 tiradores de 400mm en el mismo acabado que el perfil de la mampara.  
Estos valores incluyen 2 puxadores de 400mm do mesmo acabamento do perfil da divisória.

\* Para serigrafías digitales confirmar precio con ATC. / Para serigrafias digitais confirmar preço com ATC.

## VIDRIO Y DECORADO VIDRO E DECORADO

TRANSP.	AFFUMICATO	BRONCE	MATE
SIN DECORADO	SIN DECORADO	SIN DECORADO	SIN DECORADO
PICTOR	PICTOR	PICTOR	

## NUEVOS DECORADOS NOVOS DECORADOS

SERIGRAFÍAS ESPECIALES		SERIGRAFÍAS DIGITALES	
MIRAI	WETLANDS	BAMBOO	WAVE
GRID		FOG	

# suite

SS9 | MAMPARA DE DUCHA: 2 PUERTAS BATIENTES Y 2 FIJOS MÁS LATERAL  
 DIVISÓRIA DE DUCHE: 2 PORTAS DE ABRIR E 2 FIXOS MAIS LATERAL

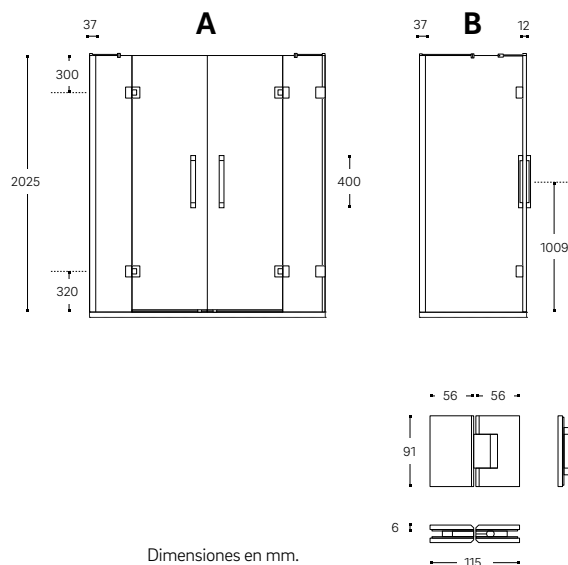

Dimensiones en mm.  
 Dimensões em mm.



VIDRIO TEMPLADO  
 VIDRO TEMPERADO  
**8 MM**



TIRADOR  
 PUXADOR  
**400-700 MM**



BISAGRAS CROMADAS  
 APERTURA **180°**  
 DOBRADIÇAS CROMADAS  
 ABERTURA **180°**



ALTURA ESTÁNDAR  
 ALTURA NORMA  
**2000 MM**  
 ALTURA ESPECIAL  
 ALTURA ESTÁNDAR  
**HASTA / ATÉ 2500 MM**



MEDIDAS Y ALTURAS ESPECIALES  
 MEDIDAS E ALTURAS ESPECIAIS  
**HASTA / ATÉ 2500 MM**  
 (VER PÁG. / CONSULTA A PÁG. **372**)



TOALLERO TIRADOR OPCIONAL  
 TOALHEIRO PUXADOR OPCIONAL  
**400-500 MM**



TRATAMIENTO INCLUIDO  
 TRATAMENTO INCLUIDO



MONTAJE  
 MONTAJEM  
**150 € \***

\* Precio recomendado  
 Código montaje **CSM16**  
 Para desplazamientos  
 consultar pág. **373**

\* Preço recomendado  
 Código montagem **CSM16**  
 Para deslocações  
 consultar pág. **373**

## ACABADOS METÁLICOS ACABAMENTOS METÁLICOS



BRILLO  
 BRILHO



NEGRO MATE  
 PRETO MATE

## TIRADOR PUXADOR



400 MM  
 500 MM  
 600 MM  
 700 MM

## TOALLERO-TIRADOR TOALHEIRO-PUXADOR

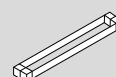

400 MM  
 500 MM

## SS9 | FRONTAL

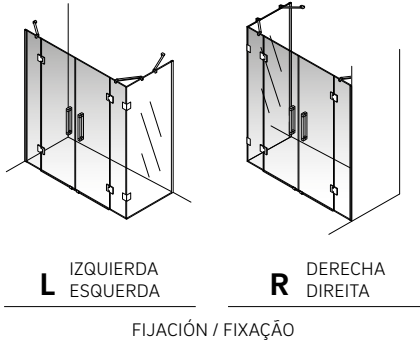

Estos precios incluyen 2 tiradores de 400mm en el mismo acabado que el perfil de la mampara.

Estos valores incluem 2 puxadores de 400mm do mesmo acabamento do perfil da divisória.

		A mm				
PERFIL BRILLO PERFIL BRILHO		1200-1400	1401-1600	1601-1800	1801-2000	2001-2200
	Transparente	1.537 €	1.566 €	1.611 €	1.656 €	1.740 €
VIDRIO VIDRO	Affumicato, Bronce, Mate, Transp. decorado	1.844 €	1.879 €	1.933 €	1.987 €	2.088 €
	Affumicato decorado Bronce decorado Nuevos / Novos decorados *	2.075 €	2.114 €	2.175 €	2.236 €	2.349 €
PERFIL NEGRO MATE PERFIL PRETO MATE						
	Transparente	1.863 €	1.891 €	1.950 €	2.003 €	2.104 €
VIDRIO VIDRO	Affumicato, Bronce, Mate, Transp. decorado	2.236 €	2.269 €	2.340 €	2.404 €	2.525 €
	Affumicato decorado Bronce decorado Nuevos / Novos decorados *	2.515 €	2.553 €	2.633 €	2.704 €	2.840 €
ENTRADA MÍNIMA mm / ENTRADA MÍNIMO mm		600	800	1000	1200	1200

TIRADOR PARA PUERTA mm PUXADOR PARA PORTA mm	400	500	600	700
BRILLO BRILHO	Incluido / Incluso	+33 €	+66 €	+99 €
NEGRO MATE PRETO MATE	Incluido / Incluso	+33 €	+66 €	+99 €
TOALLERO/TIRADOR OPCIONAL PARA PUERTAS (2 UDS) TOALHEIRO/PUXADOR OPCIONAL PARA PORTA (2 UDS)	A mm			
	-	400	500	600
BRILLO BRILHO	-	+22 €	+55 €	+88 €
NEGRO MATE PRETO MATE	-	+22 €	+55 €	+88 €
MÁX. TOALLERO/TIRADOR mm MÁX. TOALHEIRO/PUXADOR mm	1200-1600	1601-1800	1801-2000	2001-2200

## SLS | LATERAL

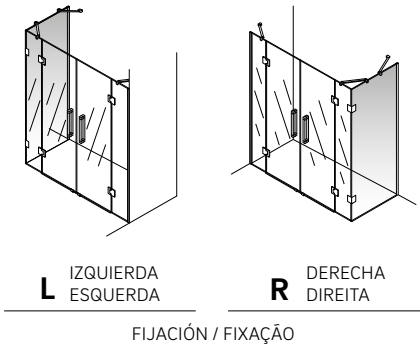

\*\* Ver página 371 para más información de cómo solicitar el toallero opcional.

\*\* Consulta a página 371 para mais informações sobre como solicitar o toalheiro opcional.

		B mm				
PERFIL BRILLO PERFIL BRILHO		200-500	501-600	601-800	801-1000	1001-1200
	Transparente	410 €	433 €	478 €	534 €	590 €
VIDRIO VIDRO	Affumicato, Bronce, Mate, Transp. decorado	492 €	520 €	574 €	641 €	708 €
	Affumicato decorado Bronce decorado Nuevos / Novos decorados *	554 €	585 €	645 €	721 €	797 €
NEGRO MATE PRETO MATE						
	Transparente	495 €	525 €	578 €	649 €	713 €
VIDRIO VIDRO	Affumicato, Bronce, Mate, Transp. decorado	594 €	630 €	694 €	779 €	856 €
	Affumicato decorado Bronce decorado Nuevos / Novos decorados *	668 €	709 €	780 €	876 €	963 €
TOALLERO OPCIONAL PARA LATERAL ** TOALHEIRO OPCIONAL PARA LATERAL **	-	400	500	600	700	
BRILLO BRILHO	-	+83 €	+94 €	+105 €	+116 €	
NEGRO MATE PRETO MATE	-	+83 €	+94 €	+105 €	+116 €	
MEDIDAS LATERAL mm	200-500	501-1200	601-1200	801-2000	1001-1200	

\* Para serigrafías digitales confirmar precio con ATC. / Para serigrafias digitais confirmar preço com ATC.

### VIDRIO Y DECORADO VIDRO E DECORADO



### NUEVOS DECORADOS NOVOS DECORADOS



PS2 | MAMPARA DE DUCHA: 1 PUERTA BATIENTE Y 1 FIJO ENTRE PAREDES  
 DIVISÓRIA DE DUCHE: 1 PORTA DE ABRIR E 1 FIXO ENTRE PAREDE

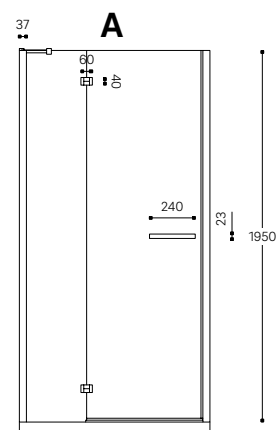

Dimensiones en mm.  
 Dimensões em mm.



VIDRIO TEMPLADO  
 VIDRO TEMPERADO  
**6 MM**



COMPENSACIÓN  
 COMPENSAÇÃO  
**15 MM**

\*15 mm en eje y  
 10 mm en cierre  
 \*15 mm em eixo e  
 10 mm em cerramento



ALTURA MODELO DUCHA  
 ALTURA MODELO DUCHE  
**1950 MM**



APERTURA 90°  
 ABERTURA 90°



MEDIDAS Y ALTURAS ESPECIALES  
 MEDIDAS E ALTURAS ESPECIAIS  
 (VER PÁG. / CONSULTA A PÁG. **372**)



TRATAMIENTO OPCIONAL (M)  
 TRATAMENTO OPCIONAL (M)  
**65 €**



MONTAJE  
 MONTAJEM  
**95 € \***

\* Precio recomendado  
 Código montaje **CSM05**  
 Para desplazamientos  
 consultar pág. **373**  
 \* Preço recomendado  
 Código montagem **CSM05**  
 Para deslocações  
 consultar pág. **373**

## ACABADOS METÁLICOS ACABAMENTOS METÁLICOS



BLANCO  
 BRANCO



PLATA BRILLO  
 PRATA BRILHO



PLATA MATE  
 PRATA MATE

# PS2 | FRONTAL

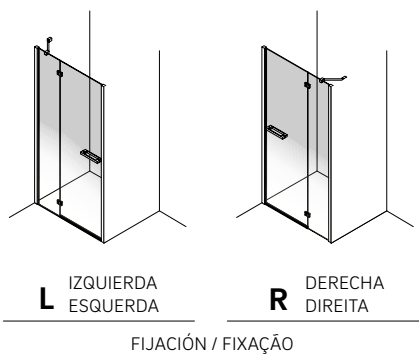

		A mm	
PERFIL BLANCO - PLATA BRILLO - PLATA MATE PERFIL BRANCO - PRATA BRILHO - PRATA MATE		800-900	901-1300
VIDRIO VIDRO	Transparente	599 €	637 €
	Affumicato, Bronce, Mate, Transp. decorado	749 €	796 €
	Affumicato decorado Bronce decorado Nuevos / Novos decorados *	839 €	892 €
ENTRADA MÍNIMA mm / ENTRADA MÍNIMO mm		500	600

\* Para serigrafías digitales confirmar precio con ATC. / Para serigrafias digitais confirmar preço com ATC.

## VIDRIO Y DECORADO VIDRO E DECORADO



## NUEVOS DECORADOS NOVOS DECORADOS



PS7 | MAMPARA DE DUCHA: 1 PUERTA BATIENTE Y 1 FIJO MÁS LATERAL  
 DIVISÓRIA DE DUCHE: 1 PORTA DE ABRIR E 1 FIXO MAIS LATERAL

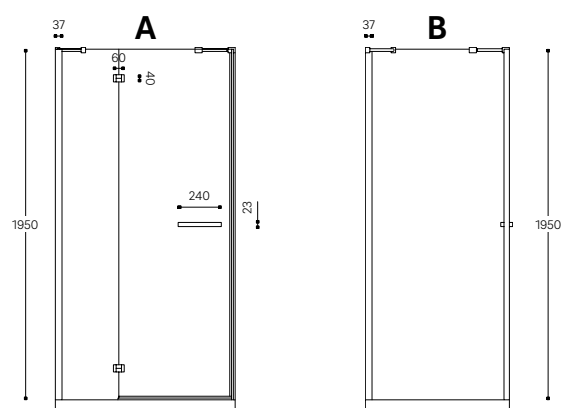

Dimensiones en mm.  
 Dimensões em mm.



VIDRIO TEMPLADO  
 VIDRO TEMPERADO  
**6 MM**



COMPENSACIÓN FRONTAL Y LATERAL  
 COMPENSAÇÃO FRONTAL E LATERAL  
**15 MM \***



ALTURA MODELO DUCHA  
 ALTURA MODELO DUCHE  
**1950 MM**



APERTURA 90°  
 ABERTURA 90°



MEDIDAS Y ALTURAS ESPECIALES  
 MEDIDAS E ALTURAS ESPECIAIS  
 (VER PÁG. / CONSULTA A PÁG. **372**)



LATERALES REVERSIBLES  
 LATERALS REVERSÍVEIS



TRATAMIENTO OPCIONAL (M)  
 TRATAMENTO OPCIONAL (M)  
 FRONTAL **65 €** - LATERAL **35 €**



MONTAJE  
 MONTAJEM  
**120 € \***

\* Precio recomendado  
 Código montaje **CSM10**  
 Para desplazamientos  
 consultar pág. **373**

\* Preço recomendado  
 Código montagem **CSM10**  
 Para deslocações  
 consultar pág. **373**

## ACABADOS METÁLICOS ACABAMENTOS METÁLICOS



BLANCO  
 BRANCO



PLATA BRILLO  
 PRATA BRILHO



PLATA MATE  
 PRATA MATE

## PS7 | FRONTAL

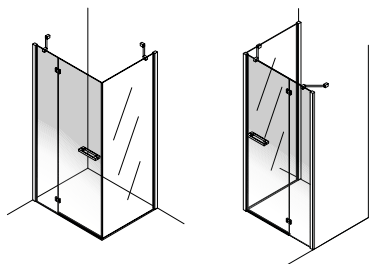

**L** IZQUIERDA  
ESQUERDA

**R** DERECHA  
DIREITA

FIJACIÓN / FIXAÇÃO

		A mm	
PERFIL BLANCO - PLATA BRILLO - PLATA MATE PERFIL BRANCO - PRATA BRILHO - PRATA MATE		800-900	901-1300
VIDRIO VIDRO	Transparente	599 €	637 €
	Affumicato, Bronce, Mate, Transp. decorado	749 €	796 €
	Affumicato decorado Bronce decorado Nuevos / Novos decorados *	839 €	892 €
ENTRADA MÍNIMA mm / ENTRADA MÍNIMO mm		500	600

## PLB | LATERAL

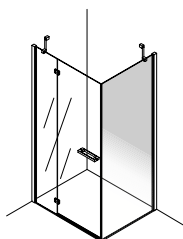

		B mm			
PERFIL BLANCO - PLATA BRILLO - PLATA MATE PERFIL BRANCO - PRATA BRILHO - PRATA MATE		200-400	401-600	601-800	801-1000
VIDRIO VIDRO	Transparente	225 €	247 €	276 €	302 €
	Affumicato, Bronce, Mate, Transp. decorado	281 €	309 €	345 €	378 €
	Affumicato decorado Bronce decorado Nuevos / Novos decorados *	315 €	346 €	386 €	423 €

\* Para serigrafías digitales confirmar precio con ATC. / Para serigrafias digitais confirmar preço com ATC.

### VIDRIO Y DECORADO VIDRO E DECORADO

TRANSP.



SIN DECORADO



PICTOR

AFFUMICATO



SIN DECORADO



PICTOR

BRONCE



SIN DECORADO



PICTOR

MATE



SIN DECORADO

### NUEVOS DECORADOS NOVOS DECORADOS

SERIGRAFIAS ESPECIALES



MIRAI



WETLANDS



GRID

SERIGRAFIAS DIGITALES



BAMBOO



WAVE



FOG

PSS | MAMPARA DE DUCHA: 1 PUERTA BATIENTE MÁS LATERAL  
 DIVISÓRIA DE DUCHE: 1 PORTA DE ABRIR E 1 MAIS LATERAL

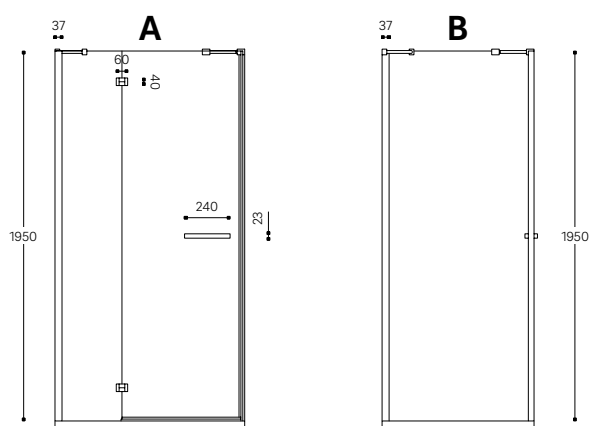

Dimensiones en mm.  
 Dimensões em mm.



VIDRIO TEMPLADO  
 VIDRO TEMPERADO  
**6 MM**



COMPENSACIÓN FRONTAL Y LATERAL  
 COMPENSAÇÃO FRONTAL E LATERAL  
**15 MM \***

\*15 mm en eje y  
 10 mm en cierre  
 \*15 mm em eixo e  
 10 mm em cerramento

Compensación  
 15mm en lateral  
 Compensação  
 15mm en lateral



ALTURA MODELO DUCHA  
 ALTURA MODELO DUCHE  
**1950 MM**



APERTURA 90°  
 ABERTURA 90°



MEDIDAS Y ALTURAS ESPECIALES  
 MEDIDAS E ALTURAS ESPECIAIS  
 (VER PÁG. / CONSULTA A PÁG. **372**)



TRATAMIENTO OPCIONAL (M)  
 TRATAMENTO OPCIONAL (M)  
 FRONTAL **65 €** - LATERAL **35 €**



LATERALES REVERSIBLES  
 LATERALS REVERSÍVELS



MONTAJE  
 MONTAJEM  
**120 € \***

\* Precio recomendado  
 Código montaje **CSM10**  
 Para desplazamientos  
 consultar pág. **373**

\* Preço recomendado  
 Código montagem **CSM10**  
 Para deslocações  
 consultar pág. **373**

## ACABADOS METÁLICOS ACABAMENTOS METÁLICOS



BLANCO  
 BRANCO



PLATA BRILLO  
 PRATA BRILHO



PLATA MATE  
 PRATA MATE



## PSS | FRONTAL

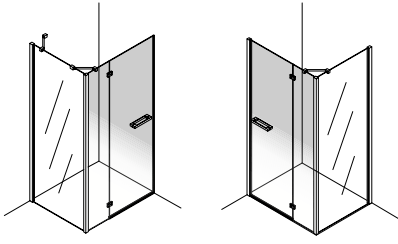

**L** IZQUIERDA  
ESQUERDA

**R** DERECHA  
DIREITA

FIJACIÓN / FIXAÇÃO

		A mm	
PERFIL BLANCO - PLATA BRILLO - PLATA MATE PERFIL BRANCO - PRATA BRILHO - PRATA MATE		800-900	901-1300
VIDRIO VIDRO	Transparente	599 €	637 €
	Affumicato, Bronce, Mate, Transp. decorado	749 €	796 €
	Affumicato decorado Bronce decorado Nuevos / Novos decorados *	839 €	892 €
ENTRADA MÍNIMA mm / ENTRADA MÍNIMO mm		500	600

## PLF | LATERAL

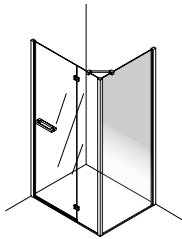

		B mm			
PERFIL BLANCO - PLATA BRILLO - PLATA MATE PERFIL BRANCO - PRATA BRILHO - PRATA MATE		200-400	401-600	601-800	801-1000
VIDRIO VIDRO	Transparente	198 €	225 €	254 €	280 €
	Affumicato, Bronce, Mate, Transp. decorado	248 €	281 €	318 €	350 €
	Affumicato decorado Bronce decorado Nuevos / Novos decorados *	277 €	315 €	356 €	392 €

\* Para serigrafías digitales confirmar precio con ATC. / Para serigrafias digitais confirmar preço com ATC.

### VIDRIO Y DECORADO VIDRO E DECORADO

TRANSP.	AFFUMICATO	BRONCE	MATE
SIN DECORADO	SIN DECORADO	SIN DECORADO	SIN DECORADO
PICTOR	PICTOR	PICTOR	

### NUEVOS DECORADOS NOVOS DECORADOS

SERIGRAFÍAS ESPECIALES		SERIGRAFÍAS DIGITALES	
MIRAI	WETLANDS	BAMBOO	WAVE
GRID		FOG	

PS3 | MAMPARA DE DUCHA: 1 PUERTA BATIENTE Y 2 FIJOS ENTRE PAREDES  
 DIVISÓRIA DE DUCHE: 1 PORTA DE ABRIR E 2 FIXOS ENTRE PAREDE

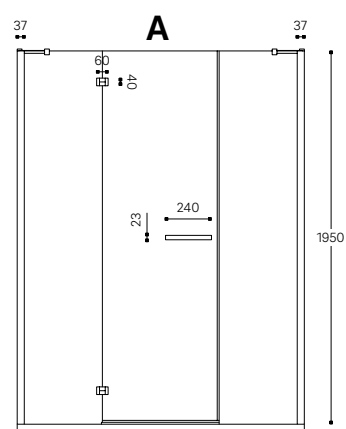

Dimensiones en mm.  
 Dimensões em mm.



VIDRIO TEMPLADO  
 VIDRO TEMPERADO  
**6 MM**



COMPENSACIÓN A CADA LADO  
 COMPENSAÇÃO EM CADA LADO  
**15 MM**



ALTURA MODELO DUCHA  
 ALTURA MODELO DUCHE  
**1950 MM**



APERTURA 90°  
 ABERTURA 90°



MEDIDAS Y ALTURAS ESPECIALES  
 MEDIDAS E ALTURAS ESPECIAIS  
 (VER PÁG. / CONSULTA A PÁG. **372**)



TRATAMIENTO OPCIONAL (M)  
 TRATAMENTO OPCIONAL (M)  
**85 €**



PARA MEDIDA SUPERIOR A 1400MM  
 EL TIRANTE VA A PARED CONTRARIA  
 PARA MEDIDAS MAIORES A 1400MM  
 LA BARRA PARA PAREDE OPOSTA



MONTAJE  
 MONTAJEM  
**100 € \***

\* Precio recomendado  
 Código montaje **CSM06**  
 Para desplazamientos  
 consultar pág. **373**

\* Preço recomendado  
 Código montagem **CSM06**  
 Para deslocações  
 consultar pág. **373**

## ACABADOS METÁLICOS ACABAMENTOS METÁLICOS



BLANCO  
 BRANCO



PLATA BRILLO  
 PRATA BRILHO



PLATA MATE  
 PRATA MATE

# PS3 | FRONTAL

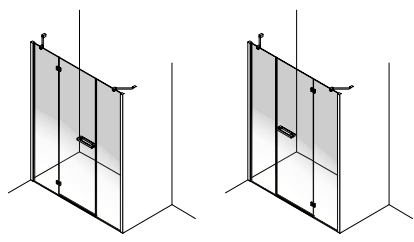

**L** IZQUIERDA  
ESQUERDA

**R** DERECHA  
DIREITA

FIJACIÓN / FIXAÇÃO

PERFIL BLANCO - PLATA BRILLO - PLATA MATE PERFIL BRANCO - PRATA BRILHO - PRATA MATE		A mm		
		1000-1200	1201-1500	1501-1800
VIDRIO VIDRO	Transparente	818 €	856 €	895 €
	Affumicato, Bronce, Mate, Transp. decorado	1.023 €	1.070 €	1.119 €
	Affumicato decorado Bronce decorado Nuevos / Novos decorados *	1.145 €	1.198 €	1.253 €
ENTRADA MÍNIMA mm / ENTRADA MÍNIMO mm		500	600	600

\* Para serigrafías digitales confirmar precio con ATC. / Para serigrafias digitais confirmar preço com ATC.

## VIDRIO Y DECORADO VIDRO E DECORADO

TRANSP.



SIN DECORADO



PICTOR

AFFUMICATO



SIN DECORADO



PICTOR

BRONCE



SIN DECORADO



PICTOR

MATE



SIN DECORADO

## NUEVOS DECORADOS NOVOS DECORADOS

SERIGRAFÍAS ESPECIALES



MIRAI



WETLANDS



GRID

SERIGRAFÍAS DIGITALES



BAMBOO



WAVE



FOG

PS8 | MAMPARA DE DUCHA: 1 PUERTA BATIENTE Y 1 FIJO MÁS LATERAL  
 DIVISÓRIA DE DUCHE: 1 PORTA DE ABRIR E 1 FIXO MAIS LATERAL

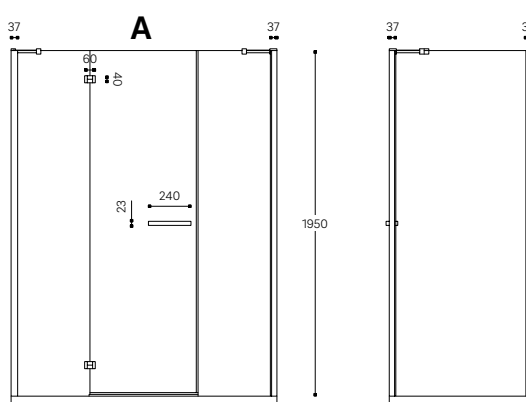

Dimensiones en mm.  
 Dimensões em mm.



VIDRIO TEMPLADO  
 VIDRO TEMPERADO  
**6 MM**



COMPENSACIÓN A CADA LADO  
 COMPENSAÇÃO EM CADA LADO  
**15 MM**



ALTURA MODELO DUCHA  
 ALTURA MODELO DUCHE  
**1950 MM**



APERTURA 90°  
 ABERTURA 90°



MEDIDAS Y ALTURAS ESPECIALES  
 MEDIDAS E ALTURAS ESPECIAIS  
 (VER PÁG. / CONSULTA A PÁG. **372**)



LATERALES REVERSIBLES  
 LATERALS REVERSÍVEIS



TRATAMIENTO OPCIONAL (M)  
 TRATAMENTO OPCIONAL (M)  
 FRONTAL **85 €** - LATERAL **35 €**



MONTAJE  
 MONTAJEM  
**125 € \***

\* Precio recomendado  
 Código montaje **CSM11**  
 Para desplazamientos  
 consultar pág. **373**

\* Preço recomendado  
 Código montagem **CSM11**  
 Para deslocações  
 consultar pág. **373**

## ACABADOS METÁLICOS ACABAMENTOS METÁLICOS



BLANCO  
 BRANCO



PLATA BRILLO  
 PRATA BRILHO



PLATA MATE  
 PRATA MATE

## PS8 | FRONTAL

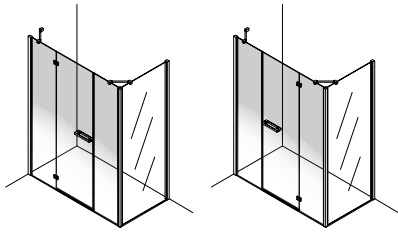

**L** IZQUIERDA  
ESQUERDA

**R** DERECHA  
DIREITA

FIJACIÓN / FIXAÇÃO

PERFIL BLANCO - PLATA BRILLO - PLATA MATE PERFIL BRANCO - PRATA BRILHO - PRATA MATE		A mm		
		1000-1200	1201-1500	1501-1800
VIDRIO VIDRO	Transparente	818 €	856 €	895 €
	Affumicato, Bronce, Mate, Transp. decorado	1.023 €	1.070 €	1.119 €
	Affumicato decorado Bronce decorado Nuevos / Novos decorados *	1.145 €	1.198 €	1.253 €
ENTRADA MÍNIMA mm / ENTRADA MÍNIMO mm		500	600	600

## PLF | LATERAL

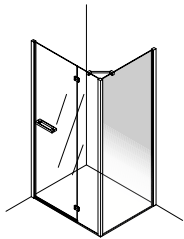

PERFIL BLANCO - PLATA BRILLO - PLATA MATE PERFIL BRANCO - PRATA BRILHO - PRATA MATE		B mm			
		200-400	401-600	601-800	801-1000
VIDRIO VIDRO	Transparente	198 €	225 €	254 €	280 €
	Affumicato, Bronce, Mate, Transp. decorado	248 €	281 €	318 €	350 €
	Affumicato decorado Bronce decorado Nuevos / Novos decorados *	277 €	315 €	356 €	392 €

\* Para serigrafías digitales confirmar precio con ATC. / Para serigrafias digitais confirmar preço com ATC.

### VIDRIO Y DECORADO VIDRO E DECORADO

TRANSP.	AFFUMICATO	BRONCE	MATE
SIN DECORADO	SIN DECORADO	SIN DECORADO	SIN DECORADO
PICTOR	PICTOR	PICTOR	

### NUEVOS DECORADOS NOVOS DECORADOS

SERIGRAFÍAS ESPECIALES		SERIGRAFÍAS DIGITALES	
MIRAI	WETLANDS	BAMBOO	WAVE
GRID		FOG	

PS4 | MAMPARA DE DUCHA: 2 PUERTAS BATIENTES Y 2 FIJOS ENTRE PAREDES  
 DIVISÓRIA DE DUCHE: 2 PORTAS DE ABRIR E 2 FIXOS ENTRE PAREDE

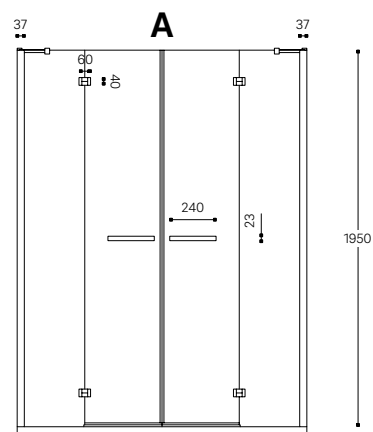

Dimensiones en mm.  
 Dimensões em mm.



VIDRIO TEMPLADO  
 VIDRO TEMPERADO  
**6 MM**



COMPENSACIÓN A CADA LADO  
 COMPENSAÇÃO EM CADA LADO  
**15 MM**



ALTURA MODELO DUCHA  
 ALTURA MODELO DUCHE  
**1950 MM**



APERTURA 90°  
 ABERTURA 90°



MEDIDAS Y ALTURAS ESPECIALES  
 MEDIDAS E ALTURAS ESPECIAIS  
 (VER PÁG. / CONSULTA A PÁG. **372**)



REVERSIBLE  
 REVERSÍVEL



TRATAMIENTO OPCIONAL (M)  
 TRATAMENTO OPCIONAL (M)  
**95 €**



MONTAJE  
 MONTAJEM  
**105 € \***

\* Precio recomendado  
 Código montaje **CSM07**  
 Para desplazamientos y alturas especiales consultar pág. **373**

\* Preço recomendado  
 Código montagem **CSM07**  
 Para deslocações e alturas especiais consultar pág. **373**

## ACABADOS METÁLICOS ACABAMENTOS METÁLICOS



BLANCO  
 BRANCO



PLATA BRILLO  
 PRATA BRILHO



PLATA MATE  
 PRATA MATE

# PS4 | FRONTAL

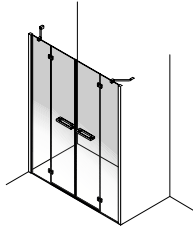

		A mm			
PERFIL BLANCO - PLATA BRILLO - PLATA MATE PERFIL BRANCO - PRATA BRILHO - PRATA MATE		1100-1300	1301-1500	1501-1800	1801-2200
VIDRIO VIDRO	Transparente	917 €	956 €	999 €	1.043 €
	Affumicato, Bronce, Mate, Transp. decorado	1.146 €	1.195 €	1.249 €	1.304 €
	Affumicato decorado Bronce decorado Nuevos / Novos decorados *	1.284 €	1.338 €	1.399 €	1.460 €
ENTRADA MÍNIMA mm / ENTRADA MÍNIMO mm		600	800	1000	1200

\* Para serigrafías digitales confirmar precio con ATC. / Para serigrafias digitais confirmar preço com ATC.

## VIDRIO Y DECORADO VIDRO E DECORADO



## NUEVOS DECORADOS NOVOS DECORADOS



PS9 | FRONTAL DE DUCHA: 2 PUERTAS BATIENTES Y 2 FIJOS MÁS LATERAL  
 DIVISÓRIA DE DUCHE: 2 PORTAS DE ABRIR E 2 FIXOS MAIS LATERAL

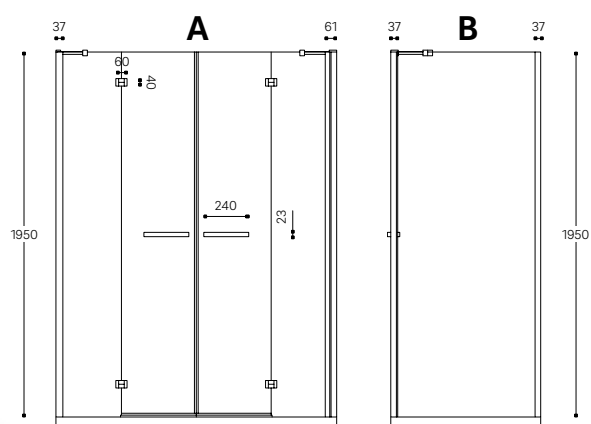

Dimensiones en mm.  
 Dimensões em mm.



VIDRIO TEMPLADO  
 VIDRO TEMPERADO  
**6 MM**



COMPENSACIÓN A CADA LADO EN  
 FRONTAL Y LATERAL  
 COMPENSAÇÃO EM CADA LADO  
 EM FRONTAL E LATERAL  
**15 MM**



ALTURA MODELO DUCHA  
 ALTURA MODELO DUCHE  
**1950 MM**



APERTURA 90°  
 ABERTURA 90°



MEDIDAS Y ALTURAS ESPECIALES  
 MEDIDAS E ALTURAS ESPECIAIS  
 (VER PÁG. / CONSULTA A PÁG. **372**)



LATERAL REVERSIBLE  
 LATERAL REVERSÍVEL



TRATAMIENTO OPCIONAL (M)  
 TRATAMENTO OPCIONAL (M)  
 FRONTAL **95 €** - LATERAL **35 €**



MONTAJE  
 MONTAJEM  
**125 € \***

\* Precio recomendado  
 Código montaje **CSM11**  
 Para desplazamientos y alturas  
 especiales consultar pág. **373**

\* Preço recomendado  
 Código montagem **CSM11**  
 Para deslocações e alturas especiais  
 consultar pág. **373**

## ACABADOS METÁLICOS ACABAMENTOS METÁLICOS



BLANCO  
 BRANCO



PLATA BRILLO  
 PRATA BRILHO



PLATA MATE  
 PRATA MATE



## PS9 | FRONTAL

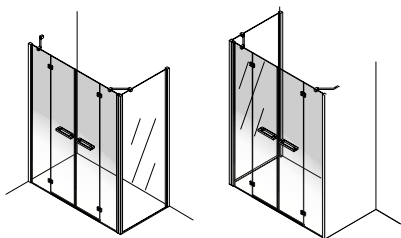

**L** IZQUIERDA  
ESQUERDA

**R** DERECHA  
DIREITA

FIJACIÓN / FIXAÇÃO

		A mm			
PERFIL BLANCO - PLATA BRILLO - PLATA MATE PERFIL BRANCO - PRATA BRILHO - PRATA MATE		1100-1300	1301-1500	1501-1800	1801-2200
VIDRIO VIDRO	Transparente	917 €	956 €	999 €	1.043 €
	Affumicato, Bronce, Mate, Transp. decorado	1.146 €	1.195 €	1.249 €	1.304 €
	Affumicato decorado Bronce decorado Nuevos / Novos decorados *	1.284 €	1.338 €	1.399 €	1.460 €
ENTRADA MÍNIMA mm / ENTRADA MÍNIMO mm		600	800	1000	1200

## PLF | LATERAL

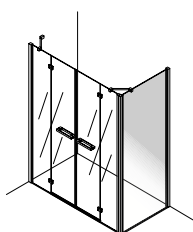

		B mm			
PERFIL BLANCO - PLATA BRILLO - PLATA MATE PERFIL BRANCO - PRATA BRILHO - PRATA MATE		200-400	401-600	601-800	801-1000
VIDRIO VIDRO	Transparente	198 €	225 €	254 €	280 €
	Affumicato, Bronce, Mate, Transp. decorado	248 €	281 €	318 €	350 €
	Affumicato decorado Bronce decorado Nuevos / Novos decorados *	277 €	315 €	356 €	392 €

\* Para serigrafías digitales confirmar precio con ATC. / Para serigrafias digitais confirmar preço com ATC.

### VIDRIO Y DECORADO VIDRO E DECORADO

TRANSP.



SIN DECORADO



PICTOR

AFFUMICATO



SIN DECORADO



PICTOR

BRONCE



SIN DECORADO



PICTOR

MATE



SIN DECORADO

### NUEVOS DECORADOS NOVOS DECORADOS

SERIGRAFÍAS ESPECIALES



MIRAI



WETLANDS



GRID

SERIGRAFÍAS DIGITALES



BAMBOO



WAVE



FOG

PS5 | MAMPARA ANGULAR: 2 PUERTAS BATIENTES Y 2 FIJOS  
 DIVISÓRIA ANGULAR: 2 PORTAS DE ABRIR E 2 FIXOS

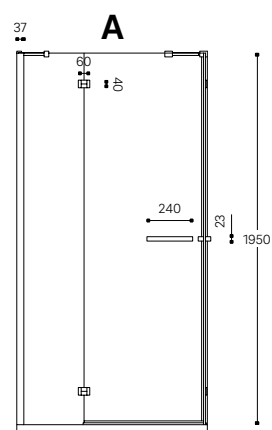

Dimensiones en mm.  
 Dimensões em mm.



VIDRIO TEMPLADO  
 VIDRO TEMPERADO  
**6 MM**



COMPENSAÇÃO A CADA LADO  
 COMPENSAÇÃO EM CADA LADO  
**15 MM**



ALTURA MODELO DUCHA  
 ALTURA MODELO DUCHE  
**1950 MM**



APERTURA 90°  
 ABERTURA 90°



MEDIDAS Y ALTURAS ESPECIALES  
 MEDIDAS E ALTURAS ESPECIAIS  
 (VER PÁG. / CONSULTA A PÁG. **372**)



TRATAMIENTO OPCIONAL (M)  
 TRATAMENTO OPCIONAL (M)  
**47,50 €**



MONTAJE  
 MONTAJEM  
**125 € \***

\* Precio recomendado  
 Código montaje **CSM11**  
 Para desplazamientos y alturas especiales consultar pág. **373**

\* Preço recomendado  
 Código montagem **CSM11**  
 Para deslocações e alturas especiais consultar pág. **373**

## ACABADOS METÁLICOS ACABAMENTOS METÁLICOS



BLANCO  
 BRANCO



PLATA BRILLO  
 PRATA BRILHO



PLATA MATE  
 PRATA MATE

PS5

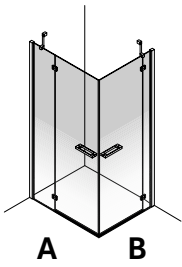

		<b>A mm</b>	
<b>PERFIL BLANCO - PLATA BRILLO - PLATA MATE</b> <b>PERFIL BRANCO - PRATA BRILHO - PRATA MATE</b>		<b>800-900</b>	<b>901-1300</b>
VIDRIO VIDRO	Transparente	478 €	511 €
	Affumicato, Bronce, Mate, Transp. decorado	598 €	639 €
	Affumicato decorado Bronce decorado Nuevos / Novos decorados *	669 €	715 €
MEDIDA PUERTA IZQUIERDA / PORTA ESQUERDA mm		500	500
MEDIDA PUERTA DEREITA 7 PORTA DIREITA mm		500	600

		<b>B mm</b>	
<b>PERFIL BLANCO - PLATA BRILLO - PLATA MATE</b> <b>PERFIL BRANCO - PRATA BRILHO - PRATA MATE</b>		<b>800-900</b>	<b>901-1300</b>
VIDRIO VIDRO	Transparente	478 €	511 €
	Affumicato, Bronce, Mate, Transp. decorado	598 €	639 €
	Affumicato decorado Bronce decorado Nuevos / Novos decorados *	669 €	715 €
MEDIDA PUERTA IZQUIERDA / PORTA ESQUERDA mm		500	500
MEDIDA PUERTA DEREITA 7 PORTA DIREITA mm		500	600

Para precio total, sumar ambos lados A y B.  
Para o preço total, some os dois lados A e B.

Stock

Info

\* Para serigrafías digitales confirmar precio con ATC. / Para serigrafias digitais confirmar preço com ATC.

**VIDRIO Y DECORADO**  
**VIDRO E DECORADO**



**NUEVOS DECORADOS**  
**NOVOS DECORADOS**



# technic

TS1 | MAMPARA DE DUCHA: 1 PUERTA BATIENTE ENTRE PAREDES  
 DIVISÓRIA DE DUCHE: 1 PORTA DE ABRIR ENTRE PAREDE

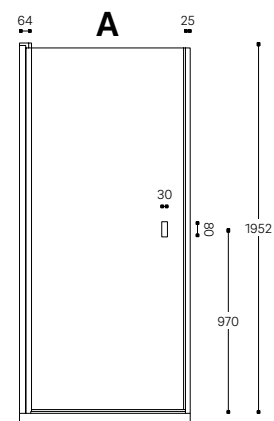

Dimensiones en mm.  
 Dimensões em mm.



VIDRIO TEMPLADO  
 VIDRO TEMPERADO  
**6 MM**



COMPENSAÇÃO  
 COMPENSAÇÃO  
**25 MM**



ALTURA MODELO DUCHA  
 ALTURA MODELO DUCHE  
**1950 MM**



REVERSIBLE  
 REVERSÍVEL



APERTURA  
 ABERTURA  
**180°**



MEDIDAS Y ALTURAS ESPECIALES  
 MEDIDAS E ALTURAS ESPECIAIS  
 (VER PÁG. / CONSULTA A PÁG. **372**)



UP&DOWN  
 UP&DOWN



TRATAMIENTO OPCIONAL (M)  
 TRATAMENTO OPCIONAL (M)  
**55 €**



Apto para adaptar a personas con movilidad reducida (bajo pedido)  
 Adequado para acomodar as pessoas com mobilidade reduzida (a pedido)  
**+ 20% S/PVP**



MONTAJE  
 MONTAJEM  
**85 € \***

\* Precio recomendado  
 Código montaje **CSM03**  
 Para desplazamientos  
 consultar pág. **373**

\* Preço recomendado  
 Código montagem **CSM03**  
 Para deslocações  
 consultar pág. **373**

## ACABADOS METÁLICOS ACABAMENTOS METÁLICOS



BLANCO  
 BRANCO



PLATA BRILLO  
 PRATA BRILHO



PLATA MATE  
 PRATA MATE

# TS1 | FRONTAL

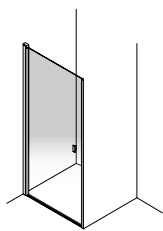

		<b>A mm</b>	
<b>PERFIL BLANCO - PLATA BRILLO - PLATA MATE</b> <b>PERFIL BRANCO - PRATA BRILHO - PRATA MATE</b>		<b>700-800</b>	<b>801-1000</b>
VIDRIO VIDRO	Transparente	486 €	526 €
	Affumicato, Bronce, Mate, Transp. decorado	608 €	658 €
	Affumicato decorado Bronce decorado Nuevos / Novos decorados *	680 €	736 €
ENTRADA MÍNIMA mm / ENTRADA MÍNIMO mm		598	698

Stock

Info

\* Para serigrafías digitales confirmar precio con ATC. / Para serigrafias digitais confirmar preço com ATC.

## VIDRIO Y DECORADO VIDRO E DECORADO

TRANSP.	AFFUMICATO	BRONCE	MATE
SIN DECORADO	SIN DECORADO	SIN DECORADO	SIN DECORADO
PICTOR	PICTOR	PICTOR	

## NUEVOS DECORADOS NOVOS DECORADOS

SERIGRAFIAS ESPECIALES		SERIGRAFIAS DIGITALES	
MIRAI	WETLANDS	BAMBOO	WAVE
GRID		FOG	

# technic

TS6 | MAMPARA DE DUCHA: 1 PUERTA BATIENTE MÁS LATERAL  
DIVISÓRIA DE DUCHE: 1 PORTA DE ABRIR MAIS LATERAL

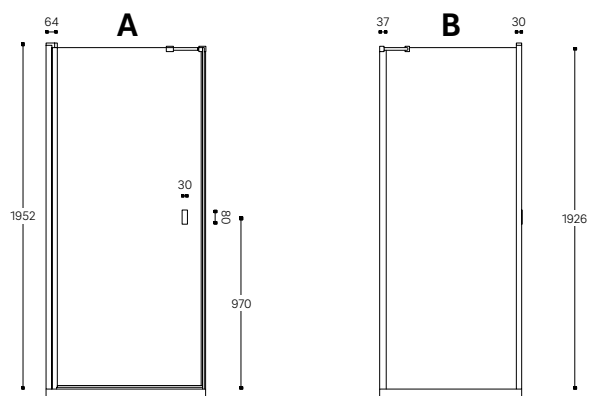

Dimensiones en mm.  
Dimensões em mm.



VIDRIO TEMPLADO  
VIDRO TEMPERADO  
6 MM



COMPENSACIÓN FRONTAL Y  
LATERAL  
COMPENSAÇÃO FRONTAL E  
LATERAL  
15 MM



ALTURA MODELO DUCHA  
ALTURA MODELO DUCHE  
1950 MM



REVERSIBLE  
REVERSÍVEL



APERTURA  
ABERTURA  
90°



MEDIDAS Y ALTURAS ESPECIALES  
MEDIDAS E ALTURAS ESPECIAIS  
(VER PÁG. / CONSULTA A PÁG. 372)



UP&DOWN  
UP&DOWN



TRATAMIENTO OPCIONAL (M)  
TRATAMENTO OPCIONAL (M)  
FRONTAL 55 € - LATERAL 35 €



Apto para adaptar a personas con movilidad reducida (bajo pedido)  
Adequado para acomodar as pessoas com mobilidade reduzida (a pedido)  
**+20% S/PVP**



MONTAJE  
MONTAJEM  
110 € \*

\* Precio recomendado  
Código montaje **CSM08**  
Para desplazamientos  
consultar pág. 373

\* Preço recomendado  
Código montagem **CSM08**  
Para deslocações  
consultar pág. 373

## ACABADOS METÁLICOS ACABAMENTOS METÁLICOS



BLANCO  
BRANCO



PLATA BRILLO  
PRATA BRILHO



PLATA MATE  
PRATA MATE

## TS6 | FRONTAL

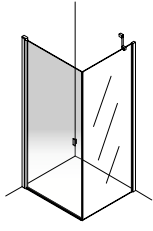

PERFIL BLANCO - PLATA BRILLO - PLATA MATE PERFIL BRANCO - PRATA BRILHO - PRATA MATE		A mm	
		600-800	801-1000
VIDRIO VIDRO	Transparente	486 €	526 €
	Affumicato, Bronce, Mate, Transp. decorado	608 €	658 €
	Affumicato decorado Bronce decorado Nuevos / Novos decorados *	680 €	736 €
ENTRADA MÍNIMA mm / ENTRADA MÍNIMO mm		518	718

## TLB | LATERAL

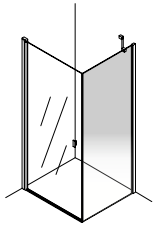

PERFIL BLANCO - PLATA BRILLO - PLATA MATE PERFIL BRANCO - PRATA BRILHO - PRATA MATE		B mm			
		200-400	401-600	601-800	801-1000
VIDRIO VIDRO	Transparente	237 €	260 €	290 €	318 €
	Affumicato, Bronce, Mate, Transp. decorado	296 €	325 €	363 €	398 €
	Affumicato decorado Bronce decorado Nuevos / Novos decorados *	332 €	364 €	406 €	445 €

\* Para serigrafías digitales confirmar precio con ATC. / Para serigrafias digitais confirmar preço com ATC.

### VIDRIO Y DECORADO VIDRO E DECORADO

TRANSP.



SIN DECORADO



PICTOR

AFFUMICATO



SIN DECORADO



PICTOR

BRONCE



SIN DECORADO



PICTOR

MATE



SIN DECORADO

### NUEVOS DECORADOS NOVOS DECORADOS

SERIGRAFÍAS ESPECIALES



MIRAI



WETLANDS



GRID

SERIGRAFÍAS DIGITALES



BAMBOO



WAVE



FOG

TSD | MAMPARA DE DUCHA: 2 PUERTAS BATIENTES ENTRE PAREDES  
 DIVISÓRIA DE DUCHE: 2 PORTAS DE ABRIR ENTRE PAREDE

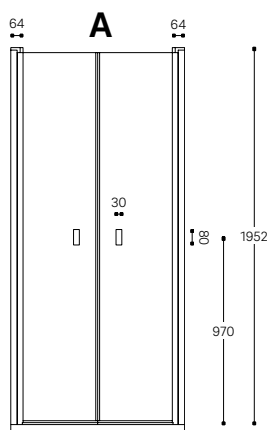

Dimensiones en mm.  
 Dimensões em mm.



VIDRIO TEMPLADO  
 VIDRO TEMPERADO  
**6 MM**



COMPENSACIÓN A CADA LADO  
 COMPENSAÇÃO A CADA LADO  
**15 MM**



ALTURA MODELO DUCHA  
 ALTURA MODELO DUCHE  
**1950 MM**



REVERSIBLE  
 REVERSÍVEL



APERTURA  
 ABERTURA  
**180°**



MEDIDAS Y ALTURAS ESPECIALES  
 MEDIDAS E ALTURAS ESPECIAIS  
 (VER PÁG. / CONSULTA A PÁG. **372**)



UP&DOWN  
 UP&DOWN



TRATAMIENTO OPCIONAL (M)  
 TRATAMENTO OPCIONAL (M)  
**65 €**



Apto para adaptar a personas con movilidad reducida (bajo pedido)  
 Adequado para acomodar as pessoas com mobilidade reduzida (a pedido)  
**+ 20% S/PVP**



MONTAJE  
 MONTAJEM  
**90 € \***

\* Precio recomendado  
 Código montaje **CSM04**  
 Para desplazamientos  
 consultar pág. **373**

\* Preço recomendado  
 Código montagem **CSM04**  
 Para deslocações  
 consultar pág. **373**

## ACABADOS METÁLICOS ACABAMENTOS METÁLICOS



BLANCO  
 BRANCO



PLATA BRILLO  
 PRATA BRILHO



PLATA MATE  
 PRATA MATE



# TSD | FRONTAL

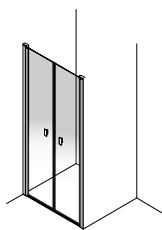

		<b>A mm</b>			
<b>PERFIL BLANCO - PLATA BRILLO - PLATA MATE</b> <b>PERFIL BRANCO - PRATA BRILHO - PRATA MATE</b>		<b>700-800</b>	<b>801-1000</b>	<b>1001-1200</b>	<b>1201-1400</b>
<b>VIDRIO</b> <b>VIDRO</b>	Transparente	647 €	688 €	729 €	768 €
	Affumicato, Bronce, Mate, Transp. decorado	809 €	860 €	911 €	960 €
	Affumicato decorado Bronce decorado Nuevos / Novos decorados *	906 €	963 €	1.021 €	1.075 €
ENTRADA MÍNIMA mm / ENTRADA MÍNIMO mm		558	659	859	1059

Stock

Info

\* Para serigrafías digitales confirmar precio con ATC. / Para serigrafias digitais confirmar preço com ATC.

## VIDRIO Y DECORADO VIDRO E DECORADO

<p><b>TRANSP.</b></p>  <p>SIN DECORADO</p>  <p>PICTOR</p>	<p><b>AFFUMICATO</b></p>  <p>SIN DECORADO</p>  <p>PICTOR</p>	<p><b>BRONCE</b></p>  <p>SIN DECORADO</p>  <p>PICTOR</p>	<p><b>MATE</b></p>  <p>SIN DECORADO</p>
---	--	--	--

## NUEVOS DECORADOS NOVOS DECORADOS

<p><b>SERIGRAFIAS ESPECIALES</b></p>  <p>MIRAI</p>  <p>WETLANDS</p>  <p>GRID</p>	<p><b>SERIGRAFIAS DIGITALES</b></p>  <p>BAMBOO</p>  <p>WAVE</p>  <p>FOG</p>
---	--

TSR | MAMPARA DE DUCHA: 1 PUERTA BATIENTE Y 1 FIJO ENTRE PAREDES  
 DIVISÓRIA DE DUCHE: 1 PORTA DE ABRIR E 1 FIXO ENTRE PAREDE

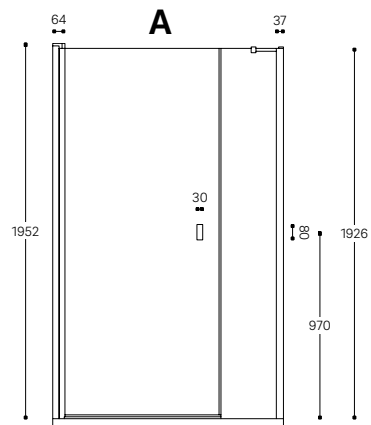

Dimensiones en mm.  
 Dimensões em mm.



VIDRIO TEMPLADO  
 VIDRO TEMPERADO  
**6 MM**



COMPENSACIÓN A CADA LADO  
 COMPENSAÇÃO A CADA LADO  
**15 MM**



ALTURA MODELO DUCHA  
 ALTURA MODELO DUCHE  
**1950 MM**



REVERSIBLE  
 REVERSÍVEL



APERTURA  
 ABERTURA  
**180°**



MEDIDAS Y ALTURAS ESPECIALES  
 MEDIDAS E ALTURAS ESPECIAIS  
 (VER PÁG. / CONSULTA A PÁG. **372**)



TRATAMIENTO OPCIONAL (M)  
 TRATAMENTO OPCIONAL (M)  
**65 €**



Apto para adaptar a personas con  
 movilidad reducida (bajo pedido)  
 Adequado para acomodar as  
 pessoas com mobilidade reduzida  
 (a pedido)  
**+ 20% S/PVP**



Para fijos mayores de 650 mm  
 el tirante va a pared contraria  
 Para fixos maiores de 650 mm  
 barra para parede oposta



UP&DOWN  
 UP&DOWN



MONTAJE  
 MONTAJEM  
**90 € \***

\* Precio recomendado  
 Código montaje **CSM04**  
 Para desplazamientos  
 consultar pág. **373**

\* Preço recomendado  
 Código montagem **CSM04**  
 Para deslocações  
 consultar pág. **373**

## ACABADOS METÁLICOS ACABAMENTOS METÁLICOS



BLANCO  
 BRANCO



PLATA BRILLO  
 PRATA BRILHO



PLATA MATE  
 PRATA MATE

# TSR | FRONTAL

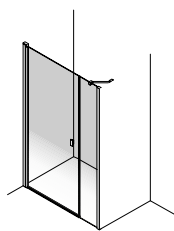

		<b>A mm</b>			
<b>PERFIL BLANCO - PLATA BRILLO - PLATA MATE</b> <b>PERFIL BRANCO - PRATA BRILHO - PRATA MATE</b>		<b>800-900</b>	<b>901-1300</b>	<b>1301-1600</b>	<b>1601-2000</b>
<b>VIDRIO</b> <b>VIDRO</b>	Transparente	630 €	670 €	717 €	763 €
	Affumicato, Bronce, Mate, Transp. decorado	788 €	838 €	896 €	954 €
	Affumicato decorado Bronce decorado Nuevos / Novos decorados *	882 €	938 €	1.004 €	1.068 €
ENTRADA MÍNIMA mm / ENTRADA MÍNIMO mm		500	600	700	800

\* Para serigrafías digitales confirmar precio con ATC. / Para serigrafias digitais confirmar preço com ATC.

## VIDRIO Y DECORADO VIDRO E DECORADO

TRANSP.



SIN DECORADO



PICTOR

AFFUMICATO



SIN DECORADO



PICTOR

BRONCE



SIN DECORADO



PICTOR

MATE



SIN DECORADO

## NUEVOS DECORADOS NOVOS DECORADOS

SERIGRAFÍAS ESPECIALES



MIRAI



WETLANDS



GRID

SERIGRAFÍAS DIGITALES



BAMBOO



WAVE



FOG

# technic

TST | MAMPARA DE DUCHA: 1 PUERTA BATIENTE Y 1 FIJO MÁS LATERAL  
 DIVISÓRIA DE DUCHE: 1 PORTA DE ABRIR E 1 FIXO MAIS LATERAL

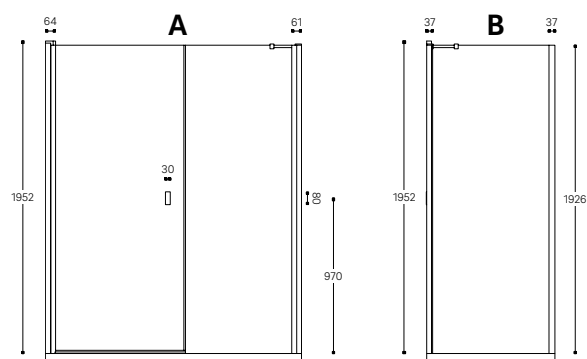

Dimensiones en mm.  
 Dimensões em mm.



VIDRIO TEMPLADO  
 VIDRO TEMPERADO  
**6 MM**



COMPENSACIÓN A CADA LADO  
 EN FRONTAL Y LATERAL **15 MM**  
 COMPENSAÇÃO A CADA LADO  
 EM FRONTAL E LATERAL **15 MM**



ALTURA MODELO DUCHA  
 ALTURA MODELO DUCHE  
**1950 MM**



REVERSIBLE  
 REVERSÍVEL



APERTURA  
 ABERTURA  
**180°**



MEDIDAS Y ALTURAS ESPECIALES  
 MEDIDAS E ALTURAS ESPECIAIS  
 (VER PÁG. / CONSULTA A PÁG. **372**)



TRATAMIENTO OPCIONAL (M)  
 TRATAMENTO OPCIONAL (M)  
 FRONTAL **65 €** - LATERAL **35 €**



Apto para adaptar a personas con  
 movilidad reducida (bajo pedido)  
 Adequado para acomodar as  
 pessoas com mobilidade reduzida  
 (a pedido)  
**+ 20% S/PVP**



Para fijos mayores de 650 mm  
 el tirante va a pared contraria  
 Para fixos maiores de 650 mm  
 barra para parede oposta



UP&DOWN  
 UP&DOWN



MONTAJE  
 MONTAJEM  
**115 € \***

\* Precio recomendado  
 Código montaje **CSM09**  
 Para desplazamientos  
 consultar pág. **373**

\* Preço recomendado  
 Código montagem **CSM09**  
 Para deslocações  
 consultar pág. **373**

## ACABADOS METÁLICOS ACABAMENTOS METÁLICOS



BLANCO  
 BRANCO



PLATA BRILLO  
 PRATA BRILHO



PLATA MATE  
 PRATA MATE

## TST | FRONTAL

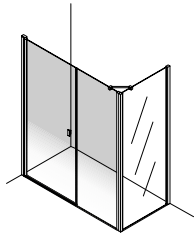

		A mm			
PERFIL BLANCO - PLATA BRILLO - PLATA MATE PERFIL BRANCO - PRATA BRILHO - PRATA MATE		800-900	901-1300	1301-1600	1601-2000
VIDRIO VIDRO	Transparente	630 €	670 €	717 €	763 €
	Affumicato, Bronce, Mate, Transp. decorado	788 €	838 €	896 €	954 €
	Affumicato decorado Bronce decorado Nuevos / Novos decorados *	882 €	938 €	1.004 €	1.068 €
ENTRADA MÍNIMA mm / ENTRADA MÍNIMO mm		500	600	700	800

## TLF | LATERAL

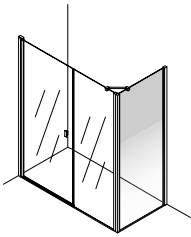

		B mm			
PERFIL BLANCO - PLATA BRILLO - PLATA MATE PERFIL BRANCO - PRATA BRILHO - PRATA MATE		200-400	401-600	601-800	801-1000
VIDRIO VIDRO	Transparente	260 €	283 €	313 €	341 €
	Affumicato, Bronce, Mate, Transp. decorado	325 €	354 €	391 €	426 €
	Affumicato decorado Bronce decorado Nuevos / Novos decorados *	364 €	396 €	438 €	477 €

\* Para serigrafías digitales confirmar precio con ATC. / Para serigrafias digitais confirmar preço com ATC.

### VIDRIO Y DECORADO VIDRO E DECORADO

TRANSP.



SIN DECORADO



PICTOR

AFFUMICATO



SIN DECORADO



PICTOR

BRONCE



SIN DECORADO



PICTOR

MATE



SIN DECORADO

### NUEVOS DECORADOS NOVOS DECORADOS

SERIGRAFÍAS ESPECIALES



MIRAI



WETLANDS



GRID

SERIGRAFÍAS DIGITALES



BAMBOO



WAVE



FOG

# technic

TS2 | MAMPARA DE DUCHA: 1 PUERTA BATIENTE Y 1 FIJO ENTRE PAREDES  
 DIVISÓRIA DE DUCHE: 1 PORTA DE ABRIR E 1 FIXO ENTRE PAREDE

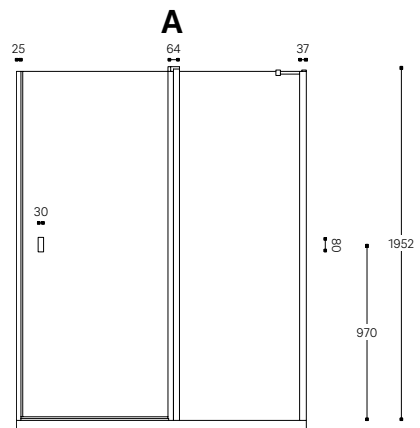

Dimensiones en mm.  
 Dimensões em mm.



VIDRIO TEMPLADO  
 VIDRO TEMPERADO  
**6 MM**



COMPENSACIÓN  
 COMPENSAÇÃO  
**25 MM**



ALTURA MODELO DUCHA  
 ALTURA MODELO DUCHE  
**1950 MM**



REVERSIBLE  
 REVERSÍVEL



APERTURA  
 ABERTURA  
**180°**



MEDIDAS Y ALTURAS ESPECIALES  
 MEDIDAS E ALTURAS ESPECIAIS  
 (VER PÁG. / CONSULTA A PÁG. **372**)



TRATAMIENTO OPCIONAL (M)  
 TRATAMENTO OPCIONAL (M)  
**65 €**



UP&DOWN  
 UP&DOWN



Apto para adaptar a personas con movilidad reducida (bajo pedido)  
 Adequado para acomodar as pessoas com mobilidade reduzida (a pedido)  
**+20% S/PVP**



MONTAJE  
 MONTAJEM  
**90 €\***

\* Precio recomendado  
 Código montaje **CSM04**  
 Para desplazamientos  
 consultar pág. **373**

\* Preço recomendado  
 Código montagem **CSM04**  
 Para deslocações  
 consultar pág. **373**

## ACABADOS METÁLICOS ACABAMENTOS METÁLICOS



BLANCO  
 BRANCO



PLATA BRILLO  
 PRATA BRILHO



PLATA MATE  
 PRATA MATE

## TS2 | FRONTAL

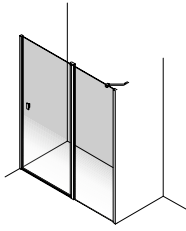

		<b>A mm</b>			
<b>PERFIL BLANCO - PLATA BRILLO - PLATA MATE</b> <b>PERFIL BRANCO - PRATA BRILHO - PRATA MATE</b>		<b>800-900</b>	<b>901-1300</b>	<b>1301-1600</b>	<b>1601-2000</b>
<b>VIDRIO</b> <b>VIDRO</b>	Transparente	630 €	670 €	717 €	763 €
	Affumicato, Bronce, Mate, Transp. decorado	788 €	838 €	896 €	954 €
	Affumicato decorado Bronce decorado Nuevos / Novos decorados *	882 €	938 €	1.004 €	1.068 €
ENTRADA MÍNIMA mm / ENTRADA MÍNIMO mm		500	600	700	800

\* Para serigrafías digitales confirmar precio con ATC. / Para serigrafias digitais confirmar preço com ATC.

### VIDRIO Y DECORADO VIDRO E DECORADO

TRANSP.



SIN DECORADO



PICTOR

AFFUMICATO



SIN DECORADO



PICTOR

BRONCE



SIN DECORADO



PICTOR

MATE



SIN DECORADO

### NUEVOS DECORADOS NOVOS DECORADOS

SERIGRAFÍAS ESPECIALES



MIRAI



WETLANDS



GRID

SERIGRAFÍAS DIGITALES



BAMBOO



WAVE



FOG

# technic

TS7 | MAMPARA DE DUCHA: 1 PUERTA BATIENTE Y 1 FIJO MÁS LATERAL  
 DIVISÓRIA DE DUCHE: 1 PORTA DE ABRIR E 1 FIXO MAIS LATERAL

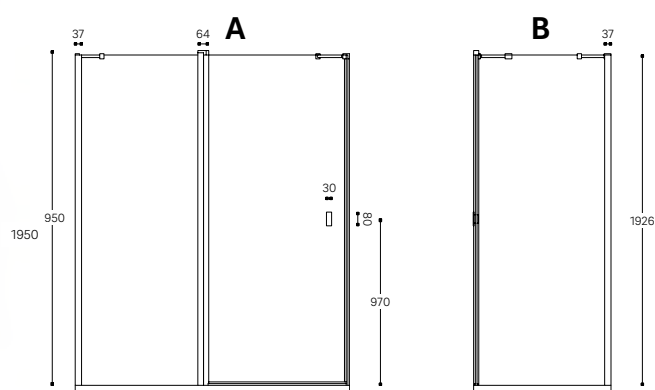

Dimensiones en mm.  
 Dimensões em mm.



VIDRIO TEMPLADO  
 VIDRO TEMPERADO  
**6 MM**



COMPENSACIÓN  
 COMPENSAÇÃO  
**15 MM**



ALTURA MODELO DUCHA  
 ALTURA MODELO DUCHE  
**1950 MM**



REVERSIBLE  
 REVERSÍVEL



APERTURA  
 ABERTURA  
**180°**



MEDIDAS Y ALTURAS ESPECIALES  
 MEDIDAS E ALTURAS ESPECIAIS  
 (VER PÁG. / CONSULTA A PÁG. **372**)



TRATAMIENTO OPCIONAL (M)  
 TRATAMENTO OPCIONAL (M)  
 FRONTAL **65 €** - LATERAL **35 €**



UP&DOWN  
 UP&DOWN



Apto para adaptar a personas con movilidad reducida (bajo pedido)  
 Adequado para acomodar as pessoas com mobilidade reduzida (a pedido)  
**+20% S/PVP**



MONTAJE  
 MONTAJEM  
**120 € \***

\* Precio recomendado  
 Código montaje **CSM10**  
 Para desplazamientos  
 consultar pág. **373**

\* Preço recomendado  
 Código montagem **CSM10**  
 Para deslocações  
 consultar pág. **373**

## ACABADOS METÁLICOS ACABAMENTOS METÁLICOS



BLANCO  
 BRANCO



PLATA BRILLO  
 PRATA BRILHO



PLATA MATE  
 PRATA MATE



## TS7 | FRONTAL

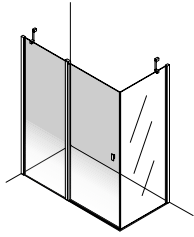

		A mm			
PERFIL BLANCO - PLATA BRILLO - PLATA MATE PERFIL BRANCO - PRATA BRILHO - PRATA MATE		800-900	901-1300	1301-1600	1601-2000
VIDRIO VIDRO	Transparente	630 €	670 €	717 €	763 €
	Affumicato, Bronce, Mate, Transp. decorado	788 €	838 €	896 €	954 €
	Affumicato decorado Bronce decorado Nuevos / Novos decorados *	882 €	938 €	1.004 €	1.068 €
ENTRADA MÍNIMA mm / ENTRADA MÍNIMO mm		500	600	700	800

## TLB | LATERAL

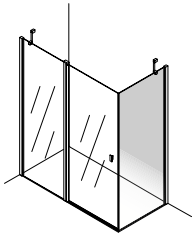

		B mm			
PERFIL BLANCO - PLATA BRILLO - PLATA MATE PERFIL BRANCO - PRATA BRILHO - PRATA MATE		200-400	401-600	601-800	801-1000
VIDRIO VIDRO	Transparente	237 €	260 €	290 €	318 €
	Affumicato, Bronce, Mate, Transp. decorado	296 €	325 €	363 €	398 €
	Affumicato decorado Bronce decorado Nuevos / Novos decorados *	332 €	364 €	406 €	445 €

\* Para serigrafías digitales confirmar precio con ATC. / Para serigrafias digitais confirmar preço com ATC.

### VIDRIO Y DECORADO VIDRO E DECORADO

TRANSP.



SIN DECORADO



PICTOR

AFFUMICATO



SIN DECORADO



PICTOR

BRONCE



SIN DECORADO



PICTOR

MATE



SIN DECORADO

### NUEVOS DECORADOS NOVOS DECORADOS

SERIGRAFÍAS ESPECIALES



MIRAI



WETLANDS



GRID

SERIGRAFÍAS DIGITALES



BAMBOO



WAVE



FOG

# technic

TSS | MAMPARA DE DUCHA: 1 PUERTA BATIENTE Y 1 FIJO MÁS LATERAL  
 DIVISÓRIA DE DUCHE: 1 PORTA DE ABRIR E 1 FIX MAIS LATERAL

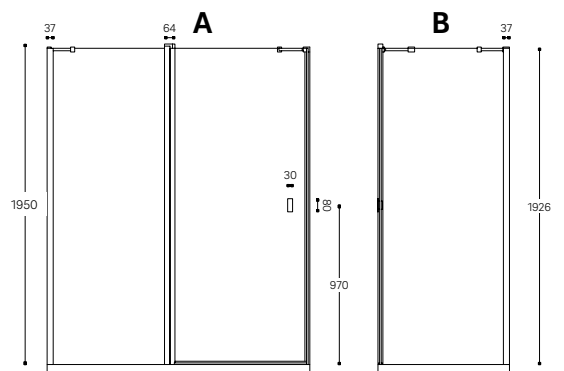

Dimensiones en mm.  
 Dimensões em mm.



VIDRIO TEMPLADO  
 VIDRO TEMPERADO  
**6 MM**



COMPENSACIÓN A CADA LADO  
 EN FRONTAL Y LATERAL **15 MM**  
 COMPENSAÇÃO A CADA LADO  
 EM FRONTAL E LATERAL **15 MM**



ALTURA MODELO DUCHA  
 ALTURA MODELO DUCHE  
**1950 MM**



REVERSIBLE  
 REVERSÍVEL



APERTURA  
 ABERTURA  
**180°**



MEDIDAS Y ALTURAS ESPECIALES  
 MEDIDAS E ALTURAS ESPECIAIS  
 (VER PÁG. / CONSULTA A PÁG. **372**)



TRATAMIENTO OPCIONAL (M)  
 TRATAMENTO OPCIONAL (M)  
 FRONTAL **65 €** - LATERAL **35 €**



UP&DOWN  
 UP&DOWN



Apto para adaptar a personas con movilidad reducida (bajo pedido)  
 Adequado para acomodar as pessoas com mobilidade reduzida (a pedido)  
**+20% S/PVP**



MONTAJE  
 MONTAJEM  
**120 € \***

\* Precio recomendado  
 Código montaje **CSM10**  
 Para desplazamientos  
 consultar pág. **373**

\* Preço recomendado  
 Código montagem **CSM10**  
 Para deslocações  
 consultar pág. **373**

## ACABADOS METÁLICOS ACABAMENTOS METÁLICOS



BLANCO  
 BRANCO



PLATA BRILLO  
 PRATA BRILHO



PLATA MATE  
 PRATA MATE

## TSS | FRONTAL

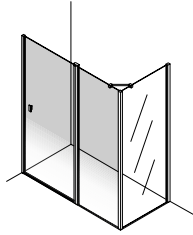

		A mm			
PERFIL BLANCO - PLATA BRILLO - PLATA MATE PERFIL BRANCO - PRATA BRILHO - PRATA MATE		800-900	901-1300	1301-1600	1601-2000
VIDRIO VIDRO	Transparente	630 €	670 €	717 €	763 €
	Affumicato, Bronce, Mate, Transp. decorado	788 €	838 €	896 €	954 €
	Affumicato decorado Bronce decorado Nuevos / Novos decorados *	882 €	938 €	1.004 €	1.068 €
ENTRADA MÍNIMA mm / ENTRADA MÍNIMO mm		500	600	700	800

## TLS | LATERAL

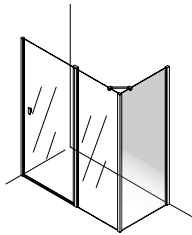

		B mm			
PERFIL BLANCO - PLATA BRILLO - PLATA MATE PERFIL BRANCO - PRATA BRILHO - PRATA MATE		200-400	401-600	601-800	801-1000
VIDRIO VIDRO	Transparente	260 €	283 €	313 €	341 €
	Affumicato, Bronce, Mate, Transp. decorado	325 €	354 €	391 €	426 €
	Affumicato decorado Bronce decorado Nuevos / Novos decorados *	364 €	396 €	438 €	477 €

\* Para serigrafías digitales confirmar precio con ATC. / Para serigrafias digitais confirmar preço com ATC.

### VIDRIO Y DECORADO VIDRO E DECORADO

TRANSP.



SIN DECORADO



PICTOR

AFFUMICATO



SIN DECORADO



PICTOR

BRONCE



SIN DECORADO



PICTOR

MATE



SIN DECORADO

### NUEVOS DECORADOS NOVOS DECORADOS

SERIGRAFÍAS ESPECIALES



MIRAI



WETLANDS



GRID

SERIGRAFÍAS DIGITALES



BAMBOO



WAVE



FOG

# technic

TP2 | MAMPARA DE DUCHA: 2 PUERTAS PLEGABLES ENTRE PAREDES  
DIVISÓRIA DE DUCHE: 2 PORTAS DOBRÁVEIS ENTRE PAREDE

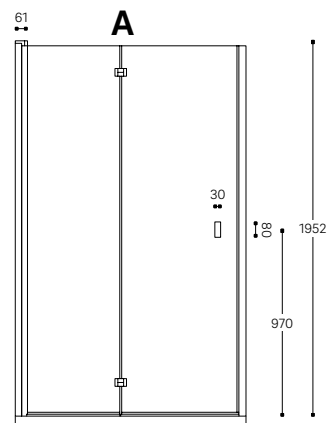

Dimensiones en mm.  
Dimensões em mm.



VIDRIO TEMPLADO  
VIDRO TEMPERADO  
6 MM



COMPENSACIÓN  
COMPENSAÇÃO  
25 MM



ALTURA MODELO DUCHA  
ALTURA MODELO DUCHE  
1950 MM



PLEGABLE  
FOLDABLE



APERTURA  
ABERTURA  
180°



MEDIDAS Y ALTURAS ESPECIALES  
MEDIDAS E ALTURAS ESPECIAIS  
(VER PÁG. / CONSULTA A PÁG. 372)



TRATAMIENTO OPCIONAL (M)  
TRATAMENTO OPCIONAL (M)  
65 €



UP&DOWN  
UP&DOWN



Disponible con doble tirador bajo pedido (sin aumento de precio)  
Disponível com tirador duplo a pedido (mesmo preço)



MONTAJE  
MONTAJEM  
90 € \*

\* Precio recomendado  
Código montaje **CSM04**  
Para desplazamientos  
consultar pág. 373

\* Preço recomendado  
Código montagem **CSM04**  
Para deslocações  
consultar pág. 373

## ACABADOS METÁLICOS ACABAMENTOS METÁLICOS



BLANCO  
BRANCO



PLATA BRILLO  
PRATA BRILHO



PLATA MATE  
PRATA MATE

## TP2 | FRONTAL

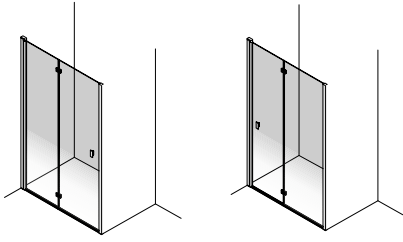

**L** IZQUIERDA  
ESQUERDA

**R** DERECHA  
DIREITA

FIJACIÓN / FIXAÇÃO

**PERFIL BLANCO - PLATA BRILLO - PLATA MATE**  
**PERFIL BRANCO - PRATA BRILHO - PRATA MATE**

**A mm**

	600-800	801-1000
VIDRIO VIDRO		
Transparente	647 €	688 €
Affumicato, Bronze, Mate, Transp. decorado	809 €	860 €
Affumicato decorado Bronce decorado Nuevos / Novos decorados *	906 €	963 €
ENTRADA MÍNIMA mm / ENTRADA MÍNIMO mm	492	692

\* Para serigrafías digitales confirmar precio con ATC. / Para serigrafias digitais confirmar preço com ATC.

### VIDRIO Y DECORADO VIDRO E DECORADO

TRANSP.



SIN DECORADO



PICTOR

AFFUMICATO



SIN DECORADO



PICTOR

BRONCE



SIN DECORADO



PICTOR

MATE



SIN DECORADO

### NUEVOS DECORADOS NOVOS DECORADOS

SERIGRAFIAS ESPECIALES



MIRAI



WETLANDS



GRID

SERIGRAFIAS DIGITALES



BAMBOO



WAVE



FOG

# technic

TP7 | MAMPARA DE DUCHA: 2 PUERTAS PLEGABLES MÁS LATERAL  
 DIVISÓRIA DE DUCHE: 2 PORTAS DOBRÁVEIS MAIS LATERAL

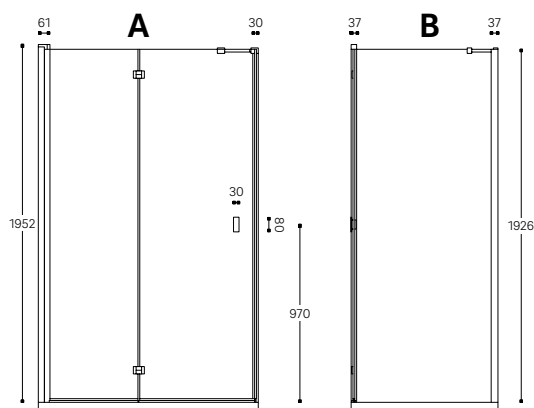

Dimensiones en mm.  
 Dimensões em mm.



VIDRIO TEMPLADO  
 VIDRO TEMPERADO  
**6 MM**



COMPENSACIÓN FRONTAL Y  
 LATERAL  
 COMPENSAÇÃO FRONTAL E  
 LATERAL  
**15 MM**



ALTURA MODELO DUCHA  
 ALTURA MODELO DUCHE  
**1950 MM**



PLEGABLE  
 FOLDABLE



APERTURA  
 ABERTURA  
**180°**



MEDIDAS Y ALTURAS ESPECIALES  
 MEDIDAS E ALTURAS ESPECIAIS  
 (VER PÁG. / CONSULTA A PÁG. **372**)



TRATAMIENTO OPCIONAL (M)  
 TRATAMENTO OPCIONAL (M)  
 FRONTAL **65 €** - LATERAL **35 €**



LATERAL REVERSIBLE  
 LATERAL REVERSÍVEL



Disponible con doble tirador bajo  
 pedido (sin aumento de precio)  
 Disponível com tirador duplo a pedido  
 (mesmo preço)



UP&DOWN  
 UP&DOWN



MONTAJE  
 MONTAJEM  
**115 € \***

\* Precio recomendado  
 Código montaje **CSM09**  
 Para desplazamientos  
 consultar pág. **373**

\* Preço recomendado  
 Código montagem **CSM09**  
 Para deslocações  
 consultar pág. **373**

## ACABADOS METÁLICOS ACABAMENTOS METÁLICOS



BLANCO  
 BRANCO



PLATA BRILLO  
 PRATA BRILHO



PLATA MATE  
 PRATA MATE

## TP7 | FRONTAL

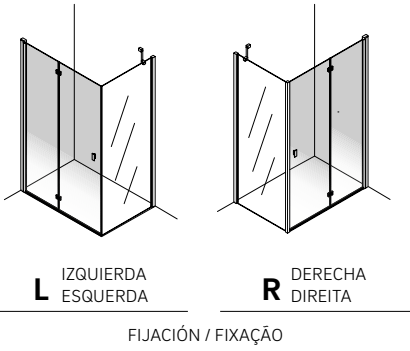

PERFIL BLANCO - PLATA BRILLO - PLATA MATE PERFIL BRANCO - PRATA BRILHO - PRATA MATE		A mm	
		600-800	801-1000
VIDRIO VIDRO	Transparente	647 €	688 €
	Affumicato, Bronce, Mate, Transp. decorado	809 €	860 €
	Affumicato decorado Bronce decorado Nuevos / Novos decorados *	906 €	963 €
ENTRADA MÍNIMA mm / ENTRADA MÍNIMO mm		514	714

## TLP | LATERAL

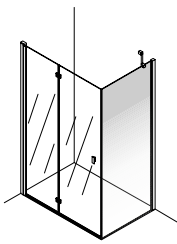

PERFIL BLANCO - PLATA BRILLO - PLATA MATE PERFIL BRANCO - PRATA BRILHO - PRATA MATE		B mm			
		200-400	401-600	601-800	801-1000
VIDRIO VIDRO	Transparente	260 €	283 €	313 €	341 €
	Affumicato, Bronce, Mate, Transp. decorado	325 €	354 €	391 €	426 €
	Affumicato decorado Bronce decorado Nuevos / Novos decorados *	364 €	396 €	438 €	477 €

\* Para serigrafías digitales confirmar precio con ATC. / Para serigrafias digitais confirmar preço com ATC.

### VIDRIO Y DECORADO VIDRO E DECORADO



### NUEVOS DECORADOS NOVOS DECORADOS



# technic

TPR

MAMPARA DE DUCHA: 2 PUERTAS PLEGABLES CONTRA UN FIJO ENTRE PAREDES  
 DIVISÓRIA DE DUCHE: 2 PORTAS DOBRÁVEIS CONTRA UN FISSO ENTRE PAREDE

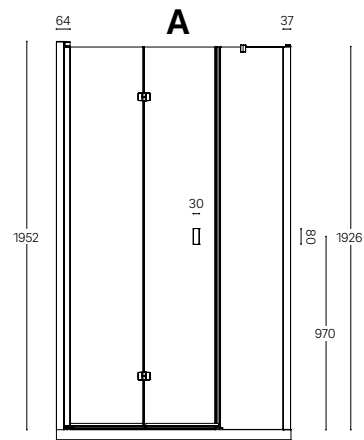

Dimensiones en mm.  
 Dimensões em mm.



VIDRIO TEMPLADO  
 VIDRO TEMPERADO  
**6 MM**



COMPENSACIÓN A CADA LADO  
 COMPENSAÇÃO EM CADA LADO  
**15 MM**



ALTURA ESTÁNDAR  
 ALTURA NORMA  
**1950 MM**



UP&DOWN  
 UP&DOWN



MEDIDAS Y ALTURAS ESPECIALES  
 MEDIDAS E ALTURAS ESPECIAIS  
 (VER PÁG. / CONSULTA A PÁG. **372**)



PLEGABLE  
 FOLDABLE



TRATAMIENTO OPCIONAL (M)  
 TRATAMENTO OPCIONAL (M)  
 FRONTAL **85 €**



MONTAJE  
 MONTAJEM  
**95 € \***

\* Precio recomendado  
 Código montaje **CSM05**  
 Para desplazamientos  
 consultar pág. **373**

\* Preço recomendado  
 Código montagem **CSM05**  
 Para deslocações  
 consultar pág. **373**

## ACABADOS METÁLICOS ACABAMENTOS METÁLICOS



BLANCO  
 BRANCO



PLATA BRILLO  
 PRATA BRILHO



PLATA MATE  
 PRATA MATE



TPR | **FRONTAL**

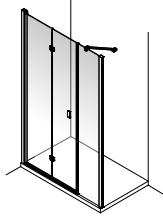

PERFIL BLANCO - PLATA BRILLO - PLATA MATE PERFIL BRANCO - PRATA BRILHO - PRATA MATE		A mm			
		850-1200	1201-1400	1401-1600	1601-1800
VIDRIO VIDRO	Transparente	693 €	732 €	770 €	809 €
	Affumicato, Bronce, Mate, Transp. decorado	866 €	915 €	963 €	1.011 €
	Affumicato decorado Bronce decorado Nuevos / Novos decorados *	970 €	1.025 €	1.078 €	1.133 €
MEDIDA DEL FIJO / MEDIDA DO FIXO mm			250-800		
MEDIDA PARTE PLEGABLE / MEDIDA PEÇA DOBRÁVEL mm			600-1000		



Stock

Info

\* Para serigrafías digitales confirmar precio con ATC. / Para serigrafias digitais confirmar preço com ATC.

**VIDRIO Y DECORADO  
VIDRO E DECORADO**

TRANSP.	AFFUMICATO	BRONCE	MATE
SIN DECORADO	SIN DECORADO	SIN DECORADO	SIN DECORADO
PICTOR	PICTOR	PICTOR	

**NUEVOS DECORADOS  
NOVOS DECORADOS**

SERIGRAFÍAS ESPECIALES		SERIGRAFÍAS DIGITALES	
MIRAI	WETLANDS	BAMBOO	WAVE
GRID		FOG	

# technic

TP3 | MAMPARA DE DUCHA: 2 PUERTAS PLEGABLES Y UN SEGMENTO ENTRE PAREDES  
 DIVISÓRIA DE DUCHE: 2 PORTAS DOBRÁVEIS E SEGMENTO ENTRE PAREDE

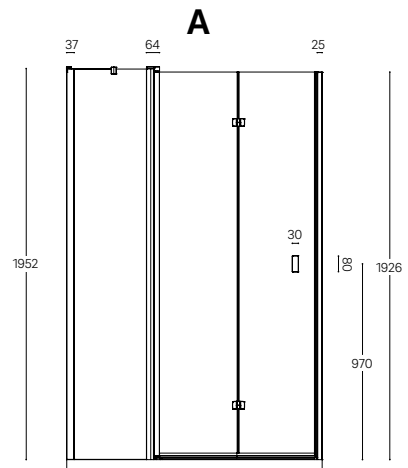

Dimensiones en mm.  
 Dimensões em mm.



VIDRIO TEMPLADO  
 VIDRO TEMPERADO  
**6 MM**



COMPENSACIÓN A CADA LADO  
 COMPENSAÇÃO EM CADA LADO  
**15 MM**



ALTURA ESTÁNDAR  
 ALTURA NORMA  
**1950 MM**



UP&DOWN  
 UP&DOWN



MEDIDAS Y ALTURAS ESPECIALES  
 MEDIDAS E ALTURAS ESPECIAIS  
 (VER PÁG. / CONSULTA A PÁG. **372**)



PLEGABLE  
 FOLDABLE



TRATAMIENTO OPCIONAL (M)  
 TRATAMENTO OPCIONAL (M)  
 FRONTAL **85 €**



MONTAJE  
 MONTAJEM  
**95 € \***

\* Precio recomendado  
 Código montaje **CSM05**  
 Para desplazamientos  
 consultar pág. **373**

\* Preço recomendado  
 Código montagem **CSM05**  
 Para deslocações  
 consultar pág. **373**

## ACABADOS METÁLICOS ACABAMENTOS METÁLICOS



BLANCO  
 BRANCO



PLATA BRILLO  
 PRATA BRILHO



PLATA MATE  
 PRATA MATE

# TP3 | FRONTAL

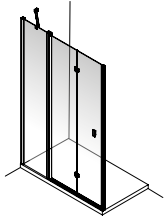

PERFIL BLANCO - PLATA BRILLO - PLATA MATE PERFIL BRANCO - PRATA BRILHO - PRATA MATE		A mm			
		850-1200	1201-1400	1401-1600	1601-1800
VIDRIO VIDRO	Transparente	693 €	732 €	770 €	809 €
	Affumicato, Bronce, Mate, Transp. decorado	866 €	915 €	963 €	1.011 €
	Affumicato decorado Bronce decorado Nuevos / Novos decorados *	970 €	1.025 €	1.078 €	1.133 €
MEDIDA DEL FIJO / MEDIDA DO FIXO mm			250-800		
MEDIDA PARTE PLEGABLE / MEDIDA PEÇA DOBRÁVEL mm			600-1000		

\* Para serigrafías digitales confirmar precio con ATC. / Para serigrafias digitais confirmar preço com ATC.

## VIDRIO Y DECORADO VIDRO E DECORADO

TRANSP.	AFFUMICATO	BRONCE	MATE
SIN DECORADO	SIN DECORADO	SIN DECORADO	SIN DECORADO
PICTOR	PICTOR	PICTOR	

## NUEVOS DECORADOS NOVOS DECORADOS

SERIGRAFÍAS ESPECIALES		SERIGRAFÍAS DIGITALES	
MIRAI	WETLANDS	BAMBOO	WAVE
GRID		FOG	

# technic

TS3 | MAMPARA DE DUCHA: 1 PUERTA BATIENTE Y 2 FIJOS ENTRE PAREDES  
 DIVISÓRIA DE DUCHE: 1 PORTA DE ABRIR E 2 FIXOS ENTRE PAREDE

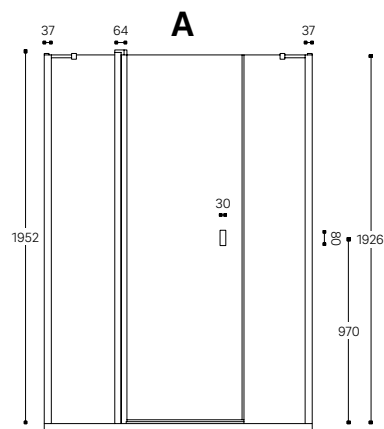

Dimensiones en mm.  
 Dimensões em mm.



VIDRIO TEMPLADO  
 VIDRO TEMPERADO  
**6** MM



COMPENSACIÓN A CADA LADO  
 COMPENSAÇÃO A CADA LADO  
**15** MM



ALTURA MODELO DUCHA  
 ALTURA MODELO DUCHE  
**1950** MM



REVERSIBLE  
 REVERSÍVEL



APERTURA  
 ABERTURA  
**180°**



MEDIDAS Y ALTURAS ESPECIALES  
 MEDIDAS E ALTURAS ESPECIAIS  
 (VER PÁG. / CONSULTA A PÁG. **372**)



TRATAMIENTO OPCIONAL (M)  
 TRATAMENTO OPCIONAL (M)  
**85** €



Apto para adaptar a personas  
 con movilidad reducida (bajo  
 pedido)  
 Adequado para acomodar  
 as pessoas com mobilidade  
 reduzida (a pedido)  
**+20% S/PVP**



Para medida superior a 1400mm  
 el tirante va a pared contraria.  
 Para medidas maiores a 1400mm  
 la barra para parede oposta.



UP&DOWN  
 UP&DOWN



MONTAJE  
 MONTAJEM  
**95** € \*

\* Precio recomendado  
 Código montaje **CSM05**  
 Para desplazamientos  
 consultar pág. **373**

\* Preço recomendado  
 Código montagem **CSM05**  
 Para deslocações  
 consultar pág. **373**

## ACABADOS METÁLICOS ACABAMENTOS METÁLICOS



BLANCO  
 BRANCO



PLATA BRILLO  
 PRATA BRILHO



PLATA MATE  
 PRATA MATE

# TS3 | FRONTAL

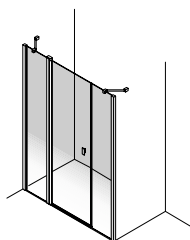

PERFIL BLANCO - PLATA BRILLO - PLATA MATE PERFIL BRANCO - PRATA BRILHO - PRATA MATE		A mm			
		1000-1200	1201-1500	1501-1800	1801-2200
VIDRIO VIDRO	Transparente	861 €	901 €	942 €	983 €
	Affumicato, Bronce, Mate, Transp. decorado	1.076 €	1.126 €	1.178 €	1.229 €
	Affumicato decorado Bronce decorado Nuevos / Novos decorados *	1.205 €	1.261 €	1.319 €	1.376 €
ENTRADA MÍNIMA mm / ENTRADA MÍNIMO mm		500	600	700	800

\* Para serigrafías digitales confirmar precio con ATC. / Para serigrafias digitais confirmar preço com ATC.

## VIDRIO Y DECORADO VIDRO E DECORADO

TRANSP.



SIN DECORADO



PICTOR

AFFUMICATO



SIN DECORADO



PICTOR

BRONCE



SIN DECORADO



PICTOR

MATE



SIN DECORADO

## NUEVOS DECORADOS NOVOS DECORADOS

SERIGRAFIAS ESPECIALES



MIRAI



WETLANDS



GRID

SERIGRAFIAS DIGITALES



BAMBOO



WAVE



FOG

# technic

TS8 | MAMPARA DE DUCHA: 1 PUERTA BATIENTE Y 2 FIJOS MÁS LATERAL  
 DIVISÓRIA DE DUCHE: 1 PORTA DE ABRIR E 2 FIXOS MAIS LATERAL

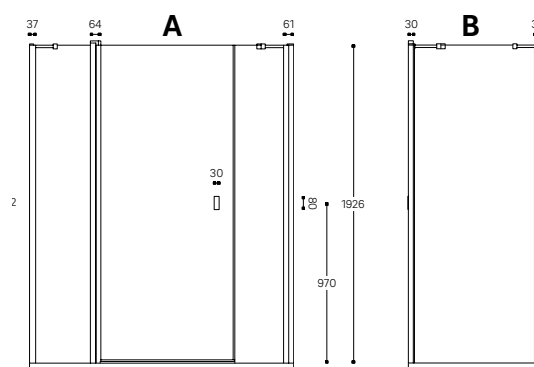

Dimensiones en mm.  
 Dimensões em mm.



VIDRIO TEMPLADO  
 VIDRO TEMPERADO  
**6 MM**



COMPENSACIÓN A CADA LADO  
 EN FRONTAL Y LATERAL **15 MM**  
 COMPENSAÇÃO A CADA LADO  
 EM FRONTAL E LATERAL **15 MM**



ALTURA MODELO DUCHA  
 ALTURA MODELO DUCHE  
**1950 MM**



UP&DOWN  
 UP&DOWN



APERTURA  
 ABERTURA  
**180°**



MEDIDAS Y ALTURAS ESPECIALES  
 MEDIDAS E ALTURAS ESPECIAIS  
 (VER PÁG. / CONSULTA A PÁG. **372**)



TRATAMIENTO OPCIONAL (M)  
 TRATAMENTO OPCIONAL (M)  
 FRONTAL **85 €** - LATERAL **35 €**



REVERSIBLE  
 REVERSÍVEL



Apto para adaptar a personas  
 con movilidad reducida (bajo  
 pedido)  
 Adequado para acomodar  
 as pessoas com mobilidade  
 reduzida (a pedido)  
**+20% S/PVP**



MONTAJE  
 MONTAJEM  
**120 € \***

\* Precio recomendado  
 Código montaje **CSM10**  
 Para desplazamientos  
 consultar pág. **373**

\* Preço recomendado  
 Código montagem **CSM10**  
 Para deslocações  
 consultar pág. **373**

## ACABADOS METÁLICOS ACABAMENTOS METÁLICOS



BLANCO  
 BRANCO



PLATA BRILLO  
 PRATA BRILHO



PLATA MATE  
 PRATA MATE

## TS8 | FRONTAL

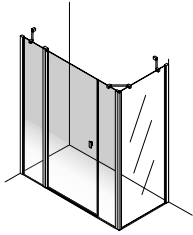

		A mm			
PERFIL BLANCO - PLATA BRILLO - PLATA MATE PERFIL BRANCO - PRATA BRILHO - PRATA MATE		1000-1200	1201-1500	1501-1800	1801-2200
VIDRIO VIDRO	Transparente	861 €	901 €	942 €	983 €
	Affumicato, Bronce, Mate, Transp. decorado	1.076 €	1.126 €	1.178 €	1.229 €
	Affumicato decorado Bronce decorado Nuevos / Novos decorados *	1.205 €	1.261 €	1.319 €	1.376 €
ENTRADA MÍNIMA mm / ENTRADA MÍNIMO mm		500	600	700	800

## TLF | LATERAL B1

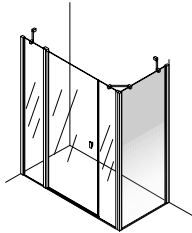

		B mm			
PERFIL BLANCO - PLATA BRILLO - PLATA MATE PERFIL BRANCO - PRATA BRILHO - PRATA MATE		200-400	401-600	601-800	801-1000
VIDRIO VIDRO	Transparente	260 €	283 €	313 €	341 €
	Affumicato, Bronce, Mate, Transp. decorado	325 €	354 €	391 €	426 €
	Affumicato decorado Bronce decorado Nuevos / Novos decorados *	364 €	396 €	438 €	477 €

## TLS | LATERAL B2

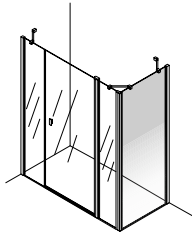

		B mm			
PERFIL BLANCO - PLATA BRILLO - PLATA MATE PERFIL BRANCO - PRATA BRILHO - PRATA MATE		200-400	401-600	601-800	801-1000
VIDRIO VIDRO	Transparente	260 €	283 €	313 €	341 €
	Affumicato, Bronce, Mate, Transp. decorado	325 €	354 €	391 €	426 €
	Affumicato decorado Bronce decorado Nuevos / Novos decorados *	364 €	396 €	438 €	477 €

\* Para serigrafías digitales confirmar precio con ATC. / Para serigrafías digitais confirmar preço com ATC.

### VIDRIO Y DECORADO VIDRO E DECORADO

TRANSP.	AFFUMICATO	BRONCE	MATE
SIN DECORADO	SIN DECORADO	SIN DECORADO	SIN DECORADO
PICTOR	PICTOR	PICTOR	

### NUEVOS DECORADOS NOVOS DECORADOS

SERIGRAFÍAS ESPECIALES		SERIGRAFÍAS DIGITALES	
MIRAI	WETLANDS	BAMBOO	WAVE
GRID		FOG	

# technic

TS4 | FRONTAL DE DUCHA: 2 PUERTAS BATIENTES Y 2 FIJOS ENTRE PAREDES  
 DIVISÓRIA DE DUCHE: 2 PORTAS DE ABRIR E 2 FIXOS ENTRE PAREDE

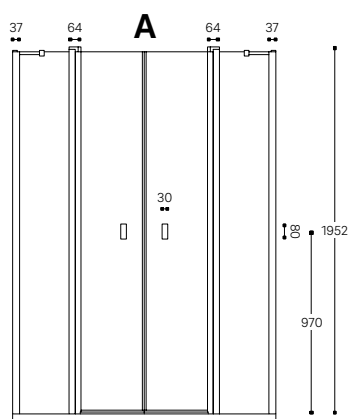

Dimensiones en mm.  
 Dimensões em mm.



VIDRIO TEMPLADO  
 VIDRO TEMPERADO  
**6** MM



COMPENSACIÓN A CADA LADO  
 COMPENSAÇÃO A CADA LADO  
**15** MM



ALTURA MODELO DUCHA  
 ALTURA MODELO DUCHE  
**1950** MM



UP&DOWN  
 UP&DOWN



APERTURA  
 ABERTURA  
**180°**



MEDIDAS Y ALTURAS ESPECIALES  
 MEDIDAS E ALTURAS ESPECIAIS  
 (VER PÁG. / CONSULTA A PÁG. **372**)



TRATAMIENTO OPCIONAL (M)  
 TRATAMENTO OPCIONAL (M)  
**95** €



REVERSIBLE  
 REVERSÍVEL



Apto para adaptar a personas con movilidad reducida (bajo pedido)  
 Adequado para acomodar as pessoas com mobilidade reduzida (a pedido)  
**+ 20%** S/PVP



MONTAJE  
 MONTAJEM  
**100** € \*

\* Precio recomendado  
 Código montaje **CSM06**  
 Para desplazamientos  
 consultar pág. **373**

\* Preço recomendado  
 Código montagem **CSM06**  
 Para deslocações  
 consultar pág. **373**

## ACABADOS METÁLICOS ACABAMENTOS METÁLICOS



BLANCO  
 BRANCO



PLATA BRILLO  
 PRATA BRILHO



PLATA MATE  
 PRATA MATE



# TS4 | FRONTAL

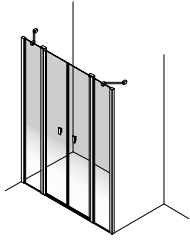

PERFIL BLANCO - PLATA BRILLO - PLATA MATE PERFIL BRANCO - PRATA BRILHO - PRATA MATE		A mm			
		1100-1300	1301-1500	1501-1800	1801-2200
VIDRIO VIDRO	Transparente	965 €	1.006 €	1.052 €	1.098 €
	Affumicato, Bronce, Mate, Transp. decorado	1.206 €	1.258 €	1.315 €	1.373 €
	Affumicato decorado Bronce decorado Nuevos / Novos decorados *	1.351 €	1.408 €	1.473 €	1.537 €
ENTRADA MÍNIMA mm / ENTRADA MÍNIMO mm		600	800	1000	1200

\* Para serigrafías digitales confirmar precio con ATC. / Para serigrafias digitais confirmar preço com ATC.

## VIDRIO Y DECORADO VIDRO E DECORADO

TRANSP.



SIN DECORADO



PICTOR

AFFUMICATO



SIN DECORADO



PICTOR

BRONCE



SIN DECORADO



PICTOR

MATE



SIN DECORADO

## NUEVOS DECORADOS NOVOS DECORADOS

SERIGRAFÍAS ESPECIALES



MIRAI



WETLANDS



GRID

SERIGRAFÍAS DIGITALES



BAMBOO



WAVE



FOG

# technic

TS9 | FRONTAL DE DUCHA: 2 PUERTAS BATIENTES Y 2 FIJOS MÁS LATERAL  
 DIVISÓRIA DE DUCHE: 2 PORTAS DE ABRIR E 2 FIXOS MAIS LATERAL

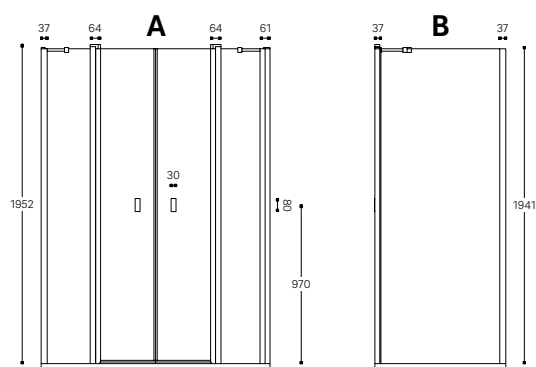

Dimensiones en mm.  
 Dimensões em mm.



VIDRIO TEMPLADO  
 VIDRO TEMPERADO  
**6 MM**



COMPENSACIÓN A CADA LADO  
 EN FRONTAL Y LATERAL **15 MM**  
 COMPENSAÇÃO A CADA LADO  
 EM FRONTAL E LATERAL **15 MM**



ALTURA MODELO DUCHA  
 ALTURA MODELO DUCHE  
**1950 MM**



UP&DOWN  
 UP&DOWN



APERTURA  
 ABERTURA  
**180°**



MEDIDAS Y ALTURAS ESPECIALES  
 MEDIDAS E ALTURAS ESPECIAIS  
 (VER PÁG. / CONSULTA A PÁG. **372**)



TRATAMIENTO OPCIONAL (M)  
 TRATAMENTO OPCIONAL (M)  
 FRONTAL **95 €** - LATERAL **35 €**



REVERSIBLE  
 REVERSÍVEL



Apto para adaptar a personas con movilidad reducida (bajo pedido)  
 Adequado para acomodar as pessoas com mobilidade reduzida (a pedido)  
**+20% S/PVP**



MONTAJE  
 MONTAJEM  
**125 € \***

\* Precio recomendado  
 Código montaje **CSM11**  
 Para desplazamientos  
 consultar pág. **373**

\* Preço recomendado  
 Código montagem **CSM11**  
 Para deslocações  
 consultar pág. **373**

## ACABADOS METÁLICOS ACABAMENTOS METÁLICOS



BLANCO  
 BRANCO



PLATA BRILLO  
 PRATA BRILHO



PLATA MATE  
 PRATA MATE

## TS9 | FRONTAL

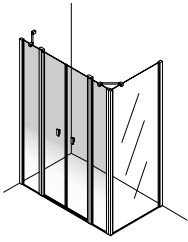

PERFIL BLANCO - PLATA BRILLO - PLATA MATE PERFIL BRANCO - PRATA BRILHO - PRATA MATE		A mm			
		1100-1300	1301-1500	1501-1800	1801-2200
VIDRIO VIDRO	Transparente	965 €	1.006 €	1.052 €	1.098 €
	Affumicato, Bronce, Mate, Transp. decorado	1.206 €	1.258 €	1.315 €	1.373 €
	Affumicato decorado Bronce decorado Nuevos / Novos decorados *	1.351 €	1.408 €	1.473 €	1.537 €
ENTRADA MÍNIMA mm / ENTRADA MÍNIMO mm		600	800	1000	1200

## TLS | LATERAL

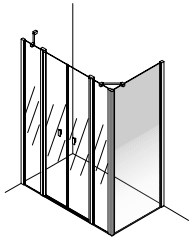

PERFIL BLANCO - PLATA BRILLO - PLATA MATE PERFIL BRANCO - PRATA BRILHO - PRATA MATE		B mm			
		200-400	401-600	601-800	801-1000
VIDRIO VIDRO	Transparente	260 €	283 €	313 €	341 €
	Affumicato, Bronce, Mate, Transp. decorado	325 €	354 €	391 €	426 €
	Affumicato decorado Bronce decorado Nuevos / Novos decorados *	364 €	396 €	438 €	477 €

\* Para serigrafías digitales confirmar precio con ATC. / Para serigrafias digitais confirmar preço com ATC.

### VIDRIO Y DECORADO VIDRO E DECORADO

TRANSP.



SIN DECORADO



PICTOR

AFFUMICATO



SIN DECORADO



PICTOR

BRONCE



SIN DECORADO



PICTOR

MATE



SIN DECORADO

### NUEVOS DECORADOS NOVOS DECORADOS

SERIGRAFÍAS ESPECIALES



MIRAI



WETLANDS



GRID

SERIGRAFÍAS DIGITALES



BAMBOO



WAVE



FOG

TSB | MAMPARA ANGULAR: 2 PUERTAS BATIENTES  
DIVISÓRIA ANGULAR: 2 PORTAS DE ABRIR

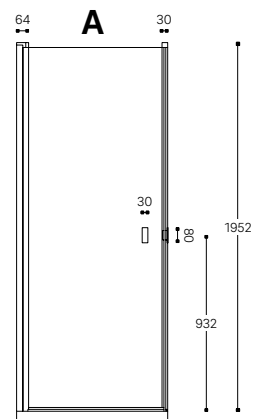

Dimensiones en mm.  
Dimensões em mm.



VIDRIO TEMPLADO  
VIDRO TEMPERADO  
6 MM



COMPENSACIÓN A CADA LADO  
COMPENSAÇÃO A CADA LADO  
15 MM



ALTURA MODELO DUCHA  
ALTURA MODELO DUCHE  
1950 MM



UP&DOWN  
UP&DOWN



APERTURA  
ABERTURA  
180°



MEDIDAS Y ALTURAS ESPECIALES  
MEDIDAS E ALTURAS ESPECIAIS  
(VER PÁG. / CONSULTA A PÁG. 372)



TRATAMIENTO OPCIONAL (M)  
TRATAMENTO OPCIONAL (M)  
37,50 €



REVERSIBLE  
REVERSÍVEL



Apto para adaptar a personas con movilidad reducida (bajo pedido)

Adequado para acomodar as pessoas com mobilidade reduzida (a pedido)

+20% S/PVP



MONTAJE  
MONTAJEM  
115 € \*

\* Precio recomendado  
Código montaje **CSM09**  
Para desplazamientos y alturas especiales  
consultar pág. 373

\* Preço recomendado  
Código montagem **CSM09**  
Para deslocações e alturas especiais  
consultar pág. 373

## ACABADOS METÁLICOS ACABAMENTOS METÁLICOS



BLANCO  
BRANCO



PLATA BRILLO  
PRATA BRILHO



PLATA MATE  
PRATA MATE

# TSB | ANGULAR

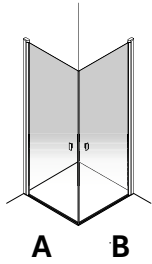

		<b>A mm</b>	
		550-800	801-1000
<b>PERFIL BLANCO - PLATA BRILLO - PLATA MATE</b> <b>PERFIL BRANCO - PRATA BRILHO - PRATA MATE</b>			
	Transparente	388 €	422 €
VIDRIO VIDRO	Affumicato, Bronce, Mate, Transp. decorado	485 €	528 €
	Affumicato decorado Bronce decorado Nuevos / Novos decorados *	543 €	591 €

		<b>B mm</b>	
		550-800	801-1000
<b>PERFIL BLANCO - PLATA BRILLO - PLATA MATE</b> <b>PERFIL BRANCO - PRATA BRILHO - PRATA MATE</b>			
	Transparente	388 €	422 €
VIDRIO VIDRO	Affumicato, Bronce, Mate, Transp. decorado	485 €	528 €
	Affumicato decorado Bronce decorado Nuevos / Novos decorados *	543 €	591 €

Para precio total, sumar ambos lados A y B.  
Para o preço total, some os dois lados A e B.

\* Para serigrafías digitales confirmar precio con ATC. / Para serigrafias digitais confirmar preço com ATC.

## VIDRIO Y DECORADO VIDRO E DECORADO



## NUEVOS DECORADOS NOVOS DECORADOS



# technic

TS5 | MAMPARA ANGULAR: 2 PUERTAS BATIENTES Y 2 FIJOS  
DIVISÓRIA ANGULAR: 2 PORTAS DE ABRIR E 2 FIXOS

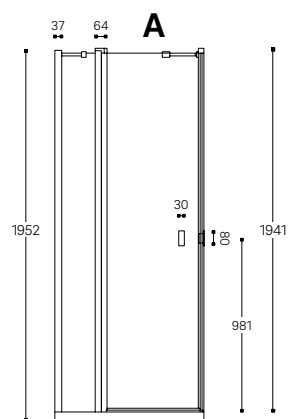

Dimensiones en mm.  
Dimensões em mm.



VIDRIO TEMPLADO  
VIDRO TEMPERADO  
6 MM



COMPENSACIÓN FRONTAL Y LATERAL  
COMPENSAÇÃO FRONTAL E LATERAL  
15 MM \*



ALTURA MODELO DUCHA  
ALTURA MODELO DUCHE  
1950 MM



ABERTURA  
ABERTURA  
180°



MEDIDAS Y ALTURAS ESPECIALES  
MEDIDAS E ALTURAS ESPECIAIS  
(VER PÁG. / CONSULTA A PÁG. 372)



TRATAMIENTO OPCIONAL (M)  
TRATAMENTO OPCIONAL (M)  
47,50 €



REVERSIBLE  
REVERSÍVEL



Apto para adaptar a personas con  
movilidad reducida (bajo pedido)  
Adequado para acomodar as pessoas  
com mobilidade reduzida (a pedido)  
**+ 20% S/PVP**



MONTAJE  
MONTAJEM  
125 € \*

\* Precio recomendado  
Código montaje **CSM11**  
Para desplazamientos  
consultar pág. 373

\* Preço recomendado  
Código montagem **CSM11**  
Para deslocações  
consultar pág. 373

## ACABADOS METÁLICOS ACABAMENTOS METÁLICOS



BLANCO  
BRANCO



PLATA BRILLO  
PRATA BRILHO



PLATA MATE  
PRATA MATE

# TS5 | ANGULAR

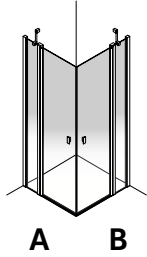

## PERFIL BLANCO - PLATA BRILLO - PLATA MATE PERFIL BRANCO - PRATA BRILHO - PRATA MATE

		A mm		
		800-900	901-1300	1301-1400
VIDRIO VIDRO	Transparente	503 €	538 €	572 €
	Affumicato, Bronce, Mate, Transp. decorado	629 €	673 €	715 €
	Affumicato decorado Bronce decorado Nuevos / Novos decorados *	704 €	753 €	801 €
MEDIDA PUERTA IZQUIERDA / PORTA ESQUERDA mm		500	500	500
MEDIDA PUERTA DEREITA 7 PORTA DIREITA mm		500	600	700

		B mm		
		800-900	901-1300	1301-1400
VIDRIO VIDRO	Transparente	503 €	538 €	572 €
	Affumicato, Bronce, Mate, Transp. decorado	629 €	673 €	715 €
	Affumicato decorado Bronce decorado Nuevos / Novos decorados *	704 €	753 €	801 €
MEDIDA PUERTA IZQUIERDA / PORTA ESQUERDA mm		500	500	500
MEDIDA PUERTA DEREITA 7 PORTA DIREITA mm		500	600	700

Para precio total, sumar ambos lados A y B.  
Para o preço total, some os dois lados A e B.

\* Para serigrafías digitales confirmar precio con ATC. / Para serigrafias digitais confirmar preço com ATC.

### VIDRIO Y DECORADO VIDRO E DECORADO



### NUEVOS DECORADOS NOVOS DECORADOS



Stock

Info

# technic

TP5 | MAMPARA ANGULAR DE PUERTAS PLEGABLES  
DIVISÓRIA ANGULAR DE PORTAS DOBRÁVEIS

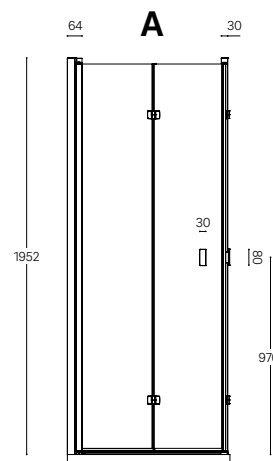

Dimensiones en mm.  
Dimensões em mm.



VIDRIO TEMPLADO  
VIDRO TEMPERADO  
6 MM



COMPENSACIÓN A CADA LADO  
COMPENSAÇÃO A CADA LADO  
15 MM



ALTURA ESTÁNDAR  
ALTURA NORMA  
1950 MM



REVERSIBLE  
REVERSÍVEL



MEDIDAS Y ALTURAS ESPECIALES  
MEDIDAS E ALTURAS ESPECIAIS  
(VER PÁG. / CONSULTA A PÁG. 372)



PLEGABLE  
FOLDABLE



TRATAMIENTO OPCIONAL (M)  
TRATAMENTO OPCIONAL (M)  
FRONTAL 47,50 €



MONTAJE  
MONTAJEM  
125 € \*

\* Precio recomendado  
Código montaje **CSM11**  
Para desplazamientos  
consultar pág. 373

\* Preço recomendado  
Código montagem **CSM11**  
Para deslocações  
consultar pág. 373

## ACABADOS METÁLICOS ACABAMENTOS METÁLICOS



BLANCO  
BRANCO



PLATA BRILLO  
PRATA BRILHO



PLATA MATE  
PRATA MATE



# TP5 | ANGULAR

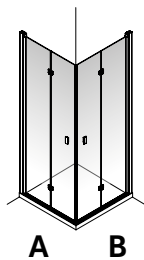

PERFIL BLANCO - PLATA BRILLO - PLATA MATE  
 PERFIL BRANCO - PRATA BRILHO - PRATA MATE

		<b>A mm</b>	
		600-750	751-1000
VIDRIO VIDRO	Transparente	391 €	424 €
	Affumicato, Bronce, Mate, Transp. decorado	489 €	530 €
	Affumicato decorado Bronce decorado Nuevos / Novos decorados *	547 €	594 €

		<b>B mm</b>	
		600-750	751-1000
VIDRIO VIDRO	Transparente	391 €	424 €
	Affumicato, Bronce, Mate, Transp. decorado	489 €	530 €
	Affumicato decorado Bronce decorado Nuevos / Novos decorados *	547 €	594 €

Para precio total, sumar ambos lados A y B.  
 Para o preço total, some os dois lados A e B.

\* Para serigrafías digitales confirmar precio con ATC. / Para serigrafias digitais confirmar preço com ATC.

## VIDRIO Y DECORADO VIDRO E DECORADO



## NUEVOS DECORADOS NOVOS DECORADOS



# technic

TSC · TSX | MAMPARA CUARTOCIRCULAR: 2 PUERTAS BATIENTES Y 2 FIJOS  
 DIVISÓRIA QUARTO-CIRCULAR: 2 PORTAS DE ABRIR E 2 FIXOS

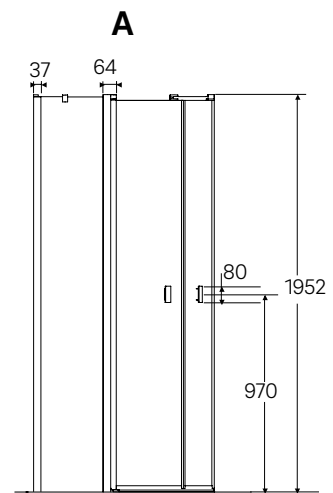

Dimensiones en mm.  
 Dimensões em mm.



VIDRIO TEMPLADO  
 VIDRO TEMPERADO  
**6 MM**



COMPENSACIÓN A CADA LADO  
 COMPENSAÇÃO A CADA LADO  
**15 MM**



ALTURA MODELO DUCHA  
 ALTURA MODELO DUCHE  
**1950 MM**  
 NO SE FABRICA A OTRAS ALTURAS  
 NÃO FABRICA EM OUTRAS ALTURAS



REVERSIBLE  
 REVERSÍVEL



MEDIDAS Y ALTURAS ESPECIALES  
 MEDIDAS E ALTURAS ESPECIAIS  
 (VER PÁG. / CONSULTA A PÁG. **372**)



TRATAMIENTO OPCIONAL (M)  
 TRATAMENTO OPCIONAL (M)  
**47,50 €**



PLEGABLE  
 FOLDABLE



MONTAJE  
 MONTAJEM  
**125 € \***

\* Precio recomendado  
 Código montaje **CSM11**  
 Para desplazamientos  
 consultar pág. **373**

\* Preço recomendado  
 Código montagem **CSM11**  
 Para deslocações  
 consultar pág. **373**

## ACABADOS METÁLICOS ACABAMENTOS METÁLICOS



BLANCO  
 BRANCO



PLATA BRILLO  
 PRATA BRILHO



PLATA MATE  
 PRATA MATE

## TSC | RADIO RAIO 500

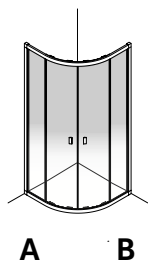

PERFIL BLANCO - PLATA BRILLO - PLATA MATE  
 PERFIL BRANCO - PRATA BRILHO - PRATA MATE

		A mm	
		700-900	901-1200
VIDRIO VIDRO	Transparente	541 €	575 €
	Mate, Transp. Pictor	676 €	719 €
ENTRADA MÍNIMA mm / ENTRADA MÍNIMO mm		650	650

		B mm	
		700-900	901-1200
VIDRIO VIDRO	Transparente	541 €	575 €
	Mate, Transp. Pictor	676 €	719 €
ENTRADA MÍNIMA mm / ENTRADA MÍNIMO mm		650	650

Para precio total, sumar ambos lados A y B.  
 Para o preço total, some os dois lados A e B.

## TSX | RADIO RAIO 550

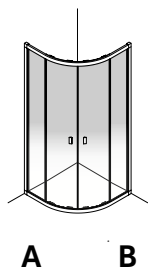

PERFIL BLANCO - PLATA BRILLO - PLATA MATE  
 PERFIL BRANCO - PRATA BRILHO - PRATA MATE

		A mm	
		750-900	901-1200
VIDRIO VIDRO	Transparente	541 €	575 €
	Mate, Transp. Pictor	676 €	719 €
ENTRADA MÍNIMA mm / ENTRADA MÍNIMO mm		715	715

		B mm	
		750-900	901-1200
VIDRIO VIDRO	Transparente	541 €	575 €
	Mate, Transp. Pictor	676 €	719 €
ENTRADA MÍNIMA mm / ENTRADA MÍNIMO mm		715	715

Para precio total, sumar ambos lados A y B.  
 Para o preço total, some os dois lados A e B.

### VIDRIO Y DECORADO VIDRO E DECORADO

TRANSP.



SIN DECORADO



PICTOR

MATE



SIN DECORADO



# Puertas de paso

Portas de paso





Frontal de la puerta corredera con guía superior cerrada, quedando totalmente ocultos los sistemas de rodamiento y de regulación. Diseñado para soportar un uso intensivo.

---

Frente da porta de correr com guia superior fechada, ficando totalmente ocultos os sistemas de rolamento e regulação. Concebido para suportar uma utilização intensiva.













Puertas de paso que conectan espacios interiores.  
Elegante acabado del vidrio en bronce, siguiendo las  
últimas tendencias. También disponible con vidrio  
transparente, mateado o affumicato.

Portas de acesso que ligam espaços interiores.  
Elegante acabamento do vidro em bronze, seguindo  
as últimas tendências. Também dispõe com vidro  
transparente, mate ou fumado.



Cierre de seguridad Soft-Close, con amortiguador, incluido. Frena la inercia de movimiento de la puerta mediante un mecanismo hidráulico consiguiendo un cierre suave y progresivo.

---

Fecho de segurança Soft-Close, com amortecedor. Trava a inércia de movimento da porta mediante um mecanismo hidráulico conseguindo um fecho suave e progressivo.



Nuevo acabado de la guía en negro mate que subraya y enfatiza las líneas de diseño de la mampara.

---

Novo acabamento da guia de negro mate que realça e enfatiza as linhas do design da divisória.



Siguiendo las últimas tendencias, se presenta el color bronce en el vidrio tintado como una novedad. También disponible en transparente y affumicato.

---

Seguindo as últimas tendencias, apresentamos a cor bronze no vidro pintado como uma novidade. Também disponível em transparente e fumado





Stock

Info

# suite

SPP | PUERTA DE ACCESO CORREDERA: 1 HOJA A PARED  
 PORTA DO ACESSO DE CORRER: 1 FOLHA A PAREDE

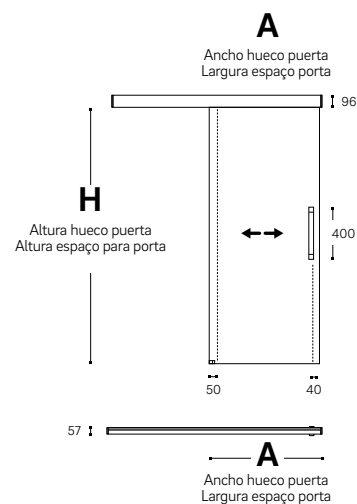

Dimensiones en mm.  
 Dimensões em mm.

20 mm de distancia del cristal  
 con respecto a la pared.  
 20 mm de distancia do vidro à parede.



VIDRIO TEMPLADO  
 VIDRO TEMPERADO  
**8** MM



SOFT-CLOSE  
 SOFTCLOSE



TIRADOR  
 PUXADOR  
**400-700** MM



Para acabados de vidrio mate o con serigrafía: salvo indicación en sentido contrario, la cara serigrafiada o mateada será la cara que coincide con la tapa de la guía.

Para acabamentos do vidro mate ou com decorado: a menos que seja indicado o contrário, a cara mate mate ou decorada será a correspondente com a tapa da guia.



MEDIDAS Y ALTURAS ESPECIALES  
 MEDIDAS E ALTURAS ESPECIAIS  
 (VER PÁG. / CONSULTA A PÁG. **372**)



MONTAJE  
 MONTAJEM  
**110** € \*

\* Precio recomendado  
 Código montaje **CSM08**  
 Para desplazamientos  
 consultar pág. **373**

\* Preço recomendado  
 Código montagem **CSM08**  
 Para deslocações  
 consultar pág. **373**

## ACABADOS METÁLICOS ACABAMENTOS METÁLICOS



BRILLO  
 BRILHO



NEGRO MATE  
 PRETO MATE



INOX MATE  
 INOX MATE

## TIRADOR PUXADOR



400 MM  
 500 MM  
 600 MM  
 700 MM

# SPP

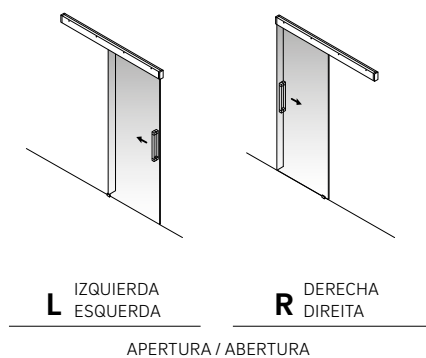

Estos precios incluyen un tirador de 400mm en el mismo acabado que el perfil de la mampara.  
 Estes valores incluem um puxador de 400mm do mesmo acabamento do perfil da divisória.

## A

600-800 mm		PERFIL BRILLO PERFIL BRILHO	PERFIL INOX MATE/NEGRO MATE PERFIL INOX MATE/PRETO MATE		
ALTURA (H) mm / ALTURA (H) mm		2100-2200	2201-2500	2100-2200	2201-2500
VIDRIO VIDRO	Transparente	780 €	858 €	915 €	1.010 €
	Affumicato, Bronce, Mate, Transp. decorado	938 €	1.032 €	1.100 €	1.213 €
	Affumicato decorado Bronce decorado Nuevos / Novos decorados *	1.055 €	1.162 €	1.240 €	1.363 €

## A

801-990 mm		PERFIL BRILLO PERFIL BRILHO	PERFIL INOX MATE/NEGRO MATE PERFIL INOX MATE/PRETO MATE		
ALTURA (H) mm / ALTURA (H) mm		2100-2200	2201-2500	2100-2200	2201-2500
VIDRIO VIDRO	Transparente	893 €	983 €	1.050 €	1.151 €
	Affumicato, Bronce, Mate, Transp. decorado	1.072 €	1.179 €	1.263 €	1.381 €
	Affumicato decorado Bronce decorado Nuevos / Novos decorados *	1.207 €	1.330 €	1.419 €	1.555 €

TIRADOR PARA PUERTA mm PUXADOR PARA PORTA mm	400	500	600	700
BRILLO BRILHO	Incluido / Incluso	+17 €	+33 €	+50 €
NEGRO MATE / INOX MATE PRETO MATE / INOX MATE	Incluido / Incluso	+17 €	+33 €	+50 €

\* Para serigrafías digitales confirmar precio con ATC. / Para serigrafias digitais confirmar preço com ATC.

### VIDRIO Y DECORADO VIDRO E DECORADO



### NUEVOS DECORADOS NOVOS DECORADOS



# suite

SPD | PUERTA DE ACCESO: 2 PUERTAS CORREDERAS A PARED  
 PORTA DO ACESSO: 2 PORTAS DE CORRER A PAREDE

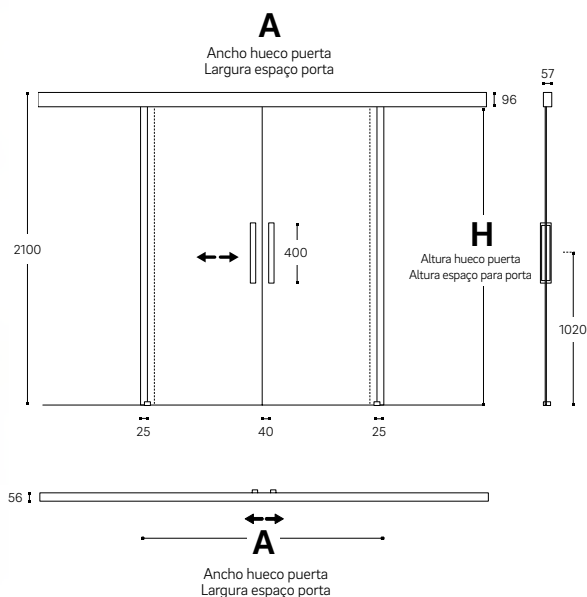

Dimensiones en mm.  
 Dimensões em mm.

20 mm de distancia del cristal  
 con respecto a la pared.  
 20 mm de distancia do vidro à parede.



VIDRIO TEMPLADO  
 VIDRO TEMPERADO  
**8** MM



SOFT-CLOSE  
 SOFTCLOSE



TIRADOR  
 PUXADOR  
**400-700** MM



**NOTA**

Para acabados de vidrio mate o con serigrafía: salvo indicación en sentido contrario, La cara serigrafiada o mateada será la cara que coincide con la tapa de la guía.

Para acabamentos do vidro mate ou com decorado: a menos que seja indicado o contrário, a cara mate mate ou decorada será a correspondente com a tapa da guia.



MEDIDAS Y ALTURAS ESPECIALES  
 MEDIDAS E ALTURAS ESPECIAIS  
 (VER PÁG. / CONSULTA A PÁG. **372**)



MONTAJE  
 MONTAJEM  
**120** € \*

\* Precio recomendado  
 Código montaje **CSM10**  
 Para desplazamientos  
 consultar pág. **373**

\* Preço recomendado  
 Código montagem **CSM10**  
 Para deslocações  
 consultar pág. **373**

## ACABADOS METÁLICOS ACABAMENTOS METÁLICOS



BRILLO  
 BRILHO



NEGRO MATE  
 PRETO MATE



INOX MATE  
 INOX MATE

## TIRADOR PUXADOR



400 MM  
 500 MM  
 600 MM  
 700 MM

## SPD | FRONTAL

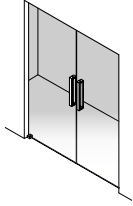

Estos precios incluyen 2 tiradores de 400mm en el mismo acabado que el perfil de la mampara.  
Estos valores incluyen 2 puxadores de 400mm do mesmo acabamento do perfil da divisória.

### A

900-1200 mm		PERFIL BRILLO PERFIL BRILHO		PERFIL INOX MATE/NEGRO MATE PERFIL INOX MATE/PRETO MATE	
ALTURA (H) mm / ALTURA (H) mm		2100-2200	2201-2500	2100-2200	2201-2500
VIDRIO VIDRO	Transparente	1.263 €	1.392 €	1.482 €	1.634 €
	Affumicato, Bronce, Mate, Transp. decorado	1.515 €	1.672 €	1.779 €	1.964 €
	Affumicato decorado Bronce decorado Nuevos / Novos decorados *	1.707 €	1.880 €	2.004 €	2.206 €

### A

1201-1550 mm		PERFIL BRILLO PERFIL BRILHO		PERFIL INOX MATE/NEGRO MATE PERFIL INOX MATE/PRETO MATE	
ALTURA (H) mm / ALTURA (H) mm		2100-2200	2201-2500	2100-2200	2201-2500
VIDRIO VIDRO	Transparente	1.432 €	1.578 €	1.678 €	1.846 €
	Affumicato, Bronce, Mate, Transp. decorado	1.718 €	1.897 €	2.015 €	2.217 €
	Affumicato decorado Bronce decorado Nuevos / Novos decorados *	1.936 €	2.132 €	2.268 €	2.497 €

TIRADOR PARA PUERTAS (2 UDS) mm PUXADOR PARA PORTAS (2 UDS) mm	400	500	600	700
BRILLO BRILHO	Incluido / Incluso	+33 €	+66 €	+99 €
NEGRO MATE / INOX MATE PRETO MATE / INOX MATE	Incluido / Incluso	+33 €	+66 €	+99 €

\* Para serigrafías digitales confirmar precio con ATC. / Para serigrafias digitais confirmar preço com ATC.

#### VIDRIO Y DECORADO VIDRO E DECORADO

TRANSP.	AFFUMICATO	BRONCE	MATE
SIN DECORADO	SIN DECORADO	SIN DECORADO	SIN DECORADO
PICTOR	PICTOR	PICTOR	

#### NUEVOS DECORADOS NOVOS DECORADOS

SERIGRAFÍAS ESPECIALES		SERIGRAFÍAS DIGITALES	
MIRAI	WETLANDS	BAMBOO	WAVE
GRID		FOG	

# suite

SP2 | PUERTA DE ACCESO CORREDERA: 1 PUERTA Y 1 FIJO ENTRE PAREDES  
 PORTA DO ACESSO DE CORRER: 1 PORTA E 1 FIXO ENTRE PAREDE

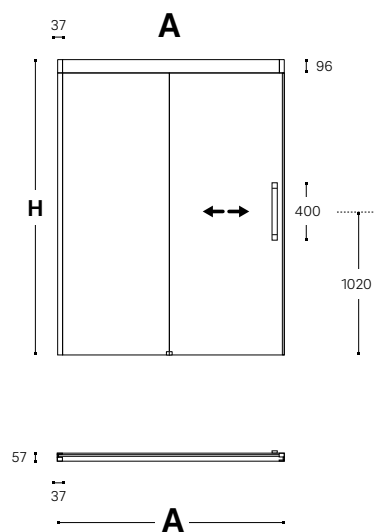

Dimensiones en mm.  
 Dimensões em mm.



VIDRIO TEMPLADO  
 VIDRO TEMPERADO  
**8 MM**



COMPENSACIÓN A CADA LADO  
 COMPENSAÇÃO A CADA LADO  
**15 MM**



SOFT-CLOSE  
 SOFTCLOSE



Para acabados de vidrio mate o con serigrafía: salvo indicación en sentido contrario. La cara serigrafiada o mateada será la cara que coincide con la tapa de la guía.

Para acabamentos do vidro mate ou com decorado: a menos que seja indicado o contrário, a cara mate mate ou decorada será a correspondente com a tapa da guia.



MEDIDAS Y ALTURAS ESPECIALES  
 MEDIDAS E ALTURAS ESPECIAIS  
 (VER PÁG. / CONSULTA PÁG. **372**)



TIRADOR  
 PUXADOR  
**400-700 MM**



MONTAJE  
 MONTAJEM  
**120 € \***

\* Precio recomendado  
 Código montaje **CSM10**  
 Para desplazamientos  
 consultar pág. **373**

\* Preço recomendado  
 Código montagem **CSM10**  
 Para deslocações  
 consultar pág. **373**

## ACABADOS METÁLICOS ACABAMENTOS METÁLICOS



BRILLO  
 BRILHO



NEGRO MATE  
 PRETO MATE



INOX MATE  
 INOX MATE

## TIRADOR PUXADOR



400 MM  
 500 MM  
 600 MM  
 700 MM

## SP2 | FRONTAL

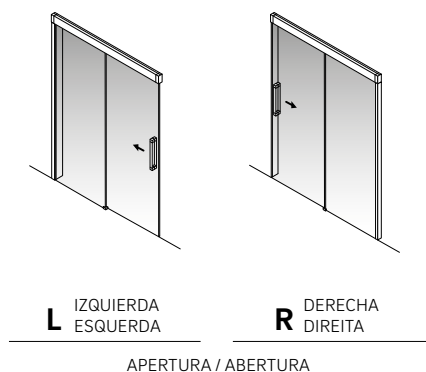

### A

1200-1400 mm		PERFIL BRILLO PERFIL BRILHO	PERFIL INOX MATE/NEGRO MATE PERFIL INOX MATE/PRETO MATE
ALTURA (H) mm / ALTURA (H) mm		2100-2200	2201-2500
VIDRIO VIDRO	Transparente	1.039 €	1.144 €
	Affumicato, Bronce, Mate, Transp. decorado	1.246 €	1.375 €
	Affumicato decorado Bronce decorado Nuevos / Novos decorados *	1.403 €	1.544 €

### A

1401-1600 mm		PERFIL BRILLO PERFIL BRILHO	PERFIL INOX MATE/NEGRO MATE PERFIL INOX MATE/PRETO MATE
ALTURA (H) mm / ALTURA (H) mm		2100-2200	2201-2500
VIDRIO VIDRO	Transparente	1.133 €	1.251 €
	Affumicato, Bronce, Mate, Transp. decorado	1.363 €	1.504 €
	Affumicato decorado Bronce decorado Nuevos / Novos decorados *	1.532 €	1.689 €

### A

1601-1800 mm		PERFIL BRILLO PERFIL BRILHO	PERFIL INOX MATE/NEGRO MATE PERFIL INOX MATE/PRETO MATE
ALTURA (H) mm / ALTURA (H) mm		2100-2200	2201-2500
VIDRIO VIDRO	Transparente	1.229 €	1.352 €
	Affumicato, Bronce, Mate, Transp. decorado	1.476 €	1.627 €
	Affumicato decorado Bronce decorado Nuevos / Novos decorados *	1.661 €	1.830 €

### A

1801-2000 mm		PERFIL BRILLO PERFIL BRILHO	PERFIL INOX MATE/NEGRO MATE PERFIL INOX MATE/PRETO MATE
ALTURA (H) mm / ALTURA (H) mm		2100-2200	2201-2500
VIDRIO VIDRO	Transparente	1.291 €	1.419 €
	Affumicato, Bronce, Mate, Transp. decorado	1.549 €	1.705 €
	Affumicato decorado Bronce decorado Nuevos / Novos decorados *	1.745 €	1.924 €

MEDIDA TIRADOR PARA PUERTA mm MEDIDA PUXADOR PARA PORTA mm	400	500	600	700
BRILLO BRILHO	Incluido / Incluso	+17 €	+33 €	+50 €
NEGRO MATE / INOX MATE PRETO MATE / INOX MATE	Incluido / Incluso	+17 €	+33 €	+50 €

Estos precios incluyen un tirador de 400mm en el mismo acabado que el perfil de la mampara.

Estes valores incluem um puxador de 400mm do mesmo acabamento do perfil da divisória.

\* Para serigrafías digitales confirmar precio con ATC. / Para serigrafías digitais confirmar preço com ATC.

#### VIDRIO Y DECORADO VIDRO E DECORADO



#### NUEVOS DECORADOS NOVOS DECORADOS



# suite

SP4 | PUERTA DE ACCESO CORREDERA: 2 PUERTAS Y 2 FIJOS ENTRE PAREDES  
 PORTA DO ACESSO DE CORRER: 2 PORTAS E 2 FIXOS ENTRE PAREDE

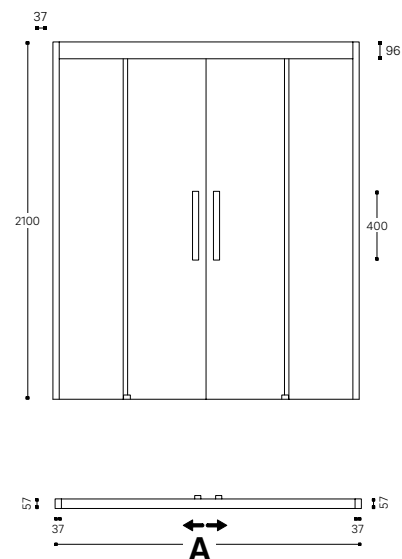

Dimensiones en mm.  
 Dimensões em mm.



VIDRIO TEMPLADO  
 VIDRO TEMPERADO  
**8 MM**



COMPENSACIÓN A CADA LADO  
 COMPENSAÇÃO A CADA LADO  
**15 MM**



SOFT-CLOSE  
 SOFTCLOSE  
 PARA ANCHO SUPERIOR A  
 PARA LARGURA SUPERIOR A  
**2000 MM**



Para acabados de vidrio mate o con serigrafía: salvo indicación en sentido contrario. La cara serigrafiada o mateada será la cara que coincide con la tapa de la guía.  
 Para acabamentos do vidro mate ou com decorado: a menos que seja indicado o contrário, a cara mate mate ou decorada será a correspondente com a tapa da la guía.



MEDIDAS Y ALTURAS ESPECIALES  
 MEDIDAS E ALTURAS ESPECIAIS  
 (VER PÁG. / CONSULTA A PÁG. **372**)



TIRADOR  
 PUXADOR  
**400-700 MM**



MONTAJE  
 MONTAJEM  
**130 € \***

\* Precio recomendado  
 Código montaje **CSM12**  
 Para desplazamientos  
 consultar pág. **373**

\* Preço recomendado  
 Código montagem **CSM12**  
 Para deslocações  
 consultar pág. **373**

## ACABADOS METÁLICOS ACABAMENTOS METÁLICOS



BRILLO  
 BRILHO



NEGRO MATE  
 PRETO MATE



INOX MATE  
 INOX MATE

## TIRADOR PUXADOR



400 MM  
 500 MM  
 600 MM  
 700 MM



# SP4 | FRONTAL

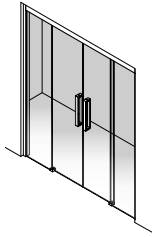

## A

1400-1600 mm		PERFIL BRILLO PERFIL BRILHO		PERFIL INOX MATE/NEGRO MATE PERFIL INOX MATE/PRETO MATE	
ALTURA (H) mm / ALTURA (H) mm		2100-2200	2201-2500	2100-2200	2201-2500
VIDRIO VIDRO	Transparente	1.397 €	1.538 €	1.639 €	1.808 €
	Affumicato, Bronce, Mate, Transp. decorado	1.678 €	1.846 €	1.971 €	2.172 €
	Affumicato decorado Bronce decorado Nuevos / Novos decorados *	1.891 €	2.083 €	2.217 €	2.441 €

## A

1601-1800 mm		PERFIL BRILLO PERFIL BRILHO		PERFIL INOX MATE/NEGRO MATE PERFIL INOX MATE/PRETO MATE	
ALTURA (H) mm / ALTURA (H) mm		2100-2200	2201-2500	2100-2200	2201-2500
VIDRIO VIDRO	Transparente	1.499 €	1.650 €	1.757 €	1.936 €
	Affumicato, Bronce, Mate, Transp. decorado	1.803 €	1.987 €	2.110 €	2.324 €
	Affumicato decorado Bronce decorado Nuevos / Novos decorados *	2.027 €	2.233 €	2.374 €	2.615 €

## A

1801-2000 mm		PERFIL BRILLO PERFIL BRILHO		PERFIL INOX MATE/NEGRO MATE PERFIL INOX MATE/PRETO MATE	
ALTURA (H) mm / ALTURA (H) mm		2100-2200	2201-2500	2100-2200	2201-2500
VIDRIO VIDRO	Transparente	1.600 €	1.763 €	1.875 €	2.065 €
	Affumicato, Bronce, Mate, Transp. decorado	1.920 €	2.116 €	2.251 €	2.481 €
	Affumicato decorado Bronce decorado Nuevos / Novos decorados *	2.161 €	2.380 €	2.532 €	2.789 €

## A

2001-2400 mm		PERFIL BRILLO PERFIL BRILHO		PERFIL INOX MATE/NEGRO MATE PERFIL INOX MATE/PRETO MATE	
ALTURA (H) mm / ALTURA (H) mm		2100-2200	2201-2500	2100-2200	2201-2500
VIDRIO VIDRO	Transparente	1.701 €	1.875 €	1.993 €	2.195 €
	Affumicato, Bronce, Mate, Transp. decorado	2.043 €	2.251 €	2.391 €	2.632 €
	Affumicato decorado Bronce decorado Nuevos / Novos decorados *	2.301 €	2.235 €	2.693 €	2.963 €



SOFT-CLOSE  
SOFTCLOSE

## A

2401-2800 mm		PERFIL BRILLO PERFIL BRILHO		PERFIL INOX MATE/NEGRO MATE PERFIL INOX MATE/PRETO MATE	
ALTURA (H) mm / ALTURA (H) mm		2100-2200	2201-2500	2100-2200	2201-2500
VIDRIO VIDRO	Transparente	1.802 €	1.987 €	2.110 €	2.324 €
	Affumicato, Bronce, Mate, Transp. decorado	2.166 €	2.385 €	2.537 €	2.794 €
	Affumicato decorado Bronce decorado Nuevos / Novos decorados *	2.436 €	2.682 €	2.851 €	3.137 €



SOFT-CLOSE  
SOFTCLOSE

A partir de 2400mm de ancho, las mamparas tendrán un máximo de apertura limitado a 1200mm.

De 2400mm de largura, as divisorias terão uma abertura máxima limitada a 1200mm.

Estos precios incluyen 2 tiradores de 400mm en el mismo acabado que el perfil de la mampara.

Estos valores incluyen 2 puxadores de 400mm do mesmo acabamento do perfil da divisória.

TIRADOR PARA 2 PUERTAS (2 UDS) mm PUXADOR PARA 2 PORTAS (2 UDS) mm	400	500	600	700
BRILLO BRILHO	Incluido / Incluso	+33 €	+66 €	+99 €
NEGRO MATE / INOX MATE PRETO MATE / INOX MATE	Incluido / Incluso	+33 €	+66 €	+99 €

\* Para serigrafías digitales confirmar precio con ATC. / Para serigrafias digitais confirmar preço com ATC.

### VIDRIO Y DECORADO VIDRO E DECORADO

TRANSP.	AFFUMICATO	BRONCE	MATE
SIN DECORADO	SIN DECORADO	SIN DECORADO	SIN DECORADO
PICTOR	PICTOR	PICTOR	

### NUEVOS DECORADOS NOVOS DECORADOS

SERIGRAFÍAS ESPECIALES		SERIGRAFÍAS DIGITALES	
MIRAI	WETLANDS	BAMBOO	WAVE
GRID		FOG	

# suite

SPB | PUERTA DE ACCESO BATIENTE: 1 PUERTA ENTRE PAREDES  
 PORTA DO ACESSO DE ABRIR: 1 PORTA ENTRE PAREDE

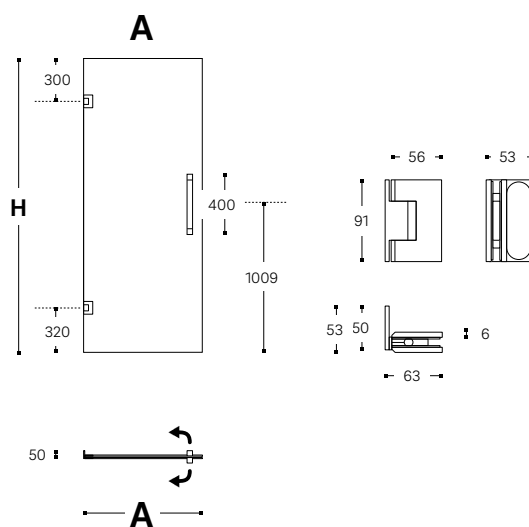

Dimensiones en mm.  
 Dimensões em mm.



VIDRIO TEMPLADO  
 VIDRO TEMPERADO  
**8** MM



TIRADOR  
 PUXADOR  
**400-700** MM



BISAGRAS CROMADAS  
 CON POSICIONADOR **90-180°**  
 DOBRADIÇAS CROMADAS  
 CON POSIÇÃOADOR **90-180°**



MEDIDAS Y ALTURAS ESPECIALES  
 MEDIDAS E ALTURAS ESPECIAIS  
 (VER PÁG. / CONSULTA A PÁG. **372**)



MONTAJE  
 MONTAJEM  
**110** € \*

- \* Precio recomendado  
 Código montaje **CSM08**  
 Para desplazamientos  
 consultar pág. **373**
- \* Preço recomendado  
 Código montagem **CSM08**  
 Para deslocações  
 consultar pág. **373**

## ACABADOS METÁLICOS ACABAMENTOS METÁLICOS



BRILLO  
 BRILHO



NEGRO MATE  
 PRETO MATE



INOX MATE  
 INOX MATE

## TIRADOR PUXADOR



400 MM  
 500 MM  
 600 MM  
 700 MM

## SPB | FRONTAL

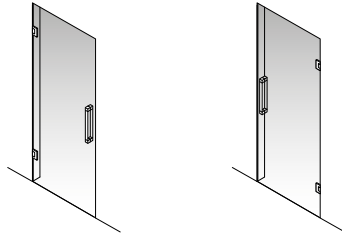

**L** IZQUIERDA  
ESQUERDA

**R** DERECHA  
DIREITA

FIJACIÓN / FIXAÇÃO

### A

#### 600-700 mm

ALTURA (H) mm / ALTURA (H) mm		PERFIL BRILLO PERFIL BRILHO	PERFIL NEGRO MATE / PERFIL INOX MATE PERFIL PRETO MATE / PERFIL INOX MATE	2100-2200	2201-2500	2100-2200	2201-2500
VIDRIO VIDRO	Transparente	522 €		578 €		601 €	668 €
	Affumicato, Bronce, Mate, Transp. decorado	629 €		696 €		724 €	802 €
	Affumicato decorado Bronce decorado Nuevos / Novos decorados *	708 €		786 €		814 €	904 €

### A

#### 701-800 mm

ALTURA (H) mm / ALTURA (H) mm		PERFIL BRILLO PERFIL BRILHO	PERFIL NEGRO MATE / PERFIL INOX MATE PERFIL PRETO MATE / PERFIL INOX MATE	2100-2200	2201-2500	2100-2200	2201-2500
VIDRIO VIDRO	Transparente	550 €		612 €		634 €	708 €
	Affumicato, Bronce, Mate, Transp. decorado	663 €		735 €		764 €	853 €
	Affumicato decorado Bronce decorado Nuevos / Novos decorados *	746 €		831 €		858 €	960 €

### A

#### 801-900 mm

ALTURA (H) mm / ALTURA (H) mm		PERFIL BRILLO PERFIL BRILHO	PERFIL NEGRO MATE / PERFIL INOX MATE PERFIL PRETO MATE / PERFIL INOX MATE	2100-2200	2201-2500	2100-2200	2201-2500
VIDRIO VIDRO	Transparente	590 €		652 €		679 €	752 €
	Affumicato, Bronce, Mate, Transp. decorado	708 €		786 €		820 €	904 €
	Affumicato decorado Bronce decorado Nuevos / Novos decorados *	797 €		882 €		920 €	1.016 €

### A

#### 901-1000 mm

ALTURA (H) mm / ALTURA (H) mm		PERFIL BRILLO PERFIL BRILHO	PERFIL NEGRO MATE / PERFIL INOX MATE PERFIL PRETO MATE / PERFIL INOX MATE	2100-2200	2201-2500	2100-2200	2201-2500
VIDRIO VIDRO	Transparente	629 €		696 €		724 €	802 €
	Affumicato, Bronce, Mate, Transp. decorado	758 €		836 €		871 €	965 €
	Affumicato decorado Bronce decorado Nuevos / Novos decorados *	853 €		943 €		983 €	1.088 €

Estos precios incluyen 2 tiradores de 400mm en el mismo acabado que el perfil de la mampara.  
Estos valores incluyen 2 puxadores de 400mm do mesmo acabamento do perfil da divisória.

TIRADOR PARA PUERTA mm PUXADOR PARA PORTA mm	400	500	600	700
BRILLO BRILHO	Incluido / Incluso	+17 €	+33 €	+50 €
NEGRO MATE / INOX MATE PRETO MATE / INOX MATE	Incluido / Incluso	+17 €	+33 €	+50 €

\* Para serigrafías digitales confirmar precio con ATC. / Para serigrafias digitais confirmar preço com ATC.

#### VIDRIO Y DECORADO VIDRO E DECORADO

TRANSP.	AFFUMICATO	BRONCE	MATE
SIN DECORADO	SIN DECORADO	SIN DECORADO	SIN DECORADO
PICTOR	PICTOR	PICTOR	

#### NUEVOS DECORADOS NOVOS DECORADOS

SERIGRAFÍAS ESPECIALES	SERIGRAFÍAS DIGITALES
MIRAI	BAMBOO
WETLANDS	WAVE
GRID	FOG



# Soluciones especiales

Soluções especiais





Acabado en negro mate en los modelos batientes y Walk-in de la colección Suite.

Acabamento em preto mate nos modelos de porta de abrir e Walk-in da coleção Suite.















División de dos espacios (zona de inodoro y zona de ducha) con una única puerta de acceso corredera.

Divisão de dois espaços ( zona sanitários e zona de duche) com um aúnica porta de acesso de correr.





Stock

Info







Solución en forma de T que permite separar la ducha de la zona más privada del cuarto de baño. Puertas de acceso correderas independientes para cada una de las zonas.

Solução em forma de T que permite separar o duche da zona mais privada do quarto de banho. Portas de correr de acesso independentes para cada uma das zonas.

# suite

## SOLUCIÓN ST1 | PUERTA DE ACCESO CORREDERA + FIJO EN "T" PORTA DO ACCESO DE CORRER + FIXO EN "T"

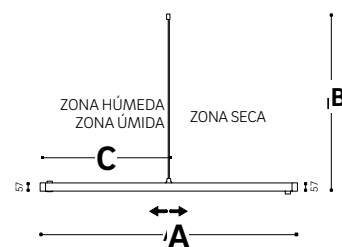
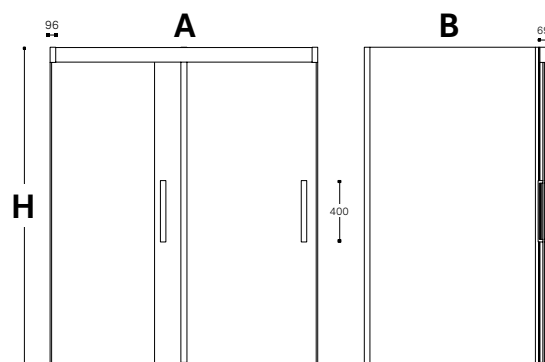
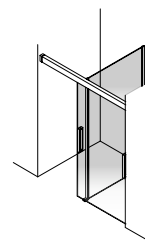

Dimensiones en mm.  
Dimensões em mm.

MODELO APTO PARA PLATOS DE DUCHA ENRASADOS  
MODELO APROPRIADO PARA BASES DE DUCHA NIVELADAS



VIDRIO TEMPLADO  
VIDRO TEMPERADO  
**8** MM



COMPENSACIÓN A CADA LADO  
Y LATERAL **15** MM  
COMPENSAÇÃO A CADA LADO  
E LATERAL **15** MM



EN ZONA HÚMEDA  
EM ZONA ÚMIDA



TIRADOR  
PUXADOR  
**400-700** MM



MONTAJE  
MONTAJEM  
**170 € \***

\* Precio recomendado  
Código montaje **CSM20**  
Para desplazamientos  
consultar pág. **373**

\* Preço recomendado  
Código montagem **CSM20**  
Para deslocações  
consultar pág. **373**

Se adjunta hoja de  
instalación personalizada  
Folha de instalação  
personalizada anexada



MEDIDAS Y ALTURAS ESPECIALES  
MEDIDAS E ALTURAS ESPECIAIS  
**HASTA / ATÉ 2500** MM  
(VER PÁG. / CONSULTA A PÁG. **372**)



SOFT-CLOSE  
SOFTCLOSE



DEBE INDICARNOS LA MEDIDA **C**. EL FRONTAL  
SIEMPRE SERA UNA REFERENCIA ESPECIAL.  
DEBE INDICARNOS LA MEDIDA **C**. EL FRONTAL  
SIEMPRE SERA UNA REFERENCIA ESPECIAL.

### ACABADOS METÁLICOS ACABAMENTOS METÁLICOS



BRILLO  
BRILHO



NEGRO MATE  
PRETO MATE



INOX MATE  
INOX MATE

### TIRADOR PUXADOR



400 MM  
500 MM  
600 MM  
700 MM

## SOLUCIÓN ST1 | FRONTAL

A mm		PERFIL BRILLO PERFIL BRILHO							
		1200-1400 mm		1401-1600 mm		1601-1800 mm		1801-2000 mm	
MEDIDAS ALTURA (H) mm		2100-2200	2201-2500	2100-2200	2201-2500	2100-2200	2201-2500	2100-2200	2201-2500
VIDRIO VIDRO	Transparente	1.073 €	1.185 €	1.168 €	1.285 €	1.263 €	1.392 €	1.359 €	1.499 €
	Affumicato, Bronce, Mate, Transp. decorado	1.291 €	1.403 €	1.403 €	1.544 €	1.515 €	1.667 €	1.549 €	1.707 €
	Affumicato decorado, Bronce decorado Nuevos / Novos decorados *	1.448 €	1.578 €	1.578 €	1.740 €	1.707 €	1.880 €	1.746 €	1.925 €

Estos precios incluyen 2 tiradores de 400mm en el mismo acabado que el perfil de la mampara.

Estos valores incluyen 2 puxadores de 400mm do mesmo acabamento do perfil da divisória.

MEDIDA TIRADORES PARA PUERTAS mm (2 UDS) MEDIDA PUXADORES PARA PORTAS mm (2 UDS)	400	500	600	700
BRILLO BRILHO	Incluido / Incluso	+33 €	+66 €	+99 €
INOX MATE / NEGRO MATE INOX MATE / PRETO MATE	Incluido / Incluso	+33 €	+66 €	+99 €

A mm		INOX MATE / NEGRO MATE INOX MATE / PRETO MATE							
		1200-1400 mm		1401-1600 mm		1601-1800 mm		1801-2000 mm	
MEDIDAS ALTURA (H) mm		2100-2200	2201-2500	2100-2200	2201-2500	2100-2200	2201-2500	2100-2200	2201-2500
VIDRIO VIDRO	Transparente	1.258 €	1.386 €	1.370 €	1.510 €	1.482 €	1.634 €	1.594 €	1.757 €
	Affumicato, Bronce, Mate, Transp. decorado	1.510 €	1.661 €	1.645 €	1.813 €	1.779 €	1.958 €	1.914 €	2.110 €
	Affumicato decorado, Bronce decorado Nuevos / Novos decorados *	1.701 €	1.875 €	1.852 €	2.038 €	2.004 €	2.206 €	2.155 €	2.374 €

## SOLUCIÓN SL1 | FIJO ENT

B mm		PERFIL BRILLO PERFIL BRILHO					
		600-800 mm		801-1000 mm		1001-1200 mm	
MEDIDAS ALTURA (H) mm		2100-2200	2201-2500	2100-2200	2201-2500	2100-2200	2201-2500
VIDRIO VIDRO	Transparente	461 €	512 €	556 €	612 €	652 €	719 €
	Affumicato, Bronce, Mate, Transp. decorado	556 €	612 €	668 €	736 €	786 €	865 €
	Affumicato decorado, Bronce decorado Nuevos / Novos decorados *	624 €	691 €	753 €	831 €	882 €	972 €

B mm		INOX MATE / NEGRO MATE INOX MATE / PRETO MATE					
		600-800 mm		801-1000 mm		1001-1200 mm	
MEDIDAS ALTURA (H) mm		2100-2200	2201-2500	2100-2200	2201-2500	2100-2200	2201-2500
VIDRIO VIDRO	Transparente	539 €	596 €	652 €	719 €	764 €	842 €
	Affumicato, Bronce, Mate, Transp. decorado	652 €	719 €	786 €	865 €	921 €	1.017 €
	Affumicato decorado, Bronce decorado Nuevos / Novos decorados *	730 €	803 €	882 €	972 €	1.033 €	1.140 €

TOALLERO OPCIONAL PARA FIJO T mm ** TOALHEIRO OPCIONAL PARA FIJO T mm **	400	500	600	700
BRILLO BRILHO	+83 €	+94 €	+105 €	+121 €
INOX MATE / NEGRO MATE INOX MATE / PRETO MATE	+83 €	+94 €	+105 €	+121 €
MEDIDAS LATERAL mm	600-1200	700-1200	801-1200	1001-1200

\*\* Ver página 371 para más información de cómo solicitar el toallero opcional.

\*\* Consulta a página 371 para mais informações sobre como solicitar o toalheiro opcional.

\* Para serigrafías digitales confirmar precio con ATC. / Para serigrafias digitais confirmar preço com ATC.

### VIDRIO Y DECORADO VIDRO E DECORADO



### NUEVOS DECORADOS NOVOS DECORADOS



# suite

## SOLUCIÓN ST2 |

PUERTA DE ACCESO 1 PUERTA CORREDERA Y 1 FIJO ENTRE PAREDES + MAMPARA DE DUCHA CORREDERA: 1 PUERTA Y FIJO  
 PORTA DE ACCESO 1 PORTA DE CORRER E 1 FIXO ENTRE PAREDE + DIVISÓRIA DE DUCHE: 1 PORTA DE CORRER E 1 FIXO

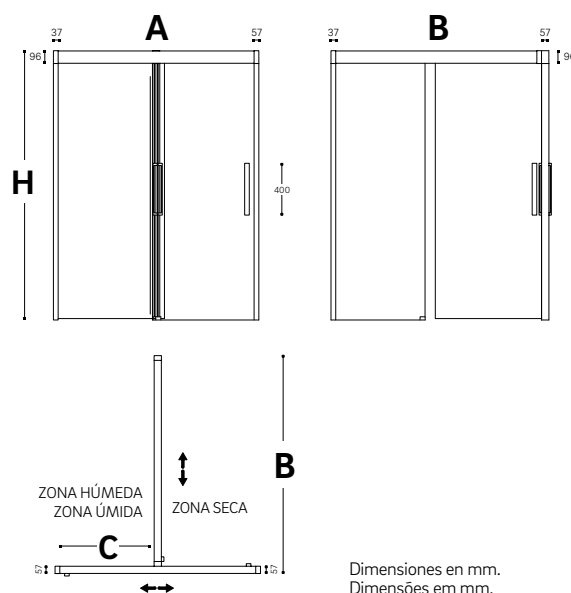
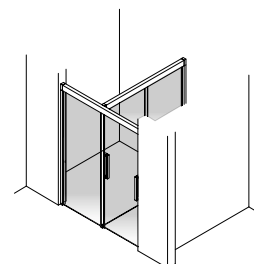

MODELO APTO PARA PLATOS DE DUCHA ENRASADOS  
 MODELO APROPRIADO PARA BASES DE DUCHA NIVELADAS



VIDRIO TEMPLADO  
 VIDRO TEMPERADO  
**8 MM**



COMPENSACIÓN A CADA LADO  
 COMPENSAÇÃO A CADA LADO  
**15 MM**



EN ZONA HÚMEDA  
 EM ZONA ÚMIDA



TIRADOR  
 PUXADOR  
**400-700 MM**



MONTAJE  
 MONTAJEM  
**200 € \***

\* Precio recomendado  
 Código montaje **CSM26**  
 Para desplazamientos  
 consultar pág. **373**

\* Preço recomendado  
 Código montagem **CSM26**  
 Para deslocações  
 consultar pág. **373**

Se adjunta hoja de  
 instalación personalizada  
 Folha de instalação  
 personalizada anexada



MEDIDAS Y ALTURAS ESPECIALES  
 MEDIDAS E ALTURAS ESPECIAIS  
**HASTA / ATÉ 2500 MM**  
 (VER PÁG. / CONSULTA A PÁG. **372**)



SOFT-CLOSE  
 SOFTCLOSE



DEBE INDICARNOS LA MEDIDA **C**. EL FRONTAL  
 SIEMPRE SERA UNA REFERENCIA ESPECIAL.  
 DEBE INDICARNOS LA MEDIDA **C**. EL FRONTAL  
 SIEMPRE SERA UNA REFERENCIA ESPECIAL.

### ACABADOS METÁLICOS ACABAMENTOS METÁLICOS



BRILLO  
 BRILHO



NEGRO MATE  
 PRETO MATE



INOX MATE  
 INOX MATE

### TIRADOR PUXADOR



400 MM  
 500 MM  
 600 MM  
 700 MM

## SOLUCIÓN ST2 | FRONTAL

A mm		PERFIL BRILLO PERFIL BRILHO							
		1200-1400 mm		1401-1600 mm		1601-1800 mm		1801-2000 mm	
MEDIDAS ALTURA (H) mm		2100-2200	2201-2500	2100-2200	2201-2500	2100-2200	2201-2500	2100-2200	2201-2500
VIDRIO VIDRO	Transparente	1.095 €	1.207 €	1.191 €	1.314 €	1.285 €	1.415 €	1.381 €	1.522 €
	Affumicato, Bronce, Mate, Transp. decorado	1.314 €	1.448 €	1.432 €	1.578 €	1.544 €	1.701 €	1.659 €	1.817 €
	Affumicato decorado, Bronce decorado Nuevos / Novos decorados *	1.482 €	1.634 €	1.611 €	1.774 €	1.740 €	1.914 €	1.856 €	2.037 €

A mm		INOX MATE / NEGRO MATE INOX MATE / PRETO MATE							
		1200-1400 mm		1401-1600 mm		1601-1800 mm		1801-2000 mm	
MEDIDAS ALTURA (H) mm		2100-2200	2201-2500	2100-2200	2201-2500	2100-2200	2201-2500	2100-2200	2201-2500
VIDRIO VIDRO	Transparente	1.285 €	1.415 €	1.397 €	1.538 €	1.504 €	1.656 €	1.616 €	1.779 €
	Affumicato, Bronce, Mate, Transp. decorado	1.544 €	1.701 €	1.678 €	1.846 €	1.808 €	1.993 €	1.942 €	2.139 €
	Affumicato decorado, Bronce decorado Nuevos / Novos decorados *	1.740 €	1.914 €	1.891 €	2.083 €	2.032 €	2.239 €	2.183 €	2.402 €

## SOLUCIÓN SL2 | CORREDERA T

B mm		PERFIL BRILLO PERFIL BRILHO							
		1200-1400 mm		1401-1600 mm		1601-1800 mm		1801-2000 mm	
MEDIDAS ALTURA (H) mm		2100-2200	2201-2500	2100-2200	2201-2500	2100-2200	2201-2500	2100-2200	2201-2500
VIDRIO VIDRO	Transparente	1.207 €	1.330 €	1.303 €	1.437 €	1.397 €	1.538 €	1.493 €	1.645 €
	Affumicato, Bronce, Mate, Transp. decorado	1.448 €	1.594 €	1.566 €	1.723 €	1.678 €	1.846 €	1.791 €	1.958 €
	Affumicato decorado, Bronce decorado Nuevos / Novos decorados *	1.634 €	1.802 €	1.763 €	1.942 €	1.891 €	2.083 €	2.020 €	2.215 €

B mm		INOX MATE / NEGRO MATE INOX MATE / PRETO MATE							
		1200-1400 mm		1401-1600 mm		1601-1800 mm		1801-2000 mm	
MEDIDAS ALTURA (H) mm		2100-2200	2201-2500	2100-2200	2201-2500	2100-2200	2201-2500	2100-2200	2201-2500
VIDRIO VIDRO	Transparente	1.415 €	1.560 €	1.527 €	1.683 €	1.639 €	1.808 €	1.752 €	1.931 €
	Affumicato, Bronce, Mate, Transp. decorado	1.701 €	1.875 €	1.835 €	2.020 €	1.971 €	2.172 €	2.105 €	2.318 €
	Affumicato decorado, Bronce decorado Nuevos / Novos decorados *	1.914 €	2.110 €	2.065 €	2.273 €	2.217 €	2.441 €	2.369 €	2.610 €

Estos precios incluyen un tirador de 400mm en el mismo acabado que el perfil de la mampara.

Estes valores incluem um puxador de 400mm do mesmo acabamento do perfil da divisória.

\*\* Ver página 371 para más información de cómo solicitar el toallero opcional.

\*\* Consulta a página 371 para mais informações sobre como solicitar o toalheiro opcional.

### TIRADOR PARA PUERTA DE ACCESO Y CORREDERA mm PUXADOR PARA PORTA DO ACCESO E PORTA DE CORRER mm

	400	500	600	700
BRILLO BRILHO	Incluido / Incluso	+17 €	+33 €	+50 €
INOX MATE / NEGRO MATE INOX MATE / PRETO MATE	Incluido / Incluso	+17 €	+33 €	+50 €

### TOALLERO OPCIONAL PARA LOS FIJOS mm \*\* TOALHEIRO OPCIONAL PARA OS FIXOS mm \*\*

	400	500	600	700
BRILLO BRILHO	+83 €	+94 €	+105 €	+116 €
INOX MATE / NEGRO MATE INOX MATE / PRETO MATE	+83 €	+94 €	+105 €	+116 €
MEDIDAS FRONTAL mm	1200-2000	1401-2000	1601-2000	1801-2000

\* Para serigrafías digitales confirmar precio con ATC. / Para serigrafías digitais confirmar preço com ATC.

### VIDRIO Y DECORADO VIDRO E DECORADO



### NUEVOS DECORADOS NOVOS DECORADOS



# suite

## SOLUCIÓN ST3

PUERTA DE ACCESO 2 PUERTAS CORREDERA Y UN FIJO CENTRAL + FIJO EN "T"  
 PORTA DO ACCESO DE 2 PORTAS DE CORRER E 1 FIXO CENTRAL + FIXO EN "T"

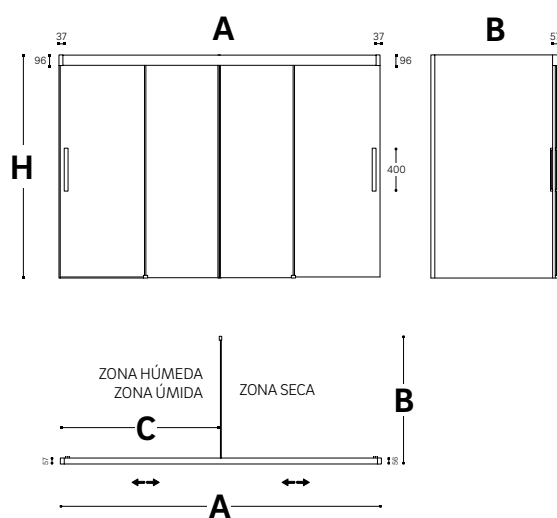
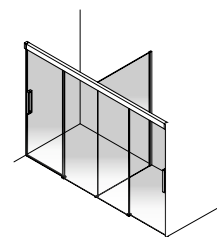

PARA PLATOS DE DUCHA ENRASADOS O INDICAR EN CROQUIS  
 PARA BASES DE DUCHA NIVELADAS OU INDICAR NO CROQUÍ

Dimensiones en mm.  
 Dimensões em mm.



VIDRIO TEMPLADO  
 VIDRO TEMPERADO  
**8 MM**



COMPENSACIÓN A CADA LADO  
 COMPENSAÇÃO A CADA LADO  
**15 MM**



EN ZONA HÚMEDA  
 EM ZONA ÚMIDA



TIRADOR  
 PUXADOR  
**400-700 MM**



MONTAJE  
 MONTAJEM  
**200 € \***

\* Precio recomendado  
 Código montaje **CSM26**  
 Para desplazamientos  
 consultar pág. **373**

\* Preço recomendado  
 Código montagem **CSM26**  
 Para deslocações  
 consultar pág. **373**

Se adjunta hoja de  
 instalación personalizada  
 Folha de instalação  
 personalizada anexada



MEDIDAS Y ALTURAS ESPECIALES  
 MEDIDAS E ALTURAS ESPECIAIS  
**HASTA / ATÉ 2500 MM**  
 (VER PÁG. / CONSULTA A PÁG. **372**)



SOFT-CLOSE  
 SOFTCLOSE



DEBE INDICARNOS LA MEDIDA **C**. EL FRONTAL  
 SIEMPRE SERA UNA REFERENCIA ESPECIAL.  
 DEBE INDICARNOS LA MEDIDA **C**. EL FRONTAL  
 SIEMPRE SERA UNA REFERENCIA ESPECIAL.

### ACABADOS METÁLICOS ACABAMENTOS METÁLICOS



BRILLO  
 BRILHO



NEGRO MATE  
 PRETO MATE



INOX MATE  
 INOX MATE

### TIRADOR PUXADOR



400 MM  
 500 MM  
 600 MM  
 700 MM

## SOLUCIÓN ST3 | FRONTAL

A mm		PERFIL BRILLO PERFIL BRILHO							
		2000-2200 mm		2201-2400 mm		2401-2600 mm		2601-2800 mm	
MEDIDAS ALTURA (H) mm		2100-2200	2201-2500	2100-2200	2201-2500	2100-2200	2201-2500	2100-2200	2201-2500
VIDRIO VIDRO	Transparente	1.942 €	2.139 €	2.038 €	2.244 €	2.132 €	2.346 €	2.228 €	2.452 €
	Affumicato, Bronce, Mate, Transp. decorado	2.335 €	2.570 €	2.447 €	2.693 €	2.559 €	2.818 €	2.677 €	3.008 €
	Affumicato decorado, Bronce decorado Nuevos / Novos decorados *	2.626 €	2.890 €	2.756 €	3.036 €	2.879 €	3.171 €	2.946 €	3.310 €

A mm		INOX MATE / NEGRO MATE INOX MATE / PRETO MATE							
		2000-2200 mm		2201-2400 mm		2401-2600 mm		2601-2800 mm	
MEDIDAS ALTURA (H) mm		2100-2200	2201-2500	2100-2200	2201-2500	2100-2200	2201-2500	2100-2200	2201-2500
VIDRIO VIDRO	Transparente	2.273 €	2.503 €	2.385 €	2.626 €	2.497 €	2.749 €	2.610 €	2.874 €
	Affumicato, Bronce, Mate, Transp. decorado	2.727 €	3.002 €	2.862 €	3.149 €	2.997 €	3.299 €	3.131 €	3.446 €
	Affumicato decorado, Bronce decorado Nuevos / Novos decorados *	3.069 €	3.379 €	3.221 €	3.547 €	3.373 €	3.715 €	3.524 €	3.878 €

Estos precios incluyen un tirador de 400mm en el mismo acabado que el perfil de la mampara.

Estes valores incluem um puxador de 400mm do mesmo acabamento do perfil da divisória.

### TIRADOR PARA PUERTA DE ACCESO Y CORREDERA mm PUXADOR PARA PORTA DO ACCESO E PORTA DE CORRER mm

		400	500	600	700
		BRILLO BRILHO	Incluido / Incluso	+33 €	+66 €
INOX MATE / NEGRO MATE INOX MATE / PRETO MATE	Incluido / Incluso	+33 €	+66 €	+99 €	

## SOLUCIÓN SL3 | FIJO ENT

B mm		PERFIL BRILLO PERFIL BRILHO					
		600-800 mm		801-1000 mm		1001-1200 mm	
MEDIDAS ALTURA (H) mm		2100-2200	2201-2500	2100-2200	2201-2500	2100-2200	2201-2500
VIDRIO VIDRO	Transparente	461 €	512 €	556 €	612 €	652 €	719 €
	Affumicato, Bronce, Mate, Transp. decorado	556 €	612 €	668 €	736 €	786 €	865 €
	Affumicato decorado, Bronce decorado Nuevos / Novos decorados *	624 €	691 €	753 €	831 €	882 €	972 €

B mm		INOX MATE / NEGRO MATE INOX MATE / PRETO MATE					
		600-800 mm		801-1000 mm		1001-1200 mm	
MEDIDAS ALTURA (H) mm		2100-2200	2201-2500	2100-2200	2201-2500	2100-2200	2201-2500
VIDRIO VIDRO	Transparente	539 €	596 €	652 €	719 €	764 €	842 €
	Affumicato, Bronce, Mate, Transp. decorado	652 €	719 €	786 €	865 €	921 €	1.017 €
	Affumicato decorado, Bronce decorado Nuevos / Novos decorados *	730 €	803 €	882 €	972 €	1.033 €	1.140 €

\* Para serigrafías digitales confirmar precio con ATC. / Para serigrafías digitais confirmar preço com ATC.

### VIDRIO Y DECORADO VIDRO E DECORADO



### NUEVOS DECORADOS NOVOS DECORADOS



## SOLUCIÓN ST3 | LATERAL (OPCIONAL)

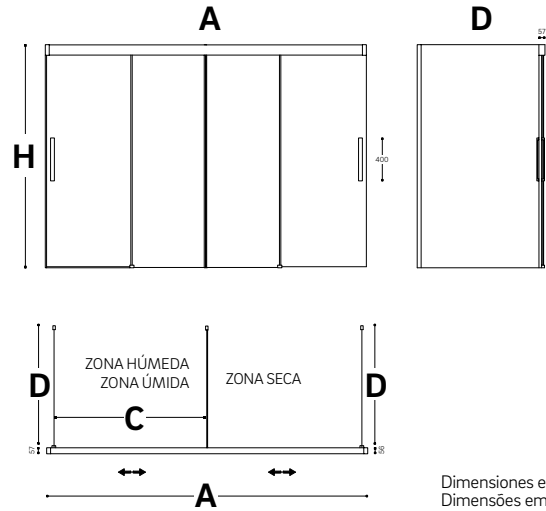

Dimensiones en mm.  
Dimensões em mm.

## SLC | LATERAL (OPCIONAL)

D mm		PERFIL BRILLO PERFIL BRILHO					
		600-800 mm		801-1000 mm		1001-1200 mm	
MEDIDAS ALTURA (H) mm		2100-2200	2201-2500	2100-2200	2201-2500	2100-2200	2201-2500
VIDRIO VIDRO	Transparente	388 €	427 €	450 €	489 €	500 €	550 €
	Affumicato, Bronce, Mate, Transp. decorado	467 €	505 €	505 €	556 €	601 €	663 €
	Affumicato decorado, Bronce decorado	528 €	585 €	574 €	635 €	680 €	753 €
	Nuevos / Novos decorados *						

D mm		INOX MATE / NEGRO MATE INOX MATE / PRETO MATE					
		600-800 mm		801-1000 mm		1001-1200 mm	
MEDIDAS ALTURA (H) mm		2100-2200	2201-2500	2100-2200	2201-2500	2100-2200	2201-2500
VIDRIO VIDRO	Transparente	456 €	505 €	523 €	579 €	590 €	652 €
	Affumicato, Bronce, Mate, Transp. decorado	550 €	607 €	630 €	697 €	708 €	780 €
	Affumicato decorado, Bronce decorado	618 €	680 €	708 €	780 €	798 €	882 €
	Nuevos / Novos decorados *						

### TOALLERO OPCIONAL PARA FIJO T O LATERAL mm \*\* TOALHEIRO OPCIONAL PARA FIJO T O LATERAL mm \*\*

	400	500	600	700
BRILLO BRILHO	+83 €	+94 €	+105 €	+116 €
INOX MATE / NEGRO MATE INOX MATE / PRETO MATE	+83 €	+94 €	+105 €	+116 €
MEDIDAS FRONTAL mm	600-1200	700-1200	801-1200	1001-1200

\*\* Ver página 371 para más información de cómo solicitar el toallero opcional.

\*\* Consulta a página 371 para mais informações sobre como solicitar o toalheiro opcional.

### ACABADOS METÁLICOS ACABAMENTOS METÁLICOS



BRILLO  
BRILHO



NEGRO MATE  
PRETO MATE



INOX MATE  
INOX MATE

### TIRADOR PUXADOR



400 MM  
500 MM  
600 MM  
700 MM

\* Para serigrafías digitales confirmar precio con ATC.  
Para serigrafias digitais confirmar preço com ATC.





**showertime**



# Stock

## Stock

**SELECCIÓN STOCK**

Entrega en 3 días

**SELEÇÃO STOCK**

Entrega entre 3 dias

Stock

Info

# Walk-in fijo



TECHNIC KH1

338 | 

TECHNIC KH1

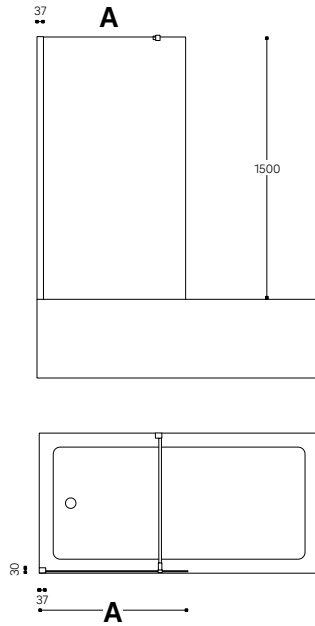

Dimensiones en mm.  
Dimensões em mm.



CÓDIGO DE MODELO	MEDIDA EN mm MEDIDA EM mm	RANGO DE INSTALACIÓN EN mm RANGO DE INSTALAÇÃO EM mm	PERFIL PLATA BRILLO PERFIL PRATA BRILHO	
				Vidrio / Vidro Transparente
<b>WJKH134A5DC012N0N</b>	842	835-850	235 €	--
<b>WJKH134A5DC012NMN</b>	842	835-850	--	280 €
CÓDIGO DE MODELO	MEDIDA EN mm MEDIDA EM mm	RANGO DE INSTALACIÓN EN mm RANGO DE INSTALAÇÃO EM mm	PERFIL INOX MATE/NEGRO MATE PERFIL INOX MATE/PRETO MATE	<b>NEW</b>
			Vidrio / Vidro Transparente	Vidrio / Vidro Transparente + Drop Free
<b>WJKH134A5DC016N0N</b>	842	835-850	294 €	--
<b>WJKH134A5DC016NMN</b>	842	835-850	--	350 €



VIDRIO TEMPLADO  
VIDRO TEMPERADO  
6 MM



COMPENSACIÓN A CADA LADO  
COMPENSAÇÃO EM CADA LADO  
15 MM



ALTURA MODELO  
ALTURA MODELO  
1500 MM



REVERSIBLE  
REVERSÍVEL



MONTAJE  
MONTAJEM  
85 € \*

\* Precio recomendado  
Código montaje **CSM03**  
Para desplazamientos  
consultar pág. **373**

\* Preço recomendado  
Código montagem **CSM03**  
Para deslocações  
consultar pág. **373**



TRATAMIENTO OPCIONAL (M)  
TRATAMENTO OPCIONAL (M)

### ACABADOS METÁLICOS ACABAMENTOS METÁLICOS



PLATA BRILLO  
PRATA BRILHO



NEGRO MATE  
PRETO MATE

### VIDRIO Y DECORADO VIDRO E DECORADO

TRANSP.



SIN DECORADO

TRANSP. + Drop Free



# Walk-in Batiente



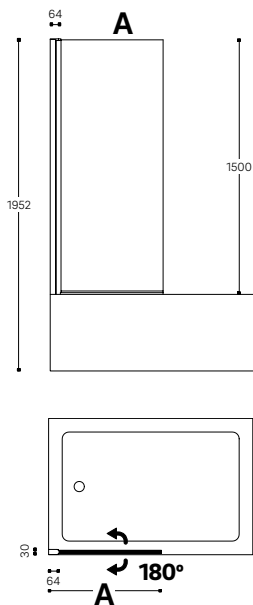

Dimensiones en mm.  
Dimensões em mm.



CÓDIGO DE MODELO	MEDIDA EN mm MEDIDA EM mm	RANGO DE INSTALACIÓN EN mm RANGO DE INSTALAÇÃO EM mm	PERFIL PLATA BRILLO PERFIL PRATA BRILHO	
			Vidrio / Vidro Transparente	Vidrio / Vidro Transparente + Drop Free
WJKHB3185DC012N0N	792	785-800	223 €	--
WJKHB3185DC012NMN	792	785-800	--	268 €
WJKHB37C5DC012N0N	892	885-900	242 €	--
WJKHB37C5DC012NMN	892	885-900	--	287 €



VIDRIO TEMPLADO  
VIDRO TEMPERADO  
6 MM



COMPENSAIÓN A CADA LADO  
COMPENSAÇÃO EM CADA LADO  
15 MM



ALTURA MODELO  
ALTURA MODELO  
1500 MM



REVERSIBLE  
REVERSÍVEL



MONTAJE  
MONTAJEM  
85 € \*



TRATAMIENTO OPCIONAL (M)  
TRATAMENTO OPCIONAL (M)



UP&DOWN  
UP&DOWN

\* Precio recomendado  
Código montaje **CSM03**  
Para desplazamientos  
consultar pág. **373**

\* Preço recomendado  
Código montagem **CSM03**  
Para deslocações  
consultar pág. **373**

## ACABADOS METÁLICOS ACABAMENTOS METÁLICOS



PLATA BRILLO  
PRATA BRILHO



NEGRO MATE  
PRETO MATE

## VIDRIO Y DECORADO VIDRO E DECORADO

TRANSP.



SIN DECORADO

TRANSP. + Drop Free



# Walk-in Batiente



TECHNIC KHS

342 | 



KHS | WALK-IN BAÑERA: 1 PUERTA BATIENTE Y 1 FIJO  
WALK-IN BANHEIRA: 1 PORTA DE ABRIR E 1 FIXO

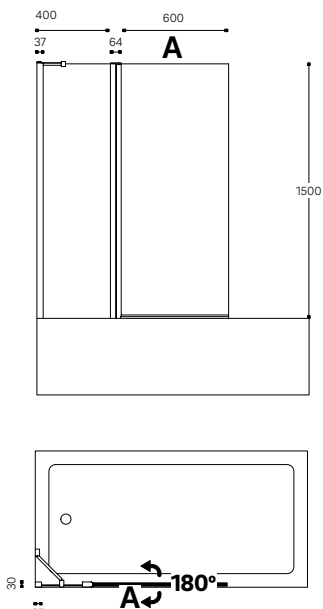

Dimensiones en mm.  
Dimensões em mm.



CÓDIGO DE MODELO	MEDIDA EN mm	RANGO DE INSTALACIÓN EN mm	PERFIL PLATA BRILLO	PERFIL PRATA BRILHO
	MEDIDA EM mm	RANGO DE INSTALAÇÃO EM mm	Vidrio / Vidro Transparente	Vidrio / Vidro Transparente + Drop Free
WJKHS3E05DC012N0N	992	985-1000	365 €	--
WJKHS3E05DC012NMN	992	985-1000	--	420 €



VIDRIO TEMPLADO  
VIDRO TEMPERADO  
6 MM



COMPENSACIÓN A CADA LADO  
COMPENSAÇÃO EM CADA LADO  
15 MM



ALTURA MODELO  
ALTURA MODELO  
1500 MM



REVERSIBLE  
REVERSÍVEL



MONTAJE  
MONTAJEM  
90 € \*

\* Precio recomendado  
Código montaje **CSM04**  
Para desplazamientos  
consultar pág. **373**

\* Preço recomendado  
Código montagem **CSM04**  
Para deslocações  
consultar pág. **373**



TRATAMIENTO OPCIONAL (M)  
TRATAMENTO OPCIONAL (M)



UP&DOWN  
UP&DOWN

## ACABADOS METÁLICOS ACABAMENTOS METÁLICOS



PLATA BRILLO  
PRATA BRILHO

## VIDRIO Y DECORADO VIDRO E DECORADO

TRANSP.



SIN DECORADO

TRANSP. + Drop Free



# Walk-in fijo



TECHNIC.KW6

344 

# supra2 · technic

KW8 · KW6 | WALK IN DE DUCHA: 1 FIJO  
WALK IN DE DUCHE: 1 FIJO

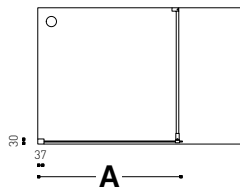
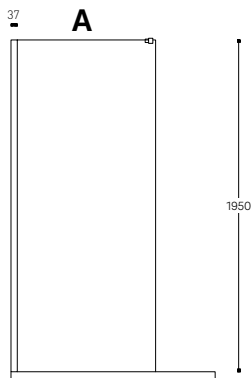

Dimensiones en mm.  
Dimensões em mm.



supra2 KW8 8 mm	MEDIDA EN mm MEDIDA EM mm	RANGO DE INSTALACIÓN EN mm RANGO DE INSTALAÇÃO EM mm	PERFIL PLATA BRILLO PERFIL PRATA BRILHO
CÓDIGO DE MODELO			Vidrio / Vidro Transparente
WJKW84AB79E012NON	1195	1190-1200	325 €
WJKW84AB79E012NMN	1195	1190-1200	--
			Vidrio / Vidro Transparente + Drop Free
			370 €
technic KW6 6 mm	MEDIDA EN mm MEDIDA EM mm	RANGO DE INSTALACIÓN EN mm RANGO DE INSTALAÇÃO EM mm	PERFIL PLATA BRILLO PERFIL PRATA BRILHO
CÓDIGO DE MODELO			Vidrio / Vidro Transparente
WJKW63E079E012NON	992	985-1000	269 €
WJKW63E079E012NMN	992	985-1000	--
WJKW64A879E012NON	1192	1185-1200	299 €
WJKW64A879E012NMN	1192	1185-1200	--
			Vidrio / Vidro Transparente + Drop Free
			314 €
technic KW6 6 mm	MEDIDA EN mm MEDIDA EM mm	RANGO DE INSTALACIÓN EN mm RANGO DE INSTALAÇÃO EM mm	PERFIL INOX MATE/NEGRO MATE PERFIL INOX MATE/PRETO MATE <b>NEW</b>
CÓDIGO DE MODELO			Vidrio / Vidro Transparente
WJKW63E079E016NON	992	985-1000	336 €
WJKW63E079E016NMN	992	985-1000	--
WJKW64A879E016NON	1192	1185-1200	374 €
WJKW64A879E016NMN	1192	1185-1200	--
			Vidrio / Vidro Transparente + Drop Free
			419 €



VIDRIO SUPRA2  
VIDRO SUPRA2  
8MM



VIDRIO TECHNIC  
VIDRO TECHNIC  
6MM



COMPENSACIÓN SUPRA2  
COMPENSAÇÃO SUPRA2  
10 MM



COMPENSACIÓN TECHNIC  
COMPENSAÇÃO TECHNIC  
15 MM



MONTAJE hasta 1000mm  
MONTAJEM à 1000mm  
100 € \*  
Medidas mayores a 1000mm  
Medidas maiores a 1000mm  
100 €



ALTURA MODELO  
ALTURA MODELO  
1950 MM



TRATAMIENTO OPCIONAL (M)  
TRATAMENTO OPCIONAL (M)



REVERSIBLE  
REVERSÍVEL

\* Precio recomendado  
Código montaje **CSM06**  
Para desplazamientos  
consultar pág. 237  
\* Preço recomendado  
Código montagem **CSM06**  
Para deslocações  
consultar pág. 237

## ACABADOS METÁLICOS ACABAMENTOS METÁLICOS



PLATA BRILLO  
PRATA BRILHO

## VIDRIO Y DECORADO VIDRO E DECORADO

TRANSP.



SIN DECORADO

TRANSP. + Drop Free



# Walk-in fijo



B-SMART BW1

346 

EL PRECIO INCLUYE:  
EL PRECIO INCLUYE:

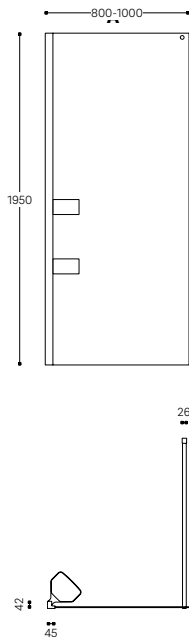

Dimensiones en mm.  
Dimensões em mm.



CÓDIGO DE MODELO	MEDIDA EN mm	RANGO DE INSTALACIÓN EN mm	PERFIL PLATA BRILLO
	MEDIDA EM mm	RANGO DE INSTALAÇÃO EM mm	PERFIL PRATA BRILHO
WJBW132079E012NON	800	788-813	Vidrio / Vidro Transparente 215 €
WJBW138479E012NON	900	888-913	226 €
WJBW13E879E012NON	1000	988-1013	238 €



VIDRIO TEMPLADO  
VIDRO TEMPERADO  
5 MM



COMPENSACIÓN  
COMPENSAÇÃO  
20 MM



ALTURA ESTÁNDAR  
ALTURA NORMA  
1950 MM



REVERSIBLE  
REVERSÍVEL



MONTAJE  
MONTAJEM  
100 € \*



SISTEMA DUAL\*  
SISTEMA DUAL\*



FÁCIL INSTALACIÓN  
FÁCIL INSTALAÇÃO  
20 MIN.

\* Precio recomendado  
Código montaje **CSM06**  
Para desplazamientos  
consultar pág. **373**

\* Preço recomendado  
Código montagem **CSM086**  
Para deslocações  
consultar pág. **373**

### CARACTERÍSTICAS GENERALES CARACTERÍSTICAS GENERALES



TUTORIALES  
EN VIDEO  
TUTORIAIS  
EM VIDEO

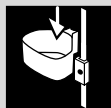

PERFIL DISEÑADO PARA  
COLGAR LOS ACCESORIOS  
INCLUIDOS EN EL PRECIO  
PERFIL PROJETADO  
PARA PENDURAR OS  
ACCESÓRIOS INCLUIDOS  
NO PREÇO



PRODUCTO  
EN STOCK  
PRODUTO  
EM STOCK



**DUAL**  
SYSTEM

SISTEMA DE  
INSTALACIÓN DUAL  
SISTEMA DE  
INSTALAÇÃO DUAL

## Frontal corredera



B-SMART BC2

348 

EL PRECIO INCLUYE:  
EL PRECIO INCLUYE:

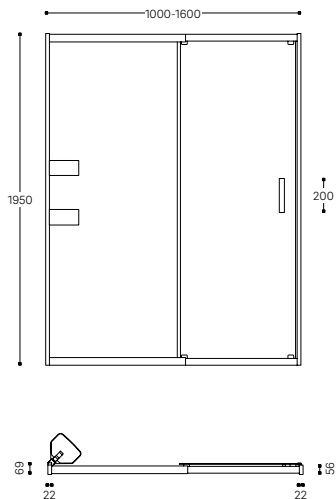

Dimensiones en mm.  
Dimensões em mm.



CÓDIGO DE MODELO	MEDIDA EN mm	RANGO DE INSTALACIÓN EN mm	PERFIL PLATA BRILLO
	MEDIDA EM mm	RANGO DE INSTALAÇÃO EM mm	PERFIL PRATA BRILHO
<b>WJBC23E879E012NON</b>	1000	960-1059	Vidrio / Vidro Transparente 352 €
<b>WJBC244C79E012NON</b>	1100	1060-1159	365 €
<b>WJBC248079E012NON</b>	1200	1160-1259	377 €
<b>WJBC251479E012NON</b>	1300	1260-1359	390 €
<b>WJBC257879E012NON</b>	1400	1360-1459	402 €
<b>WJBC25DC79E012NON</b>	1500	1460-1559	415 €
<b>WJBC264079E012NON</b>	1600	1560-1659	427 €

**5**  
VIDRIO TEMPLADO  
VIDRO TEMPERADO  
5 MM

**100**  
GUÍA TELESCÓPICA CON  
EXTENSIÓN DE HASTA  
GUÍA TELESCÓPICA CON  
EXTENSÃO GUIA  
100 MM

**1950**  
ALTURA ESTÁNDAR  
ALTURA NORMA  
1950 MM

**R**  
REVERSIBLE  
REVERSÍVEL

**MONTAJE**  
MONTAJEM  
95 € \*

**SISTEMA DUAL**  
SISTEMA DUAL

**FÁCIL INSTALACIÓN**  
FÁCIL INSTALAÇÃO  
30 MIN.

**SE SIRVE PREMONTADA**  
SERVIDO PREMONTADO

\* Precio recomendado  
Código montaje **CSM05**  
Para desplazamientos  
consultar pág. **373**  
\* Preço recomendado  
Código montagem **CSM05**  
Para deslocações  
consultar pág. **373**

### CARACTERÍSTICAS GENERALES CARACTERÍSTICAS GENERALES



TUTORIALES  
EN VIDEO  
TUTORIAIS  
EM VIDEO

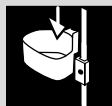

PERFIL DISEÑADO PARA  
COLGAR LOS ACCESORIOS  
INCLUIDOS EN EL PRECIO  
PERFIL PROJETADO  
PARA PENDURAR OS  
ACESSÓRIOS INCLUIDOS  
NO PREÇO



PRODUCTO  
EN STOCK  
PRODUTO  
EM STOCK



**DUAL**  
SYSTEM

SISTEMA DE  
INSTALACIÓN DUAL  
SISTEMA DE  
INSTALAÇÃO DUAL

# Frontal corredera



B-SMART BC2 + BLC

350 | D



## BC2 + BLC

MAMPARA DE DUCHA: 1 PUERTA CORREDERA Y 1 FIJO MÁS LATERAL  
DIVISÓRIA DE DUCHE: 1 PORTA DE CORRER E 1 FIXO MAIS LATERAL

EL PRECIO INCLUYE:  
EL PRECIO INCLUYE:

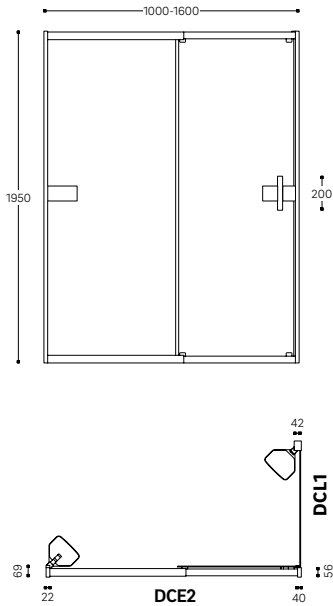

Dimensiones en mm.  
Dimensões em mm.



BC2 FRONTAL	MEDIDA EN mm MEDIDA EM mm	RANGO DE INSTALACIÓN EN mm RANGO DE INSTALAÇÃO EM mm	PERFIL PLATA BRILLO PERFIL PRATA BRILHO
CÓDIGO DE MODELO			Vidrio / Vidro Transparente
<b>WJBC23E879E012NON</b>	1000	960-1059	352 €
<b>WJBC244C79E012NON</b>	1100	1060-1159	365 €
<b>WJBC24B079E012NON</b>	1200	1160-1259	377 €
<b>WJBC251479E012NON</b>	1300	1260-1359	390 €
<b>WJBC257879E012NON</b>	1400	1360-1459	402 €
<b>WJBC25DC79E012NON</b>	1500	1460-1559	415 €
<b>WJBC264079E012NON</b>	1600	1560-1659	427 €

BLC LATERAL	MEDIDA EN mm MEDIDA EM mm	RANGO DE INSTALACIÓN EN mm RANGO DE INSTALAÇÃO EM mm	PERFIL PLATA BRILLO PERFIL PRATA BRILHO
CÓDIGO DE MODELO			Vidrio / Vidro Transparente
<b>WJBLC2BC79E012NON</b>	700	960-1059	197 €
<b>WJBLC2EE79E012NON</b>	750	1060-1159	202 €
<b>WJBLC32079E012NON</b>	800	1160-1259	208 €



VIDRIO TEMPLADO  
VIDRO TEMPERADO  
5 MM



COMPENSACIÓN DEL LATERAL  
COMPENSAÇÃO DO LATERAL  
50 MM



ALTURA ESTÁNDAR  
ALTURA NORMA  
1950 MM



GUÍA TELESCÓPICA CON  
EXTENSIÓN DE HASTA  
GUÍA TELESCÓPICA CON  
EXTENSAO GUIA  
100 MM



MONTAJE  
MONTAJEM  
120 € \*



SISTEMA DUAL\*  
SISTEMA DUAL\*



FÁCIL INSTALACIÓN  
FÁCIL INSTALAÇÃO  
45 MIN.



SE SIRVE PREMONTADA  
SERVIDO PREMONTADO



REVERSIBLE  
REVERSÍVEL

\* Precio recomendado  
Código montaje **CSM10**  
Para desplazamientos  
consultar pág. **373**

\* Preço recomendado  
Código montagem **CSM10**  
Para deslocações  
consultar pág. **373**

### CARACTERÍSTICAS GENERALES CARACTERÍSTICAS GENERALES



TUTORIALES  
EN VIDEO  
TUTORIAIS  
EM VIDEO

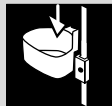

PERFIL DISEÑADO PARA  
COLGAR LOS ACCESORIOS  
INCLUIDOS EN EL PRECIO  
PERFIL PROJETADO  
PARA PENDURAR OS  
ACESSÓRIOS INCLUIDOS  
NO PREÇO



PRODUCTO  
EN STOCK  
PRODUTO  
EM STOCK



**DUAL  
SYSTEM**

SISTEMA DE  
INSTALACIÓN DUAL  
SISTEMA DE  
INSTALAÇÃO DUAL

# Angular corredera



B-SMART BC5

352 

EL PRECIO INCLUYE:  
EL PRECIO INCLUYE:

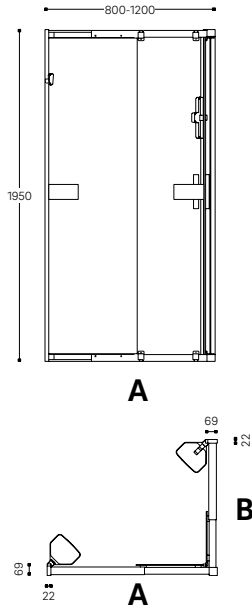

Dimensiones en mm.  
Dimensões em mm.



<b>A</b>	MEDIDA EN mm MEDIDA EM mm	RANGO DE INSTALACIÓN EN mm RANGO DE INSTALAÇÃO EM mm	PERFIL PLATA BRILLO PERFIL PRATA BRILHO
CÓDIGO DE MODELO			Vidrio / Vidro Transparente
<b>WJBC52BC79E012NON</b>	700	680-695	260 €
<b>WJBC532079E012NON</b>	800	780-795	270 €
<b>WJBC538479E012NON</b>	900	880-895	281 €
<b>WJBC53E879E012NON</b>	1000	980-995	291 €
<b>WJBC54B079E012NON</b>	1200	1180-1195	310 €

<b>B</b>	MEDIDA EN mm MEDIDA EM mm	RANGO DE INSTALACIÓN EN mm RANGO DE INSTALAÇÃO EM mm	PERFIL PLATA BRILLO PERFIL PRATA BRILHO
CÓDIGO DE MODELO			Vidrio / Vidro Transparente
<b>WJBC52BC79E012NON</b>	700	680-695	260 €
<b>WJBC532079E012NON</b>	800	780-795	270 €
<b>WJBC538479E012NON</b>	900	880-895	281 €
<b>WJBC53E879E012NON</b>	1000	980-995	291 €
<b>WJBC54B079E012NON</b>	1200	1180-1195	310 €

Para precio total, sumar ambos lados A y B.  
Para o preço total, some os dois lados A e B.

**5**  
VIDRIO TEMPLADO  
VIDRO TEMPERADO  
5 MM

**100**  
GUÍA TELESCÓPICA CON EXTENSIÓN DE HASTA  
GUÍA TELESCÓPICA CON EXTENSÃO GUIA  
100 MM

**1950**  
ALTURA ESTÁNDAR  
ALTURA NORMA  
1950 MM

**R**  
REVERSIBLE  
REVERSÍVEL

**125 € \***  
MONTAJE  
MONTAJEM

**SISTEMA DUAL**  
SISTEMA DUAL

**FÁCIL INSTALACIÓN**  
FÁCIL INSTALAÇÃO  
45 MIN.

**SE SIRVE PREMONTADA**  
SERVIDO PREMONTADO

\* Precio recomendado  
Código montaje **CSM11**  
Para desplazamientos  
consultar pág. **373**  
\* Preço recomendado  
Código montagem **CSM11**  
Para deslocações  
consultar pág. **373**

**CARACTERÍSTICAS GENERALES**  
CARACTERÍSTICAS GENERALES



TUTORIALES EN VIDEO  
TUTORIAIS EM VIDEO

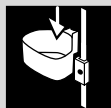

PERFIL DISEÑADO PARA COLGAR LOS ACCESORIOS INCLUIDOS EN EL PRECIO  
PERFIL PROJETADO PARA PENDURAR OS ACCESÓRIOS INCLUIDOS NO PREÇO



PRODUCTO EN STOCK  
PRODUTO EM STOCK



**DUAL SYSTEM**

SISTEMA DE INSTALACIÓN DUAL  
SISTEMA DE INSTALAÇÃO DUAL



# Accesorios b-smart

## Acessórios b-smart



**WJB070A0021005**

PERCHA  
CABIDE

6,50 €

3,6x3x6,5 CM / INCH 1.4x1.2x2.6



**WJB070A0050005**

CONTAINER  
CONTÊINER

17,00 €

18,4x18,1x9 CM / INCH 7.2x7.1x3.5



**WJB070A0061005**

LIMPIACRISTALES  
LIMPADOR DE VIDROS

11,50 €

7,1x2,3x24 CM / INCH 2.8x0.9x9.4

Stock

Info



# Platos de ducha

## Bases de ducha







Nuevos platos de ducha extraplanos COSMIC con un acabado texturado muy agradable al tacto.

As novas bases de duche extraplanas COSMIC com um acabamento texturizado muito agradável ao toque.





Material que ofrece el máximo confort, compuesto por resina de poliéster combinada con cargas minerales y superficie de gel coat.

Material que ofrece o máximo confort, composto por resina de poliéster combinada com cargas minerais e superfície de gel coat.



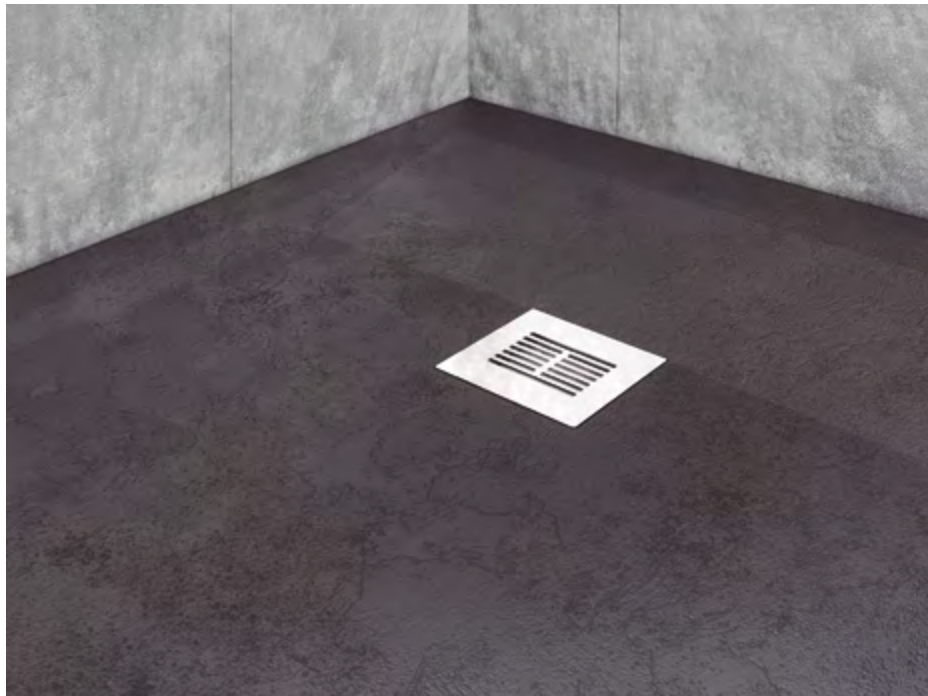

Platos antideslizantes, que garantizan la máxima seguridad.

Bases antideslizantes, que garantem a máxima segurança.

# pietra

PLATO DE DUCHA CON DESAGÜE  
BASE DE DUCHE COM RALO



BLANCO  
BRANCO

ANTRACITA  
ANTHRACITE

NEGRO  
PRETO

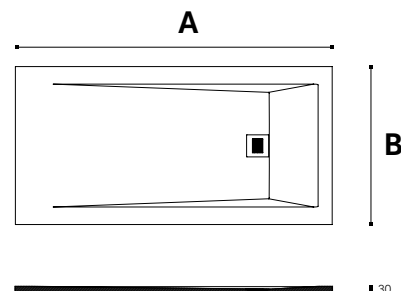

Dimensiones en mm.  
Dimensões em mm.



ANTIDESLIZANTE  
ANTIDESLIZANTE



VÁLVULA CON SIFÓN CENTRADA  
CON TAPA DE ACERO INOXIDABLE  
VÁLVULA COM SIFÃO CENTRADA  
COM TAMPA DE AÇO INOXIDÁVEL



BASE EXTRAPLANA  
BASE EXTRAPLANA  
30 MM



ÂNGULOS DE  
ÂNGULOS DE  
90°



RECORTABLE A MEDIDA  
CORTE CUSTOMIZÁVEL

PRECIO

PREÇO  
1 corte / corte 21 €  
2 cortes / cortes 31 €  
3 cortes / cortes 51 €

## ACABADO ACABAMENTO



BLANCO  
BRANCO



NEGRO  
PRETO



ANTRACITA  
ANTHRACITE

## PLATO DE DUCHA · BASE DE DUCHE

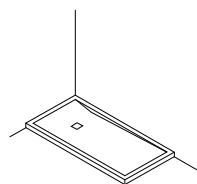

Estos precios incluyen válvula con sifón estándar (90 mm diámetro) con rejilla de acero inoxidable.  
Os preços incluem válvula com sifão padrão (90 mm de diâmetro) com grelha de aço inoxidável.

CÓDIGO DE MODELO	A x B mm	
		PRECIO
WJC090S0057_--	1000x700	256 €
WJC090S0058_--	1000x800	282 €
WJC090S0059_--	1000x900	318 €
WJC090S0063_--	1200x700	308 €
WJC090S0064_--	1200x800	349 €
WJC090S0065_--	1200x900	369 €
WJC090S0069_--	1400x700	338 €
WJC090S0070_--	1400x800	390 €
WJC090S0071_--	1400x900	415 €
WJC090S0075_--	1600x700	364 €
WJC090S0076_--	1600x800	451 €
WJC090S0077_--	1600x900	482 €
WJC090S0080_--	1800x800	477 €
WJC090S0081_--	1800x900	538 €
WJC090S0084_--	2000x800	564 €
WJC090S0085_--	2000x900	605 €

ACABADO ACABAMENTO	CÓDIGO (- - -)
BLANCO BRANCO	500
NEGRO PRETO	536
ANTRACITA ANTHRACITE	535

VÁLVULA PLATOS DE DUCHA PIETRA VÁLVULA BASE DE DUCHE PIETRA	PRECIO
WJC341R9488000	49 €

**NÚMERO DE CORTES** Plazo para el corte: 1 semana. La referencia se deberá solicitar a Customer Service.

**NÚMERO DE CORTES** Prazo de corte: 1 semana. A referência deve ser solicitada ao Customer Service.

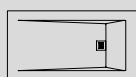

**0**  
SIN CORTE  
SEM CORTE

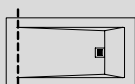

**1**  
CORTE (1 ANCHO)  
CORTE (1 ARGURA)

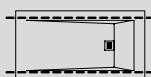

**2**  
CORTES (2 LARGO)  
CORTES (2 COMPRIMENTO)

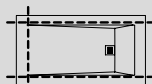

**3**  
CORTES (2 LARGO + 1 ANCHO)  
CORTES (2 COMPRIMENTO + 1 ARGURA)





# **Info y Anexos Técnicos**

**Info e Anexos Técnicos**

# Perfiles suplementarios

## Perfis suplementares

### SUITE

#### PERFIL RECTANGULAR 40X10 2500mm

##### PERFIL RECTANGULAR 40X10 2500mm

RT675922500.89	PLATA BRILLO / PRATA BRILHO	75 €
RT675922500.60	NEGRO MATE / PRETO MATE	95 €

#### PERFIL CUADRADO 40X40 2500mm

##### PERFIL CUADRADO 40X40 2500mm

RT535582500.89	PLATA BRILLO / PRATA BRILHO	85 €
RT535582500.60	NEGRO MATE / PRETO MATE	115 €
RT535582500.59	INOX MATE / INOX MATE	115 €

#### PERFIL RECTANGULAR 40X20 2500mm

##### PERFIL RECTANGULAR 40X20 2500mm

RT535152500.89	PLATA BRILLO / PRATA BRILHO	65 €
RT535152500.60	NEGRO MATE / PRETO MATE	85 €
RT535152500.59	INOX MATE / INOX MATE	85 €

#### PERFIL ANGULAR 35X15 2500mm

##### PERFIL ANGULAR 35X15 2500mm

RT552962500.89	PLATA BRILLO / PRATA BRILHO	50 €
RT552962500.60	NEGRO MATE / PRETO MATE	65 €
RT552962500.59	INOX MATE / INOX MATE	65 €

#### PERFIL ANGULAR 40X20 2500mm

##### PERFIL ANGULAR 40X20 2500mm

RT552972500.89	PLATA BRILLO / PRATA BRILHO	55 €
RT552972500.60	NEGRO MATE / PRETO MATE	70 €
RT552972500.59	INOX MATE / INOX MATE	70 €

#### PERFIL RECTANGULAR 60X40 2500mm

##### PERFIL RECTANGULAR 60X40 2500mm

RT535602500.89	PLATA BRILLO / PRATA BRILHO	95 €
RT535602500.60	NEGRO MATE / PRETO MATE	125 €
RT535602500.59	INOX MATE / INOX MATE	125 €

### TECHNIC / PLUS

#### PERFIL RECTANGULAR 40X10 1950mm

##### PERFIL RECTANGULAR 40X10 1950mm

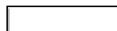
T991611001	BLANCO / BRANCO	37 €	
T991611002	PLATA BRILLO / PRATA BRILHO	42 €	
T991611003	PLATA MATE / PRATA MATE	37 €	

#### PERFIL CUADRADO 40X40 1950mm

##### PERFIL CUADRADO 40X40 1950mm

T991611301	BLANCO / BRANCO	50 €	
T991611302	PLATA BRILLO / PRATA BRILHO	66 €	
T991611303	PLATA MATE / PRATA MATE	54 €	

#### PERFIL RECTANGULAR 40X20 1950mm

##### PERFIL RECTANGULAR 40X20 1950mm

T991611501	BLANCO / BRANCO	37 €	
T991611502	PLATA BRILLO / PRATA BRILHO	52 €	
T991611503	PLATA MATE / PRATA MATE	48 €	

#### PERFIL ANGULAR 35X15 1950mm

##### PERFIL ANGULAR 35X15 1950mm

T991613301	BLANCO / BRANCO	36 €	
T991613302	PLATA BRILLO / PRATA BRILHO	42 €	

#### PERFIL ANGULAR 40X20 1950mm

##### PERFIL ANGULAR 40X20 1950mm

T991614201	BLANCO / BRANCO	36 €	
T991614202	PLATA BRILLO / PRATA BRILHO	51 €	
T991614203	PLATA MATE / PRATA MATE	42 €	

#### PERFIL RECTANGULAR 60X40 1950mm

##### PERFIL RECTANGULAR 60X40 1950mm

T991610501	BLANCO / BRANCO	59 €	
T991610502	PLATA BRILLO / PRATA BRILHO	82 €	

#### PERFIL RECTANGULAR 40X5 1950mm

##### PERFIL RECTANGULAR 40X5 1950mm

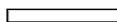
T991612402	PLATA BRILLO / PRATA BRILHO	30 €	
------------	-----------------------------	------	---

#### PERFIL ANGULAR 30X30 1950mm

##### PERFIL ANGULAR 30X30 1950mm

T991613002	PLATA BRILLO / PRATA BRILHO	32 €	
------------	-----------------------------	------	---

#### PERFIL ANGULAR 60X40 1950mm

##### PERFIL ANGULAR 60X40 1950mm

T991613602	PLATA BRILLO / PRATA BRILHO	44 €	
------------	-----------------------------	------	---

#### TAPETA UNIVERSAL PARA PERFILES\*

##### TAPETA UNIVERSAL PARA PERFILES\*

RT5100316.9	GRIS	6 €	
-------------	------	-----	---

\*Todos los perfiles suplementarios incluyen una tapeta universal Ref. RT5100316.9

\*Toudos os perfis suplementares incluem uma tapeta universal Ref. RT5100316.9

# Recambios

## Peças de reposição

### SUITE CORREDERAS · PORTAS DE CORRER

**AMORTIGUADORES**  
AMORTECEDORES  
RGT200208 **29 €**

**CONJUNTO PERFIL MAGNÉTICO SIDCE4/SIDCL4**  
CONJUNTO PERFIL MAGNÉTICO SIDCE4/SIDCL4  
RT3S06452500.32 **39 €**

**CONJUNTO PERFIL CRUCE 2500 MM.**  
CONJUNTO PERFIL CRUZ 2500 MM.  
RT3S06462400.32 **41 €**

**BURLETE VERTICAL CIERRE 2500 MM.**  
PERFIL VERTICAL DE FECHO 2500 MM.  
RT3S06482500.32 **27 €**

**PERFIL MAGNÉTICO 2500 MM.**  
PERFIL MAGNÉTICO 2500 MM.  
RT520529S012500.9 **25 €**

**BURLETE MAGNÉTICO 90° 2500 MM.**  
PERFIL MAGNÉTICO 90° 2500 MM.  
RT520095S012500.32 **26 €**

**BURLETE VIERTEAGUAS 1200 MM.**  
PERFIL VERTE ÁGUAS 1200 MM.  
RT520538S011200.32 **21 €**

**KIT CIERRE MAGNÉTICO SIDCC2 2500 MM.**  
KIT FECHO MAGNÉTICO SIDCC2 2500 MM.  
RT9900014.32 **19 €**

**RUEDA (2 UNID)**  
RODA (2 UNID)  
RGT200212 **42 €**

**TOPE (2 UNID)**  
TRAVÃO (2 UNID)  
RGT200198 **16 €**

**U GUIA PUERTA**  
U GUIA PORTA  
RGT200199 MAMPARA / DIVISÓRIA **10 €**  
RGT200200 ACCESO / ACESSO **10 €**

**PERFIL INFERIOR BASE 1500**  
PERFIL INFERIOR BASE 1500  
RT73038004S1500.89 BRILLO / BRILHO **24 €**  
RT73038004S1500.59 INOX MATE / INOX MATE **24 €**  
RT73038004S1500.60 NEGRO MATE / PRETO MATE **24 €**

**TERMINALES PERFIL BASE FIJO**  
TERMINAIS PERFIL BASE FIXO  
RGT200202.1 CROMO / CROMO **11 €**  
RT200202.29 INOX MATE / INOX MATE **29 €**  
RT200202.30 NEGRO MATE / PRETO MATE **29 €**

**TERMINALES PERFIL BASE CIERRE**  
TERMINAIS PERFIL BASE DE FECHO  
RGT200203.1 CROMO / CROMO **12 €**  
RT200203.29 INOX MATE / INOX MATE **30 €**  
RT200203.30 NEGRO MATE / PRETO MATE **30 €**

**TERMINALES PERFIL BASE LATERAL**  
TERMINAIS PERFIL BASE LATERAL  
RGT200204.1 CROMO / CROMO **14 €**  
RT200204.29 INOX MATE / INOX MATE **32 €**  
RT200204.30 NEGRO MATE / PRETO MATE **32 €**

### SUITE BATIENTES · PORTAS DE ABRIR

**CONJUNTO BURLETES ESTANQUEIDAD ENTRE BISAGRAS**  
CONJUNTO PERFIS ESTANQUEIDADE ENTRE DOBRADIÇAS  
RT9900015.32 **55 €**

**BURLETE CIERRE MAGNÉTICO 180° 2.250MM.**  
PERFIL DE FECHO MAGNÉTICO 180° 2.250MM  
RT520095000 **37 €**

**CONJUNTO BURLETES MAGNÉTICOS CIERRE ANGULAR 45° 2.000 MM.**  
CONJUNTO PERFIS MAGNÉTICOS DE FECHO ANGULAR 45° 2.000 MM.  
RT9900016.32 **41 €**

**CONJUNTO BURLETES CIERRE MAGNÉTICO 180°**  
CONJUNTO PERFIS DE FECHO MAGNÉTICO 180°  
RT9900017.32 **57 €**

**CONJUNTO BURLETES MAGNÉTICOS CIERRE ANGULAR 180° 2.200 MM.**  
CONJUNTO PERFIS MAGNÉTICOS DE FECHO ANGULAR 180° 2.000 MM.  
RT9900018.32 **46 €**

**GOMA VIERTEAGUAS PUERTA**  
PERFIL VERTE ÁGUAS PORTA  
RT520097S010319.32 300 **26 €**  
RT520097S010419.32 400 **26 €**  
RT520097S010519.32 500 **26 €**  
RT520097S010619.32 600 **26 €**  
RT520097S010719.32 700 **26 €**  
RT520097S010819.32 800 **26 €**

**PERFIL INFERIOR BASE 1500 BRILLO**  
PERFIL INFERIOR BASE 1500 BRILHO  
RT73038004S1500.89 **24 €**

**TERMINALES PERFIL BASE CIERRE BRILLO**  
TERMINAIS PERFIL BASE DE FECHO BRILHO  
RGT200029.1 **13 €**

**TERMINALES PERFIL BASE FIJO BRILLO**  
TERMINAIS PERFIL BASE FIXO BRILHO  
RGT200035.1 **12 €**

**TERMINALES PERFIL BASE BRILLO**  
TERMINAIS PERFIL BASE BRILHO  
RT200079.1 **15 €**

**BISAGRA VIDRIO/PARED 90° (SUITE)**  
DOBRADIÇA VIDRO/PAREDE 90°  
RGT53500096.1 BRILLO / BRILHO **75 €**  
RGT53500096.6 NEGRO / PRETO **95 €**

**BISAGRA VIDRIO/VIDRIO 180° (SUITE)**  
DOBRADIÇA VIDRO/VIDRO 180°  
RGT53500097.1 BRILLO / BRILHO **90 €**  
RGT53500097.6 NEGRO / PRETO **110 €**

### PLUS

**CONJUNTO TIRADOR PLUS CORREDERA**  
SET PUXADOR PLUS DE CORRER  
RGT200164.1 BRILLO / BRILHO **55 €**  
RGT200164.19 MATE / MATE **55 €**  
RGT200164.45 BLANCO / BRANCO **55 €**

**CONJUNTO TIRADOR PLUS BATIENTE**  
SET PUXADOR PLUS DE ABRIR  
RGT200171.1 BRILLO / BRILHO **55 €**  
RGT200171.19 MATE / MATE **55 €**  
RGT200171.45 BLANCO / BRANCO **55 €**

<b>CONJUNTO GUIAS INFERIORES DE CRUCE</b>		
SET GUIAS INFERIORES DE CRUZAMIENTO		
RGT200160.1	BRILLO / BRILHO	17 €
RGT200160.19	MATE / MATE	17 €
RGT200160.45	BLANCO / BRANCO	17 €

<b>BURLETE VIERTEAGUAS PLUS 998MM</b>	
BORRACHA VERTE AGUAS 998MM	
RT520528S010998.32	20 €

## TECHNIC / PLUS

<b>CONJUNTO BARRA 1000</b>		
SET BARRA 1000		
RT3S00351000.89	BRILLO / BRILHO	22 €
RT3S00351000.20	MATE / MATE	22 €
RT3S00351000.45	BLANCO / BRANCO	22 €

<b>CONJUNTO SOPORTES TIRANTE</b>		
SET SUPORTES BARRA		
RGT200033.1	BRILLO / BRILHO	19 €
RGT200033.19	MATE / MATE	32 €
RGT200033.45	BLANCO / BRANCO	32 €

<b>2 SOPORTES RODAMIENTO COLINEALES</b>		
SET 2 SUPORTES ROLAMENTOS COLIANEALES		
RT9900021.1	BRILLO / BRILHO	46 €
RT9900021.19	MATE / MATE	46 €
RT9900021.45	BLANCO / BRANCO	46 €

<b>2 SOPORTES CORTOS RODAMIENTO</b>		
SET 2 SUPORTES ROLAMENTOS CURTOS		
RT9900002.1	BRILLO / BRILHO	43 €
RT9900002.19	MATE / MATE	43 €
RT9900002.45	BLANCO / BRANCO	43 €

<b>2 SOPORTES LARGOS RODAMIENTO</b>		
SET 2 SUPORTES ROLAMENTOS LONGOS		
RT9900003.1	BRILLO / BRILHO	49 €
RT9900003.19	MATE / MATE	49 €
RT9900003.45	BLANCO / BRANCO	49 €

<b>2 SOPORTES RODAMIENTO (MODELO CC24)</b>		
SET 2 SUPORTES ROLAMENTOS (MODELO CC24)		
RT9900004.1	BRILLO / BRILHO	55 €
RT9900004.19	MATE / MATE	55 €
RT9900004.45	BLANCO / BRANCO	55 €

<b>2 PATINES CORTOS</b>		
SET 2 PATINS CURTOS		
RT9900010.11	BRILLO / BRILHO	20 €
RT9900010.19	MATE / MATE	20 €
RT9900010.45	BLANCO / BRANCO	20 €

<b>2 PATINES LARGOS</b>		
SET 2 PATINS CURTOS		
RT9900011.1	BRILLO / BRILHO	20 €
RT9900011.19	MATE / MATE	20 €
RT9900011.45	BLANCO / BRANCO	20 €

<b>2 PATINES MR (MODELO CC24)</b>		
SET 2 PATINS (MODELO CC24)		
RT9900012.1	BRILLO / BRILHO	24 €
RT9900012.19	MATE / MATE	24 €
RT9900012.45	BLANCO / BRANCO	24 €

<b>BURLETES DE CRUCE (2 UDS) 2000MM)</b>		
BORRACHAS DE CRUZAMIENTO (2 UDS) 2000MM		
T994250500		40 €

<b>BURLETE MAGNÉTICO RECTO 2200MM</b>		
BORRACHA MAGNETICA RECTA 2200MM		
RGT5200842200.32		20 €

<b>CONJUNTO BURLETES MAGNÉTICOS 90° 2000MM</b>		
SET BORRACHAS MAGNETICAS 90° 2000MM		
RT3S00372000.3232		38 €

<b>JUNTA PARA PUERTA CORREDERA</b>		
UNIÃO PARA PORTA DE CORRER		
RGT5100224.9		8 €

<b>BISAGRA DERECHA</b>		
DOBRADIÇA DEREITA		
RT9900007.1	BRILLO / BRILHO	33 €
RT9900007.19	MATE / MATE	28 €
RT9900007.45	BLANCO / BRANCO	28 €

<b>BISAGRA IZQUIERDA</b>		
DOBRADIÇA ESQUERDA		
RT9900006.1	BRILLO / BRILHO	33 €
RT9900006.19	MATE / MATE	28 €
RT9900006.45	BLANCO / BRANCO	28 €

<b>UP-DOWN</b>		
UP-DOWN		
RGT5100157.9		9 €

<b>BISAGRA ELEVADOR IZQUIERDA</b>		
DOBRADIÇA ELEVADOR ESQUERDA		
RGT4L0586.67		11 €

<b>BISAGRA ELEVADOR DERECHA</b>		
DOBRADIÇA ELEVADOR DEREITA		
RGT4R0586.67		11 €

## TECHNIC

<b>CONJUNTO TIRADOR</b>		
SET PUXADOR TECHNIC		
RGT200031.1	BRILLO / BRILHO	22 €
RGT200031.19	MATE / MATE	22 €
RGT200031.45	BLANCO / BRANCO	22 €

<b>BURLETE VIERTEAGUAS 998MM PARA BATIENTES</b>		
BORRACHA VERTE AGUAS 998MM PARA PORTAS DE ABRIR		
RT520506S010998.32	BRILLO / BRILHO	20 €

<b>SOPORTE TIRANTE-CRISTAL ELEVADO (LATERAL DLP1) (TECHNIC)</b>		
SUPORTE BARRA-VIDRO ELEVADO (LATERAL DLP1)		
RT53500242.1	BRILLO / BRILHO	45 €

## B-SMART

<b>CONJUNTO RUEDAS (1 PUERTA)</b>		
JOGO DE RODAS (1 PORTA)		
RGT4S0565		30 €

<b>BURLETES DE CRUCE</b>		
BORRACHAS DE CRUZAMIENTO		
RGT3S08121950.32		36 €

<b>PERFIL VIERTEÁGUAS (1 PUERTA)</b>		
PERFIL VERTE ÁGUAS		
RGT3S08130696.32		18 €

<b>CONJUNTO MAGNÉTICOS (MODELO BSACX4)</b>		
JOGO MAGNÉTICOS (MODELO BSACX4)		
RGT3S08141950.32		42 €

<b>CONJUNTO MAGNÉTICOS (MODELO BSDCE2)</b>		
JOGO MAGNÉTICOS (MODELO BSDCE2)		
RGT3S08151950.32		21 €

<b>CONJUNTO TAPETAS</b>		
JOGO TAPETAS		
RGT4S0566		22 €

<b>CONJUNTO TIRADOR (1 PUERTA)</b>		
JOGO PUXADOR (1 PORTA)		
RGT4S0567		18 €

<b>CONJUNTO BARRA 1000 BRILLO (MODELO BSWFX1)</b>		
CONJUNTO BARRA 1000 BRILHO (MODELO BSWFX1)		
RGT200223.1		28 €

<b>KIT APLICACIÓN TRATAMIENTO DROP-FREE</b>		
KIT DE APLICAÇÃO TRATAMENTO DROP-FREE		
RT590001342		65 €

# Instrucciones pedido mampara Suite con toallero/s

## Instruções de pedido divisória Suite com toalheiro/s

- 1 Realizar el pedido de la mampara con la codificación estándar siguiendo las pautas que encontrará en la página de la tarifa de la mampara que desea.
- 2 Indicar en el pedido la medida y acabado del toallero escogido. Consultar la tabla de la mampara elegida que designa la medida de toallero adecuada/reco-mendada en función del ancho de la mampara.
- 3 Indicar la altura y la posición del toallero. Es recomendable señalar las medidas en un croquis.

La Oficina Técnica valorará la petición y en el caso de ser viable recibirá una confirmación con un código especial.

**No se podrá añadir toallero posteriormente a haber formalizado el pedido.**

### Consideraciones

Se puede instalar toallero en los fijos que miden como mínimo 500 mm de ancho.

### Modelos WALK IN SUITE

El modelo SIWFX1 incluye de serie un toallero cromado de 400 mm. Puede elegir un toallero de mayor tamaño con un suplemento en el precio indicado en la página de la tarifa dedicada al modelo. En el modelo SIWFM1 el toallero es una opción no incluida en el precio.

La codificación estándar permite indicar la medida del toallero en el último dígito del código.

El toallero irá por defecto centrado en altura y posición. En el caso que se desee instalar a otra altura o posición hay que indicarlo en el pedido. La Oficina Técnica valorará la petición y en el caso de ser viable recibirá una confirmación con un código especial.

- 1 Realizar o pedido da divisória com a codificação standard seguindo as pautas que encontrará na página da tabela de preços da divisória que deseja.
- 2 Indicar no pedido a medida e acabamento do toalheiro escolhido. Consultar a tabela da divisória eleita que designa a medida do toalheiro adequado/recomendado em função do comprimento da divisória.
- 3 Indicar a altura e a posição do toalheiro. Recomendamos assinalar as medidas num esquema.

O Departamento Técnico valorizará o pedido e no caso ser viável receberá uma confirmação com um código especial.

**Não se poderá adicionar o toalheiro posteriormente a ter formalizado o pedido.**

### Considerações

Pode-se instalar o toalheiro nos vidros fixos que medem no mínimo 500 mm de comprimento

### Modelos WALK IN SUITE

O modelo SIWFX1 inclui de série o toalheiro cromado de 400 mm. Pode escolher um tolaheiro mais comprido com um suplemento do preço, indicando na página da tabela ao modelo. No modelo SIWFM1 o toalheiro é uma opção não incluída no preço.

A codificação standard permite indicar a medida do toalheiro no último dígito do código

O toalheiro irá por defeito centrado em altura e posição. No caso de desejar instalar outra altura ou posição terá que indicá-lo no pedido. O Departamento Técnico valorizará o pedido e no caso ser viável receberá uma confirmação.

# Instrucciones mamparas especiales

## Instruções divisórias especiais

### MODIFICACIÓN DE LA MAMPARA MODIFICAÇÃO DA DIVISÓRIA

Encajes o taladros  
Encaixes ou furos

#### Modificación del alto y/o ancho de la mampara

EJEMPLO: FRONTAL + LATERAL

Para mamparas con varios códigos sólo se aplica recargo en el código donde se haga la modificación.

#### Modificação da altura e/ou largura da divisória

EXEMPLO: FRONTAL + LATERAL

Para divisórias com vários códigos só se aplica sobretaxa no código onde se realiza a modificação.

#### Modificación parcial

EJEMPLO: FRONTAL COMPUESTO POR 1 SEGMENTO Y 1 PUERTA

#### Modificação parcial

EXEMPLO: FRONTAL COMPOSTO POR 1 SEGMENTO E 1 PORTA

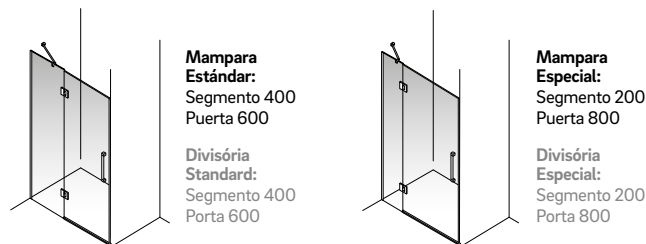

#### Adaptación a movilidad reducida solo TECHNIC batientes

Adaptação a mobilidade reduzida somente TECHNIC de abrir

#### Combinación de cristales en un modelo

EJEMPLO: FRONTAL COMPUESTO POR 1 SEGMENTO Y 1 PUERTA

Se modifica el acabado del cristal en una hoja de la mampara.

#### Combinação de vidros num modelo

EXEMPLO: FRONTAL COMPOSTO POR 1 SEGMENTO E 1 PORTA

Modifica-se o acabamento do vidro numa folha da divisória.

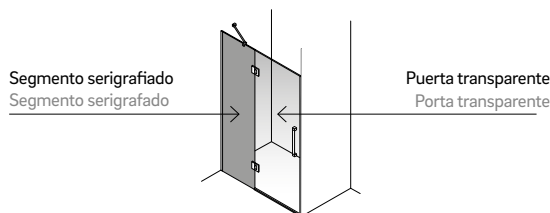

#### Suplementos por embalaje especial

MODELOS WALK-IN FIJOS

CSMADERA1300

#### Suplementos por embalagem especial

MODELOS WALK - IN FIXOS

CSMADERA1400

CSMADERA1500

### INCREMENTOS S/TARIFA AUMENTOS S/TARIFA

**+49 €**

HASTA  
**2200 MM**  
DE ALTURA +**10%** SOBRE P.V.P.  
MEDIDA ESTÁNDAR  
Para otras medidas consultar.

ATÉ  
**2200 MM**  
DE ALTURA + **10%** SOBRE P.V.P.  
MEDIDA STANDARD  
Para outras medidas consultar.

**2201A**  
**2500 MM**  
DE ALTURA +**20%** SOBRE P.V.P.  
MEDIDA ESTÁNDAR  
Para otras medidas consultar.

**2201A**  
**2500 MM**  
DE ALTURA + **20%** SOBRE P.V.P.  
MEDIDA STANDARD  
Para outras medidas consultar.

+**10%** SOBRE P.V.P.  
MEDIDA ESTÁNDAR  
Para otras medidas consultar.

+ **10%** SOBRE P.V.P.  
MEDIDA STANDARD  
Para outras medidas consultar.

+**20%** SOBRE P.V.P.  
MEDIDA ESTÁNDAR  
Para otras medidas consultar.

+ **20%** SOBRE P.V.P.  
MEDIDA STANDARD  
Para outras medidas consultar.

Mismo P.V.P. Que el de toda la mampara en el acabado más caro.

Mismo P.V.P. que de toda a divisória no acabamento mais caro.

1201 - 1300 mm **100€** netos · líquido

1301 - 1400 mm **110€** netos · líquido

1401 - 1500 mm **120€** netos · líquido

# Servicio de montaje e instalación

## Serviço de montagem e instalação

### MONTAJES · MONTAJES

La tarifa recomendada y el código de instalación se encuentran en la página correspondiente de la presente tarifa.

El servicio técnico de **INDUSTRIAS COSMIC, SAU** es la única empresa autorizada para realizar las reparaciones de productos **INDUSTRIAS COSMIC, SAU**. La garantía sobre la instalación será de 3 meses.

**INDUSTRIAS COSMIC, SAU** podrá cobrar el importe de la instalación del producto a través del usuario o del propio distribuidor (esta opción la ha de indicar el distribuidor) siendo éste último el responsable de la realización del pago, sea quien sea quien lo efectúe.

A tabela recomendada e o código para montagem de cada modelo encontram-se na página correspondente da presente tarifa.

O serviço técnico de **INDUSTRIAS COSMIC, SAU** é a única empresa autorizada para realizar as reparações de produtos **INDUSTRIAS COSMIC, SAU**. A garantia da instalação será 3 meses.

**INDUSTRIAS COSMIC, SAU** poderá cobrar o valor da instalação do produto através do utilizador ou do próprio distribuidor (esta opção deve ser indicada pelo distribuidor) sendo este último o responsável pela realização do pagamento, seja quem for que o efetue.

### DESPLAZAMIENTOS · DESLOCAÇÕES

	CÓDIGO	PRECIO · CUSTO
<ul style="list-style-type: none"> <li>Desplazamientos de hasta 25 Kms (sumando la ida y la vuelta desde el Distribuidor) Deslocações até 25 Kms (somando a ida e volta do Distribuidor)</li> </ul>	CSDESPLA25	<b>30 € solo en reparaciones. Includo en el precio de montaje.</b> <b>30 € em reparações. Incluso em custo do montagem.</b>
	CSVISITA	<b>35 € en caso de no efectuarse el montaje</b> <b>35 € em caso de não efectuar a montagem</b>
<ul style="list-style-type: none"> <li>Desplazamientos entre 25 y 50 Kms (sumando la ida y la vuelta desde el Distribuidor) Deslocações entre 25 e 50 Kms (somando a ida e volta do Distribuidor)</li> </ul>	CSDESPLA50	<b>42 €</b>
<ul style="list-style-type: none"> <li>Desplazamientos que superen los 50 Kms (sumando la ida y la vuelta desde el Distribuidor) Deslocações que excedem 50 Kms (somando a ida e volta do Distribuidor)</li> </ul>	CSKILOME	<b>+ 35 € + 0,65 €/km a partir de 50 km a partir de 50 km</b>

### SUPLEMENTOS · SUPLEMENTOS

	CÓDIGO	PRECIO · CUSTO
<ul style="list-style-type: none"> <li>Suplementos por altura especial · Suplemento por altura especial</li> </ul>	CSALTURA	<b>20 € (2100-2200)</b> <b>40 € (2201-2300)</b> <b>60 € (2301-2400)</b> <b>80 € (2401-2500)</b>
<ul style="list-style-type: none"> <li>Segundo operario instalación especial · Segundo operador instalação especial</li> </ul>	CSAYUDANTE	<b>22 € / por hora</b>

### REPARACIONES FUERA DE GARANTÍA · REPARAÇÕES FORA DA GARANTIA

	CÓDIGO	PRECIO · CUSTO
<ul style="list-style-type: none"> <li>Tarifa mínima por servicio · Tabela mínima por serviço</li> </ul>	CSREPARA	<b>42 € + desplazamientos + deslocações</b>
<ul style="list-style-type: none"> <li>Desmontaje de mampara · Desmontagem da divisória</li> </ul>	CSDESMON	<b>50 €</b>

La garantía de una reparación efectuada por **INDUSTRIAS COSMIC SAU** será de 3 meses a partir de la fecha del albarán realizado por nuestro servicio técnico.

A garantia de uma reparaçao realizada pela **INDUSTRIAS COSMIC, SAU** será de 3 meses a partir da data do alvará realizado pelo nossos serviço técnico.

# Tarifa 2022 de instalación de mamparas

## Lista de preços 2022 de instalação de divisórias

TIPOLOGÍA TIPOLOGIA	MODELO MODELO	COLECCIONES COLEÇÕES				
		SUITE	SUPRA2	PLUS	TECHNIC	BSMART
WALK IN BAÑERA WALK IN DE BANHEIRA	2H1 / TH1 / THB		85 €		85 €	
	PHC / PHQ			100 €		
	PHS / THS / THP			90 €	90 €	
WALK IN DE DUCHA WALK IN DE DUCHE	SWM / SW1 / 2W1 / TW1	100 €	100 €		100 €	
	PWC / PWQ			100 €		
	PWS / TWS			100 €	100 €	
	TWT / TWH				100 €	
	TWB				100 €	
MAMPARAS CORREDERAS DIVISÓRIAS CORREDIÇAS	SC2 / PC2 / PB2 / TC2 / TB2	120 €		95 €	95 €	
	SC7 / PC7 / PB7 / TC7 / TB7	145 €		120 €	120 €	
	SCS / PCS / PBS	145 €		120 €		
	SC3 / PC3 / TC3 / TB3	125 €		100 €	100 €	
	SC4 / PC4 / PB4 / TC4 / TB4	130 €		105 €	105 €	
	SC9 / PC9 / PB9 / TC9 / TB9	155 €		130 €	130 €	
	PC5 / TC5			125 €	125 €	
	PCC / TCC			125 €	125 €	
	TC8 / TB8				125 €	
MAMPARAS BATIENTES Y PLEGABLES DIVISÓRIAS ABATÍVEIS OU DOBRÁVEIS	SS1 / TS1	110 €			85 €	
	SS6 / SSU / TS6	135 €			110 €	
	SSD / TSD	115 €			90 €	
	SSE	140 €				
	SSR / SS2 / PS2 / TSR / TS2	115 €		95 €	90 €	
	SST / SS7 / PS7 / TS7 / TSS	140 €		120 €	115 €	
	SS3 / PS3 / TS3	120 €		100 €	95 €	
	PS8 / TS8			125 €	120 €	
	SS4 / PS4 / TS4	125 €		105 €	100 €	
	SS9 / PS9 / TS9	150 €		125 €	125 €	
	TP2				90 €	
	TP7				115 €	
	TPR / TP3				95 €	
	TSB				115 €	
	PS5 / TS5 / TP5			125 €	125 €	
TSC / TSX				125 €		
MAMPARAS EN STOCK DIVISÓRIAS EN STOCK	KH1 / KHB				85 €	
	KHS				90 €	
	KW8 / KW6 / BW1		100 €		100 €	100 €
	BC2					95 €
	BC2+BCL					120 €
	BC5					125 €



N° SIM		MODELO	
FECHA		ACABADOS	

### Mamparas frontales entre paredes para ducha o bañera

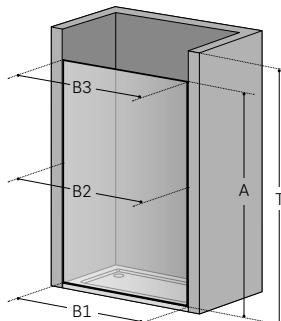

B1		B3	
B2			
A		Altura mampara, si es especial.	
T		Altura techo.	

### Mamparas angulares o frontales con lateral para ducha o bañera

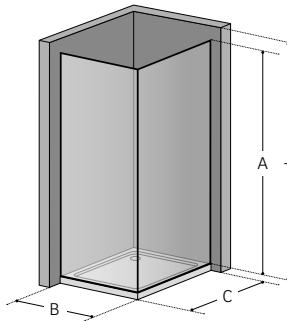

B			
C			
A		Altura mampara, si es especial.	
T		Altura techo.	

### Mamparas cuartocirculares para ducha

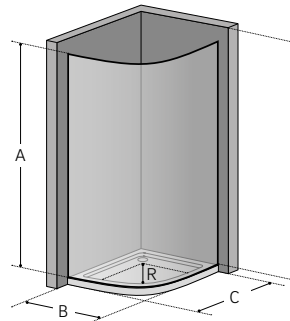

B		C	
A		Altura mampara, si es especial.	
T		Altura techo.	
R		Radio plato.	

### Mampara frontal entre paredes con murete para ducha o bañera

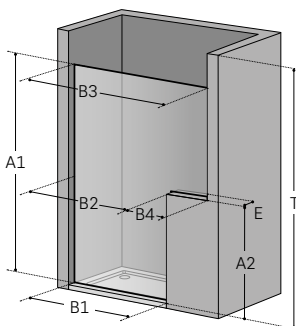

A1		A2	
B1		B2	
B3		B4	
E			
T		Altura techo.	

### Mampara con murete lateral para ducha o bañera

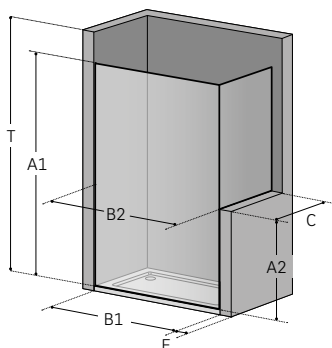

A1		A2	
B1		B2	
E		C	
T		Altura techo.	

Cómo determinar el radio del plato:

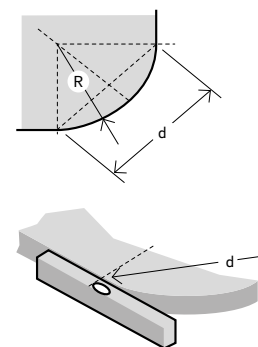

R	d
375	530
505	714
550	779
728	1030

### Referencias de toma de medidas:

<input type="checkbox"/> PLATO STANDARD	<input type="checkbox"/> PLATO OBRA ELEVADO	<input type="checkbox"/> PLATO ENRASADO	<input type="checkbox"/> CENTRADA	<input type="checkbox"/> INTERIOR	<input type="checkbox"/> EXTERIOR

Medidas necesarias a proporcionar (en mm). Siempre desde la parte superior del plato.

Información a rellenar. Enviar a COSMIC por mail a través de nuestra App Android. WhatsApp 691 64 74 40

N° SIM

FECHA

MODELO

ACABADOS

### Otras configuraciones:

(Dibuje un croquis con la configuración de la mampara.)

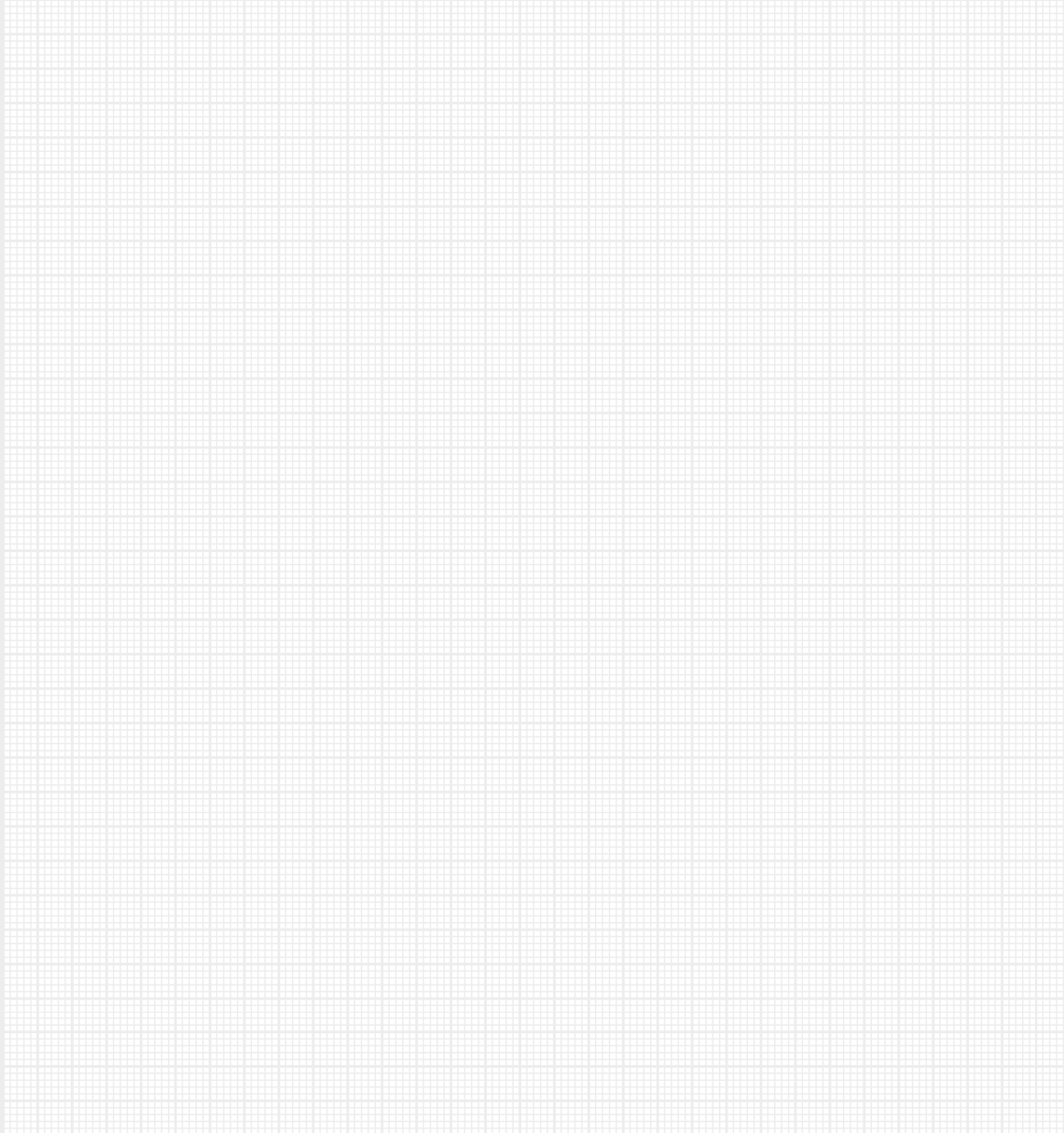

Tubos y ángulos suplementarios disponibles a 1950 y 2500 mm de alto.

40x5

40x10

40x20

40x40

60x40



35x15

40x20

30x30

60x40



Medidas necesarias a proporcionar (en mm). Siempre desde la parte superior del plato.

Información a rellenar. Enviar a COSMIC por mail a través de nuestra App Android.  WhatsApp 691 64 74 40

# Condiciones generales de venta

## 1

Las ventas de INDUSTRIAS COSMIC, S.A.U. se realizan según las condiciones generales aquí expuestas y la entrega de cualquier pedido supone la aceptación, por parte del comprador, de dichas condiciones generales de venta.

## 2

Los productos se pueden modificar, reemplazar o suprimir en todo momento y la información de cualquier naturaleza contenida en nuestros catálogos, tarifas o material publicitario es indicativa.

## 3

Los pedidos recibidos directamente de los clientes o realizados por nuestros representantes en nombre de ellos siempre estarán sujetos a nuestra aceptación. INDUSTRIAS COSMIC, S.A.U. da por confirmados todos los pedidos recibidos y, si no hay notificación específica se entenderán como aceptados.

## 4

Ningún pedido aceptado por nosotros se podrá retractar ni anular sin nuestra aceptación. El cliente, por su parte, no podrá efectuar ninguna devolución de mercancía sin nuestro consentimiento previo. En el caso de anulación o modificación por parte del cliente y por causas ajenas a INDUSTRIAS COSMIC, S.A.U., de un pedido que ya haya sido expedido, se facturará al cliente en concepto de gastos de gestión un importe de 30€ netos (IVA no incluido) para pedidos de accesorios y 50€ netos (IVA no incluido) en caso de mobiliario.

## 5

Forfait gastos de gestión y transporte:

- España peninsular, 5€ para pedidos inferiores a 50€ netos
- Baleares, Andorra y Portugal, 20€ para pedidos inferiores a 400€ netos
- Canarias 60€ para pedidos inferiores a 400€ netos

Forfait aduana:

- Andorra 20€ x pedido
- Canarias despacho de destino e impuestos insulares, por cuenta del destinatario.

Nuestras mercancías serán facturadas según la última tarifa aplicable en el momento del envío. Los precios de esta tarifa no incluyen el IVA.

## 6

INDUSTRIAS COSMIC, S.A.U. ofrece una garantía de 2 años, excepto en los casos indicados en la tarifa, contra todos los defectos de materia prima y fabricación válida a partir del momento de adquisición por parte del cliente final. A fin de determinar la fecha de adquisición será imprescindible la presentación de la factura de compra. Esta garantía consistirá en la sustitución de la pieza que determine su irregular funcionamiento, salvo por razones de uso inadecuado, montaje o instalación incorrectos, mantenimiento indebido, desgaste del uso diario o defectos provocados por reacciones químicas,

electroquímicas o eléctricas. La garantía excluye de responsabilidad a INDUSTRIAS COSMIC, S.A.U. de todas las consecuencias derivadas del funcionamiento o instalación de nuestros productos y esta no reconoce ninguna indemnización por la sustitución de artículos defectuosos ni demanda por daños y perjuicios.

## 7

Nuestras mercancías viajan aseguradas y, en caso de rotura, avería o recepción incompleta del envío, el cliente deberá indicarlo en el albarán de entrega del transporte e informar por escrito a INDUSTRIAS COSMIC, S.A.U. en las 24 horas siguientes a la recepción de la mercancía para poder ejercer la reclamación al transportista.

## 8

INDUSTRIAS COSMIC, S.A.U. intenta siempre reducir al máximo los tiempos de servicio al cliente, ajustándose en lo posible a los requisitos de plazo solicitados expresamente en el pedido y, en caso de no poder satisfacerlos, se enviará una notificación.

## 9

Los productos marca COSMIC, objeto de pedido, se entregarán bajo reserva de dominio a favor de INDUSTRIAS COSMIC, S.A.U. hasta el total cumplimiento de las obligaciones de pago por parte del comprador.

## 10

En caso de impagados, se incurre en un cargo por devolución, más los gastos de financiación actuales en el mercado. INDUSTRIAS COSMIC, S.A.U. se reserva el derecho de retener los pedidos en curso hasta solucionar los efectos pendientes.

## 11

Las disputas referentes a la interpretación o a la ejecución de estas condiciones generales de venta pasarán a ser competencia de los tribunales de nuestra jurisdicción.

## 12

COSMIC aporta la Información de las certificaciones que cumplimos como fabricantes. Es responsabilidad de los instaladores conocer las certificaciones necesarias en cada país.

## Condições gerais de venda

### 1

As vendas das INDUSTRIAS COSMIC, S.A.U. realizam-se segundo as condições gerais aqui expostas e a entrega de qualquer pedido supõe a aceitação por parte do comprador das ditas condições gerais de venda.

### 2

Os produtos estão sujeitos a modificações, a substituição ou suprimento em qualquer momento assim como a informação de qualquer natureza contida nos nossos catálogos, tabelas ou material publicitário é indicativa.

### 3

Os pedidos recebidos directamente dos clientes ou realizados pelos nossos representantes em seu nome estarão sempre sujeitos à nossa aceitação. INDUSTRIAS COSMIC, S.A.U. dá por confirmados todos os pedidos recebidos e se não há notificação específica se entenderão como aceites.

### 4

Nenhum pedido aceite por nós se poderá alterar nem anular sem nossa aceitação. O cliente por sua parte, não poderá efectuar nenhuma devolução de material sem nosso consentimento prévio. No caso de anulação ou alteração ou modificação por parte do cliente e por causas alheias às INDUSTRIAS COSMIC, S.A.U., de um pedido que tenha sido expedido, se facturará ao cliente um custo de 30 € para acessórios e de 50 € para mobiliário ( IVA não incluído ) pelos custos de gestão.

### 5

Custos de gestão e transporte:

- Espanha peninsular, 5€ para encomendas inferiores a 50€ líquido
- Ilhas Baleares, Andorra e Portugal, 20€ para encomendas inferiores a 400€ líquido
- Ilhas Canárias 60€ para encomendas inferiores a 400€ líquido

Gestão aduanas:

- Andorra, € 30 por encomenda
- Ilhas Canárias 30 € x encomenda / Despacho de destino e taxas insulares, por conta do destinatário.

As nossa mercadorias serão facturadas seundo a última tabela aplicável no momento do envio. Os preços de esta tabela não incluem o IVA.

### 6

INDUSTRIAS COSMIC, S.A.U. tem garantia de dois anos excepto nos casos indicados na tabela, contra todos os defeitos da matériaprima e fabrico válido desde o momento da sua aquisição pelo cliente final. A fim de determinar a data de aquisição será imprescindível a apresentação da factura de compra. Esta garantia consistirá na substituição da peça que determine o seu irregular funcionamento, salvo por razões de uso inadequado, montagem ou instalação

incorrectos, desgaste natural, manutenção indevida ou defeitos provocados por reacções químicas, electroquímicas ou eléctricas. A garantia exclui a responsabilidade das INDUSTRIAS COSMIC, S.A.U. de todas as consequências derivadas do funcionamento ou instalação dos nossos produtos e esta não reconhece nenhuma indemnização pela substituição dos artigos defeituosos nem nenhum litígio por danos y prejuízos.

### 7

As nossas mercadorias viajam com seguro e em caso de ruptura, avaria ou recepção incompleta do envio, o cliente deverá indicar a anomalia na guia de entrega e informar por escrito as INDUSTRIAS COSMIC, S.A.U. nas 24 horas seguintes à recepção da mercadoria para poder exercer a reclamação ao transportador.

### 8

As INDUSTRIAS COSMIC, S.A.U. tentarão sempre reduzir ao máximo os tempos de serviço ao cliente ajustando-se na medida do possível ao pedido de prazos solicitados expressamente no pedido e em caso de não os poder satisfazer, faremos emitir uma notificação.

### 9

Os produtos da marca COSMIC, objecto de pedido, entregar-se-ão sob reserva de propriedade a favor das INDUSTRIAS COSMIC, S.A.U. até ao cumprimento integral das obrigações de pagamento por parte do comprador.

### 10

Em caso de não pagamento, incorrem num custo de devolução, mais custos de financiamento actuais aos valores de mercado. As INDUSTRIAS COSMIC, S.A.U. reservam-se no direito de reter os pedidos em curso até à resolução dos efeitos pendentes.

### 11

As dúvidas referentes à interpretação ou execução de estas condições de venda passam a ser da competência de os tribunais da nossa jurisdição.

### 12

COSMIC fornece a informação relativa às certificações que cumprimos enquanto fabricantes. É da responsabilidade dos instaladores conhecer as certificações necessárias em cada país.

# Declaración de conformidad según norma 14428

**COSMIC**



## Declaración de conformidad según norma 14428

**Nombre del suministrador:** Industrias Cosmic S.A.U.

**Dirección:** Polígono Industrial La Borda  
C/Cerdanya, 2, P.O. BOX 184  
08140 Caldes de Montbui (Barcelona)  
Tel. 93 865 42 77 · Fax 93 865 42 64

Declaramos bajo nuestra exclusiva responsabilidad la conformidad de las mamparas de ducha Cosmic.

**Uso previsto:** Higiene personal

**Fabricante:** Industrias Cosmic S.A.U.

**País de fabricación:** España

**Con la norma:**

### **UNE-EN-14428**

Mamparas de ducha · Requisitos funcionales y métodos de ensayo

Siendo los productos conformes con los requisitos de:

- Aptitud para la limpieza.
- Resistencia al choque/propiedades de fractura.
- Durabilidad.

Caldes de Montbui, 17 de Enero de  
2017

**Carles Acensi**  
Gerente Industrias Cosmic,  
SAU

# COSMIC

FECHA DE IMPRESIÓN: JULIO 2022  
FECHA DE IMPRESIÓN: JULHO 2022



**ART DIRECTION**  
COSMIC STUDIO

**GRAPHIC DESIGN**  
ELIPTICGROUP

Ref. 3140999 / ESP-PT

# COSMIC

**INDUSTRIAS COSMIC, S.A.U.**  
**CENTRAL OFFICE & SHOWROOM**  
C. ESQUEIS, S/N · LOCAL 1  
POL. IND. CAN BARRI · P.O. BOX 19  
08415 BIGUES I RIELLS · BARCELONA (SPAIN)  
**CENTRAL OFFICE** TEL +34 938 654 277 · FAX +34 938 654 264  
**SPAIN** TEL 938 664 100 · FAX 938 654 264  
**PORTUGAL** TEL 808 201 454 · FAX +34 938 654 264

info@icosmic.com  
**www.icosmic.com**

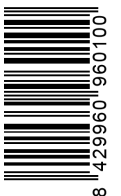

8 429960 960100